



PH: 888.623.4223 THEPERFECTBLOCK.COM

8960 W. LARKSPUR DRIVE, STE. 105  
PEORIA, AZ 85381 INFO@THEPERFECTBLOCK.COM



# JANUARY 2026 EDITION



## ICCF TECHNICAL CONSTRUCTION MANUAL

For additional ICCF construction information using The Perfect Block™ wall systems or questions concerning the EBS ICCF Technical Construction Manual, contact Rick Tindal/EBS VP, Senior Draftsman, & Technical Consultant, M-F, 8am-5pm, @ 623-271-1173, ricktindal@thepperfectblock.com.

For architects and designers specifying The Perfect Block™ in their future designs, CAD details are available by request or by download on our website: ThePerfectBlock.com.

For known block and foundation choices for your future builds, contact Rick for several detail sheets, specific for those block and foundation combinations. Upon request for virtually all building applications using The Perfect Block™, if needed, EBS will create new CAD details for unique applications upon request. All details may be altered as necessary for your unique requirements.

# Eco Building Systems Corp The Perfect Block™

The Perfect Block  
2026 Price List  
Pages 3.10 & 3.11 & 3.11a  
effective 01 November 2023

The Perfect Block™  
Family  
of 7 ICCF Building  
Elements

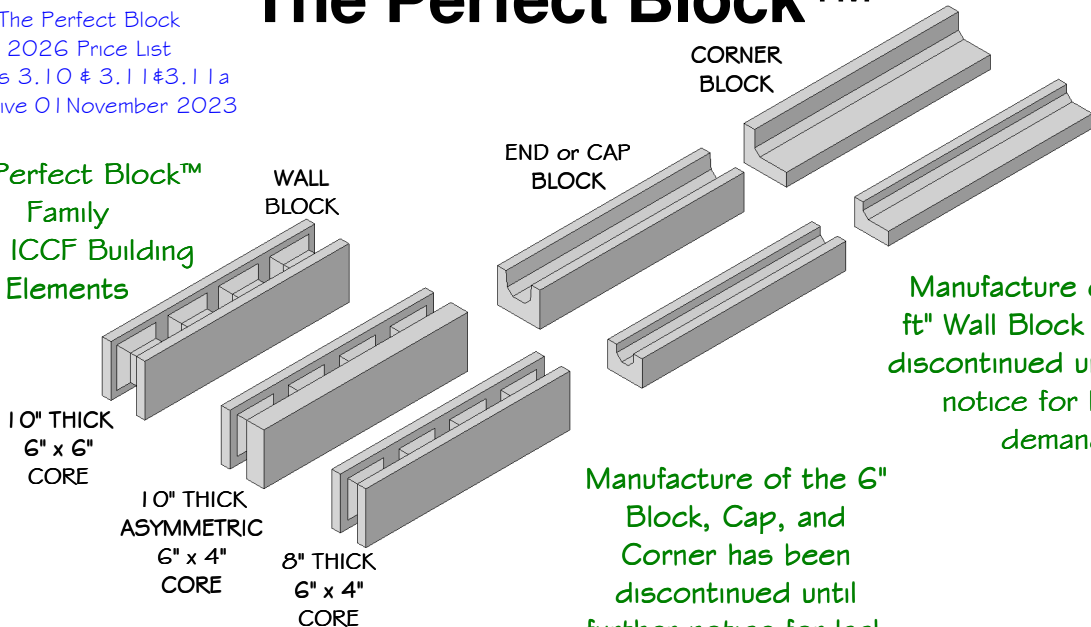

Manufacture of the "2  
ft" Wall Block has been  
discontinued until further  
notice for lack of  
demand.

Manufacture of the 6"  
Block, Cap, and  
Corner has been  
discontinued until  
further notice for lack  
of demand.

# Insulated Composite Concrete Form (ICCF) Technical Construction Manual

## FORWARD

This manual consists of building guides and techniques along with graphic details developed during decades of construction experience using many different insulated concrete form (ICF) designs. It is intended to assist the owner/builder or installation contractor in the methods and details of constructing walls using The Perfect Block™ insulated composite concrete forms (ICCF) building elements from Eco Building Systems Corp. This manual does not preclude the necessity for the installer to use generally accepted construction practices or to follow design plans and specifications developed for your project.

It is the responsibility of the installer, before and during construction, to maintain a working knowledge of the most up to date construction techniques and information available and to work in a safe, efficient, and effective manner to construct walls in accordance with applicable building codes and regulations. Structures built with Eco Building Systems Corp. building elements should be designed, engineered, and constructed in accordance with the applicable governing building codes and regulations including American Concrete Institute (ACI) 318.

Eco Building Systems Corp. will continue to research and develop new innovations that will make our products more energy-efficient, user-friendly, and more cost effective. We reserve the right to modify or to update the products and literature we produce. Therefore, it remains the responsibility of the user to obtain the most recent information available. This manual is generally updated and additions made to it monthly. So, it is prudent to check our website often to ensure you have the most current information. When necessary, please do not hesitate to consult an Eco Building Systems Corp. representative for information concerning the installation of Eco Building Systems Corp. building elements.

We hope this manual will help to show you the advantages of building with Eco Building Systems Corp. building elements and provide ideas and assistance and information for the owner/builder, contractor, architect/designer and engineer and give you peace of mind that you have made the right decision in building with Eco Building Systems Corp. building elements.

Eco Building Systems Corp.  
Management



## **Copyright and Trademark Notice**

This document is developed by Eco Building Systems Corp. It may not be redistributed or modified without prior consent of Eco Building Systems Corp.

## **Disclaimer**

The figures and photos in this manual are for illustration purposes only and are not intended to reflect conditions on your construction site, OSHA regulations, or requirements of local jurisdictions.

The information contained herein is included for illustrative purposes only and, to the best of our knowledge, is accurate and reliable. Any of Eco Building Systems Corp. companies or their representatives cannot, however, under any circumstances make any guarantee of results or assume any obligation in connection with the use of this information. As Eco Building Systems Corp. or its representatives have no control over the use and application to which others may use its products, it is recommended that all applications be in compliance with local building codes and engineering. Responsibility remains with the architect/designer or engineer, contractor and owner for the design, application and proper installation of the product. User shall determine suitability of products for specific application and assume all responsibilities in connection therewith.

## **Warranty**

Manufacturer warrants that, at the time and place shipment is made, the Eco Building Systems Corp. building elements are free from manufacturing defects, of good quality and conform to the published specifications in force at the date of acceptance of the order. THIS WARRANTY SHALL BE EXCLUSIVE AND IN LIEU OF ANY OTHER WARRANTY, EXPRESSED OR IMPLIED, INCLUDING ANY IMPLIED WARRANTY OF MERCHANTABILITY AND FITNESS. As the exclusive remedy for breach of this warranty, defective materials will be replaced, provided, however, that the buyer examine the materials when received and promptly give notice in writing of any defects before the materials are used or incorporated into a structure. Three (3) months after shipment of the materials our warranty and other duties with respect to the quality of the materials delivered shall conclusively be presumed to have been satisfied, all liability therefore terminates, and no action for breach of any such duties may thereafter be commenced.

Any Eco Building Systems Corp. companies or their representatives shall in no event be liable for consequential damages. Unless otherwise agreed in writing, no warranty is made with respect to materials not manufactured by the Eco Building Systems Corp. companies. It cannot be guaranteed nor can any warranty be given for any particular method of use or application or performance of materials under any particular condition. Neither this warranty nor any liability may be extended or amended by any affirmation or promise of the manufacturer or its employees, representatives, or agents by words or action, by any sales information, publication, or drawings.

## Warranty (Cont.)

Due to the potential danger from misuse of the manufacturer's product, manufacturer's warranties of fitness and merchantability as well as any other express warranties made in connection with the sale shall not be effective or actionable unless the goods are used in accordance with the local building codes, code approvals, and good building practices. The manufacturer is relieved of all obligations and liabilities under this warranty, if the building is not constructed in strict accordance with the aforementioned.

# ATTENTION

Changed  
11/08/23

## **EDITOR'S NOTE:**

The purpose of this detailed manual is to present building methods and techniques that we have developed over the decades of ICCF building experience we've had as builders, and now as builders and manufacturers. These techniques have been developed by using time-tested, sensible building methods, trial-and-error, or been hard learned by mistakes we have committed over the years. These lessons learned and mistakes, not repeated, make us the premier ICCF builders that we are today.

To us, it is essential that those building techniques and lessons learned, be passed on to those who purchase and build with The Perfect Block. We devote great energy in providing a comprehensive building guide and updating it almost monthly, so our new ICCF builders do not commit the same mistakes we have in the past, but to use our techniques to have a successful build.

Building with ICCF is simple, but with anything, applying detailed, expert advice, can keep it simple, and minimize mistakes. Please read the building manual (which really means, study the sections for expert guidance). Without expert advice, you will be rolling the dice on what should be a simple build.

Should you not understand something in the manual or need further guidance, please feel free to contact Rick Tindal, 623-271-1173, for free technical consultation.

## WHAT'S NEW RECENT ADDITIONS TO THE MANUAL

	TITLE	PAGES
JANUARY 2026	Added additional Benefits to Consumers	1.4
NOVEMBER 2025	Calculated weights of 100 sf of wall (block plus grout) of each of the ICCF wall blocks	3.2
OCTOBER 2025	Electrical Wire Installation - Text was updated and a photo and Builder's Tip was added	9.1
OCTOBER 2025	Gluing Techniques with Spray Foam Adhesive - Gluing Techniques with Spray Foam Test was added and changed. Links to ordering spray foam adhesive cans were checked and bolded	7.5
MAY 2025	Page was added with photos illustrating nailers for attaching heavy items to ICCF walls.	9.4a
FEBRUARY 2025	Builder's Tip: Research Guidance for European Windows and Doors available in the US	7.13a.8
JANUARY 2025	Expanded Explanation of Foam Adhesive Gluing Technique and Gluing Consumption and Technique Blog Added	7.5
JULY 2024	Gluing Techniques with Spray Foam Adhesive - Gluing Techniques with Spray Foam Adhesive Video Link Added	7.5
JUNE 2024	Roof Construction - Truss to Wall Connection - Roof Construction - Truss to Wall Connection Video Link Added	9.0
APRIL 2024	Differences between Hard Stucco and EIFS Systems - Differences between Hard Stucco and EIFS Systems Article Added	9.6

## TABLE OF CONTENTS

<b>FORWARD</b>	1	
<b>COPYRIGHT AND TRADEMARK, DISCLAIMER, WARRANTY</b>	2	
<b>WARRANTY (cont.), EDITOR'S NOTE</b>	3	Added 2/21/23
<b>TABLE OF CONTENTS</b>	4	
<b>LIST OF FIGURES</b>	7	
<b>LIST OF PHOTOS</b>	9	
<b>1. WHAT IS "THE PERFECT BLOCK™" (TPB)?</b>	1.1	
What is The Perfect Block™ from EBS?	1.1	
Why build with The Perfect Block™?	1.1	
Advantages over traditional "stick framing"	1.1	
Advantages over "white block" ICF	1.2	
Advantages over traditional "gray block" ICCF	1.2	
Advantages over masonry block	1.3	
TPB Benefits for Builders	1.3	
TPB Benefits for Consumers	1.4	
<b>2. TPB PRODUCT LINE OF BUILDING ELEMENTS</b>	2.1	
TPB Product Line of Building Products	2.1	
TPB Block Specifications	2.2	
TPB Block Descriptions	2.3	
TPB Block Descriptions (Cont.)	2.4	
<b>3. TECHNICAL DATA &amp; SPECIFICATIONS</b>	3.1	
TPB Wall Areas and Concrete Consumption	3.1	
TPB (intentionally left blank)	3.2	
TPB 6" Block Specifications	3.3	
TPB 6" End Block Specifications	3.4	
TPB 6" Corner Block Specifications	3.4.1	
TPB 8" Block Specifications	3.5	
TPB 8" End Block Specifications	3.6	
TPB 8" Corner Block Specifications	3.6.1	
TPB 10" Asymmetric Block Specifications	3.7	
TPB 10" End Block Specifications	3.8	
TPB 10" Corner Block Specifications	3.8.1	
TPB 10" 6" X 6" Core Block Specifications	3.9	
TPB 2022 Price List Pg 1	3.10	
TPB 2022 Price List Pg 2	3.11	Changed 1/01/22
<b>4. PLANNING - PLANNING YOUR PROJECT</b>	4.1	
Recommended Tools and Supplies	4.1	

## TABLE OF CONTENTS (cont.)

Guidance and Information for Use of Recommended Tools	4.1	
Estimating Materials for Your Wall Project	4.3	
Example Project Building	4.3	
Estimating TPB Needed	4.5	
Estimating TPB End Block Needed	4.6	
Estimating Rebar Needed	4.7	
Estimating Concrete Grout Needed	4.9	
Final Materials Estimate for Example Project	4.11	
<b>5. PLANNING</b>	<b>5.1</b>	
<b>FOUNDATION DESIGN CHOICES</b>	<b>5.1</b>	
TPB Stem Wall & Slab	5.1	
Modified TPB Stem Wall & Integrated Slab	5.2	
TPB Wall W/ Concrete Stem Wall & Slab	5.3	
TPB Wall W/ CMU Stem Wall & Slab	5.4	
TPB Wall W/ Monolithic Slab & Ftg	5.5	
TPB Basement Wall W/ Monolithic Ftg	5.6	
TPB Wall W/ Garage Stem Wall Ftg	5.7	
<b>DELIVERY &amp; UNLOADING BLOCK</b>	<b>5.8</b>	
Unloading, Techniques, Tips, and Requirements	5.8	
<b>6. FOUNDATION CONSTRUCTION</b>	<b>6.1</b>	
Foundation Requirements	6.1	
Footing Layout	6.1	
Footing Construction	6.2	
Footing and Stem Wall Construction	6.3	Added 9/06/21
Creating a Brick Ledge	6.5	Added 9/07/21
Waterproofing - Below Grade	6.5f	Added 12/29/22
<b>7. WALL CONSTRUCTION</b>		
Wall Layout	7.1	Changed 6/04/22
Wall Construction Photos	7.1a	
EBS Manufacturer's Recommended Notes to be Added to the Construction Documents	7.1.3	
Marking Corners	7.2	
Setting The First Course of Blocks	7.3	
Setting the Last Block of the First Wall	7.3	
Setting Second Course and Subsequent Courses of Block	7.4	
Creating Door and Window Openings		
Staging Materials and Preparing Work Area		
Constructing First Corner		
Gluing Techniques with Spray Foam Adhesive	7.5	Changed 6/04/22
Corner Construction Images	7.6	
Corner Staple Fabrication	7.7.1	Added 6/04/22
ICCF Wall "T" Intersection Construction	7.7.2	Added 7/28/21

## TABLE OF CONTENTS (cont.)

45 Degree Corner Wall Construction	7.7.3	Added 8/9/23
Installing EBS Block Vertically	7.8	
Creating Curved Walls	7.8	
Placing Rebar in a Curved Wall	7.12	
Round Wall Photo Gallery	7.12a	
Rebar Placement around Openings	7.13	
Supporting Openings	7.13	Added & Changed 8/13/24
Openings and Bucks	7.13	
Buck Methods	7.13a	
Builder's Tip: European Windows and Doors Research Guidance	7.13a.8	Added 2/14/25
Garage Door Track Nailer Installation	7.13b	
Garage Door Opening Buck - Concrete Stop & Lintel Support	7.13c	
Creating Reinforced Lintels and Headers	7.14	
Creating Reinforced Lintels and Headers (Cont.)	7.16	
Adding Ledgers	7.18	
Installing a Ledger	7.18	Added 3/23/21
Installing Trusses in Wall Pockets (without a Ledger)	7.24a	
Bracing the Walls	7.25	
Pre-Grout Bracing Inspection	7.25	Added 3/16/21
Simple Wall Strengthening Methods (Buttresses and Pilasters)	7.30	
Simple Forming for Stand-Alone Concrete Columns	7.33	
Simple Forming for Stand-Alone "Square" Concrete Columns	7.33a	Added 4/26/23
Free Standing 6' 8" Blk Fence Wall - Zero Property Line Detail	7.34	
Free Standing 6' Combo 10' & 6" Blk Fence Wall - Zero Property Line Detail	7.35	
<b>8. GROUTING</b>	<b>8.1</b>	
Grouting	8.1	
Post Grouting	8.2	
Pre-Grout Checklist	8.3	
<b>9. WALL CONSTRUCTION - POST GROUT</b>	<b>9.0</b>	
Roof Construction - Truss to Wall Connection	9.0	Added 6/28/24
Electrical Wire Installation	9.1	
Electrical Conduit Installation	9.2	
Plumbing Installation	9.2	
Wall Attachments and Finishes	9.3	Added 4/17/24
Differences between Hard Stucco and EIFS Systems	9.6	
Fireproof ICCF Roof & Eave Construction	9.8	
Fireproof ICCF Roof & Eave - 10" Asymmetric Full Block Roof (Detail)	9.9	
Fireproof ICCF Roof & Eave - Half Block/Concrete Slab Roof (Detail)	9.10	
Fireproof ICCF Roof & Eave - 10" Asym Full Block/Exposed Trusses (Detail)	9.11	
Fireproof ICCF Flat Roof - Half Block/Concrete Slab Roof (Detail)	9.12	
B-Deck Concrete Floor Photo Examples - Root Cellar	9.12a	

## TABLE OF CONTENTS (cont.)

10. EPILOGUE	10.1
11. ICCF PHOTO GALLERY & IDEA SECTION (Removed and placed on our website and in a photo handout to reduce megabyte size of the manual) Examples of ICCF projects and builds and unique creations in ICCF block from owner/builders and contractors. Please contact me, Rick Tindal, 623-271-1173, ricktindal@thepperfectblock.com if you did not receive a Photo Gallery Handout	11.0

Removed  
and  
placed in  
handout  
10/25/22

## LIST OF FIGURES

Figure 1.1	10" TPB Block Wall Cutaway Drawing	1.1.1
Figure 2.1:	TPB Product Line 3D Images	2.1
Figure 2.2:	TPB Specifications	2.1
Figure 3.1:	TPB 3D Images Technical Data & Specifications	3.1
Figure 3.2:	Page Intentionally Left Blank	3.2
Figure 3.3:	TPB 6" Block Specifications	3.3
Figure 3.4:	TPB 6" End Block Specifications	3.4
Figure 3.5:	TPB 8" Block Specifications	3.5
Figure 3.6:	TPB 8" End Block Specifications	3.6
Figure 3.7:	TPB 10" Asymmetric Block Specifications	3.7
Figure 3.8:	TPB 10" End Block Specifications	3.8
Figure 3.9:	TPB 10" 6X6 Core Block Specifications	3.9
Figure 3.10:	2020 Price List Page 1	3.10
Figure 3.11:	2020 Price List Page 2	3.11
Figure 3.12:	Page Intentionally Left Blank	3.12
Figure 3.13:	Page Intentionally Left Blank	3.13
Figure 4.1:	Drawing: Example Building	4.3
Figure 5.1:	Detail: TPB STEM WALL & SLAB	5.1
Figure 5.2:	Detail: MODIFIED TPB STEM WALL & INTEGRATED SLAB	5.2
Figure 5.3:	Detail: TPB WALL W/ CONCRETE STEM WALL & SLAB	5.3
Figure 5.4:	Detail: TPB WALL W/ CMU STEM WALL & SLAB	5.4
Figure 5.5:	Detail: TPB WALL W/ MONOLITHIC SLAB & FOOTING	5.5
Figure 5.6:	Detail: TPB BASEMENT WALL W/ MONOLITHIC FOOTING	5.6
Figure 5.7:	Detail: TPB WALL W/ GARAGE STEM WALL FOOTING	5.7
Figure 6.1:	Drawing: 3-4-5 TRIANGLE METHOD	6.1
Figure 6.2:	Drawing: PYTHAGOREAN THEOREM Right Triangle Method	6.2
Figure 6.3:	Drawing: DIAGONAL SQUARING	6.2
Figure 6.4a:	Detail: FOOTING & STEM WALL CONSTRUCTION View 1	6.4
Figure 6.4b:	Detail: FOOTING & STEM WALL CONSTRUCTION View 2	6.5
Figure 7.1:	Detail: TPB 8" BLOCK FIRST COURSE PLACEMENT	7.1
Figure 7.1.1:	Detail: TPB 8" BLOCK FIRST COURSE OFFSET	7.1a
Figure 7.2:	Detail: MARKING CORNERS	7.2
Figure 7.3:	Detail: TPB 8" BLOCK CORNER CONSTRUCTION	7.6
Figure 7.4:	Image: TPB 8" First Course Corner Construction	7.7
Figure 7.5:	Image: TPB 8" Corner Construction	7.7
Figure 7.6:	Image: TPB 8" Corner Construction and Other Building Components	7.7
Figure 7.7:	Image: TPB Curved Wall Photo	7.8
Figure 7.8:	Table: Curved Wall Standard Radii Reference Table	7.9

Changed  
6/04/22

## LIST OF FIGURES (cont.)

Figure 7.9:	Detail: EXAMPLE 3' RADIUS WALL USING 8" TPB WALL BLOCK	7.10
Figure 7.10:	Detail: EXAMPLE 3' RADIUS WALL USING 8" TPB WALL BLOCK	7.11
Figure 7.11:	Image: TPB Curved Wall	7.12
Figure 7.12:	Image: TPB Curved Wall	7.12
Figure 7.14a:	Detail: TPB 8" BLOCK 2-COURSE LINTEL DETAIL	7.14
Figure 7.14b:	Detail: TPB 8" BLOCK 3-COURSE LINTEL DETAIL	7.15a
Figure 7.14c:	Detail: LINTEL 1 - FOR SPANS 6'-3' OR UNDER	7.15b
Figure 7.14d:	Detail: LINTEL 2 - FOR SPANS 18'-0" OR UNDER	7.15c
Figure 7.15:	Detail: A FRAME LEDGER SUPPORT	7.19
Figure 7.16:	Detail: TPB BLOCK LEDGER SECTION AND ELEVATION	7.20
Figure 7.17:	Detail: TPB 8" BLOCK - LEDGER TO OPEN WEB TRUSS	7.21
Figure 7.18:	Detail: TPB 8" BLOCK - LEDGER TO PARALLEL TRUSS	7.22
Figure 7.19:	Detail: TPB 8" BLOCK - LEDGER TO I-JOIST	7.23
Figure 7.20:	Detail: TPB CURVED WALL LEDGER & TOP PLATE	7.24
Figure 7.21:	Detail: TYPICAL TEMPORARY PRE-GROUT BRACING METHOD	7.26
Figure 7.22:	Detail: EXTRA SECURE TEMPORARY PRE-GROUT BRACING METHOD	7.27
Figure 9.1:	Detail: ELECTRICAL ICCF INSTALLATION/PLACEMENT	9.1a
Figure 9.2:	Detail: PLUMBING ICCF INSTALLATION/PLACEMENT	9.2a
Figure 9.3:	Detail: STUD WALL ATTACHMENT TO ICCF WALL	9.3
Figure 9.4:	Detail: "LET-IN" NAILER	9.5
Figure 9.4a:	Detail: "LET-IN" NAILER - THREADED ROD AND SCAB	9.5

## LIST OF PHOTOS

This Sheet is Under Construction

### **WALL CONSTRUCTION**

Photo 7.1:	First Course Construction - Block Placement	7.1.1
Photo 7.2:	First Course Construction - Block Placement	7.1.1
Photo 7.3:	First Course Construction - Block Placement	7.1.1
Photo 7.4:	First Course Construction - Level & Plumb Block	7.1.1
Photo 7.5:	First Course Construction - Level & Plumb Block	7.1.1
Photo 7.6:	First Course Construction - Level & Plumb Block	7.1.1
Photo 7.7:	First Course Construction - Corner Construction	7.1.2
Photo 7.8:	Second Course	7.1.2

## WHAT IS "THE PERFECT BLOCK™" (TPB)?

### What is "The Perfect Block™"?

"The Perfect Block™" is an insulated composite concrete form (ICCF) system made of a mixture of ground-up clean post-industrial, post-consumer expanded polystyrene (EPS) also commonly known as "Styrofoam®", cement, and proprietary admixtures and water. 100% of the EPS in an ICCF block is recycled EPS that was destined to be dumped in a landfill. And 87% of the volume of each TPB block is recycled EPS. The EPS is what gives the ICCF block its outstanding insulating properties. We are using a modern era waste product that would be filling the world's landfills to create a much-needed energy efficient building block. When the cores of assembled ICCF blocks are filled (grouted) with concrete and reinforcement steel (rebar), the cured structure provides a permanent framework for a "screen-grid" of reinforced concrete to form highly insulated stem walls, load-bearing walls, shear walls, non-load bearing walls, sound attenuation walls, lintels, perimeter walls, retaining walls, and many other components of a building. TPB is in the family of ICCFs commonly called "gray block". Because ICCF is a composite mixture of ground-up recycled EPS and cement, it has its characteristic gray color which differentiates it from other "white" ICF blocks and is referred to as an insulated composite concrete form (ICCF).

### Why build with "The Perfect Block™" block?

"The Perfect Block™" is a complete low-density insulated composite concrete form (ICCF) wall building system with significant advantages over traditional wood "stick framing" construction and with other insulated concrete form (ICF) systems or concrete masonry units (CMU) block.

#### Advantages over traditional "stick framing" construction

- Strength - ICCF walls are at least 700% stronger than stick or metal stud framed walls
- Insulation - A 10" ICCF wall has no thermal bridges at least 4 times greater thermal resistance than 2x6 batt insulated walls
- Thermal Mass - ICCF wall thickness and density further enhance thermal resistance over stick or metal stud framing providing a "thermal mass multiplier" that further resists energy loss or gain
- Fire Resistance - ICCF walls do not burn. "The Perfect Block™" has a 4-hour fire rating from Intertek Testing
- Termite/Insect Resistance - ICCF walls have no wood inside. There is no food source for termites or boring insects or rodents. Rodents won't nest in it  
\* If wood stay-in-place "bucks" are used as nailers for windows and doors, the wood will be pressure treated
- Design Versatility - ICCF wall material can be easily cut and shaped with common carpentry tools into infinite and unique design features for load and non-load bearing walls

## THE PERFECT BLOCK™ (TPB)

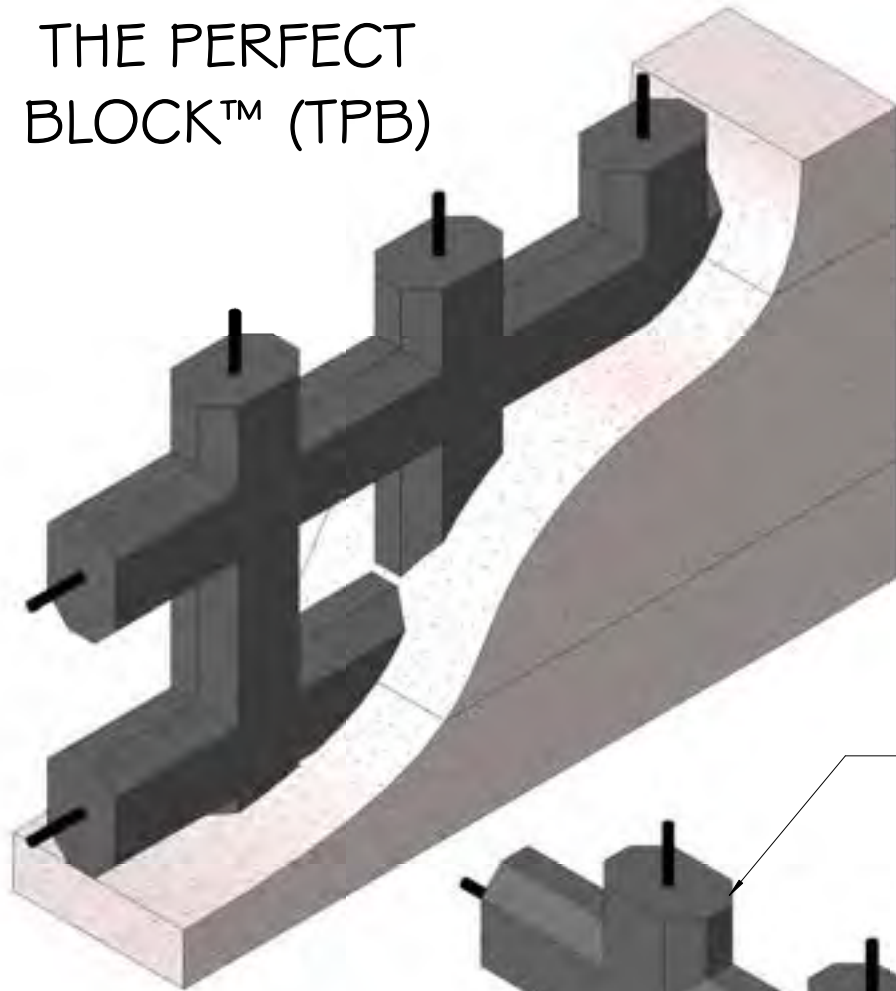

POURED CONCRETE (GROUT) IN ALL VERTICAL AND HORIZONTAL BLOCK CORES WITH REBAR CENTERED IN EACH CORE

AN ICCF WALL CUTAWAY - SHOWING A 2' X 3' PORTION OF A 10" ASYMMETRIC TPB ICCF WALL THAT HAS BEEN "GROUTED" AND THEN PART OF THE FORM REMOVED, EXPOSING THE "SCREEN-GRID" INTERNAL CONCRETE AND REINFORCING STEEL GRID STRUCTURE WITH A REINFORCED CONCRETE COLUMN AND A REINFORCED CONCRETE BEAM EVERY 12" ON CENTER WITHIN, THROUGHOUT THE ENTIRE ICCF WALL

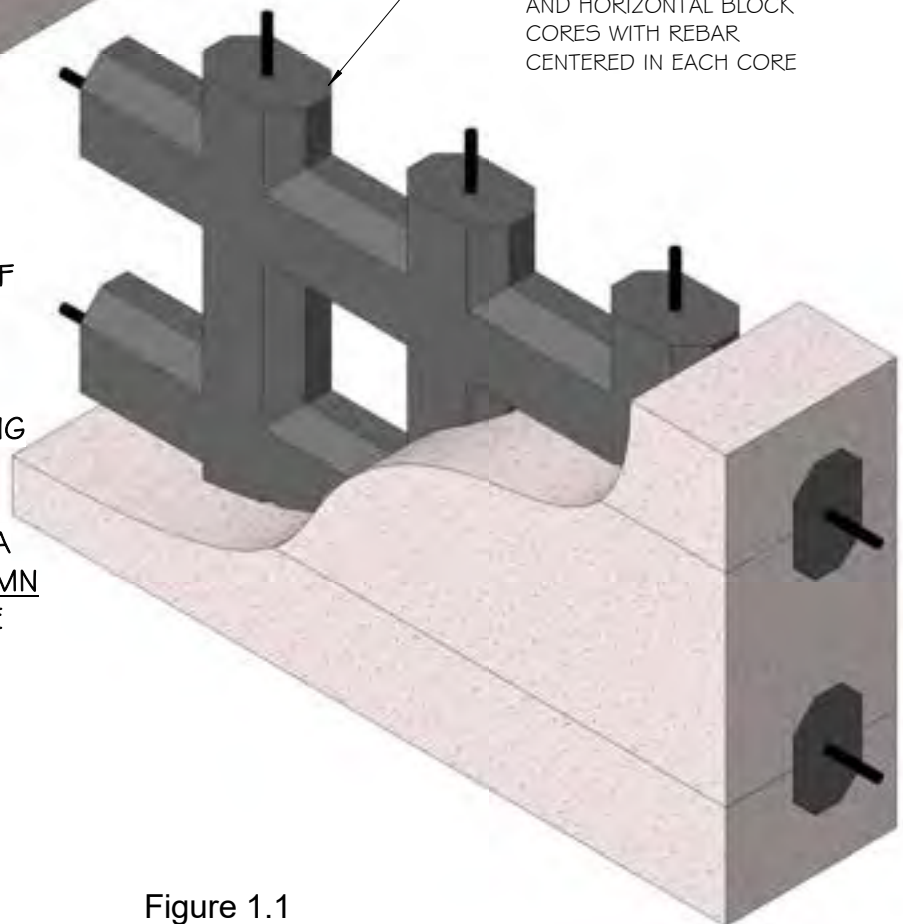
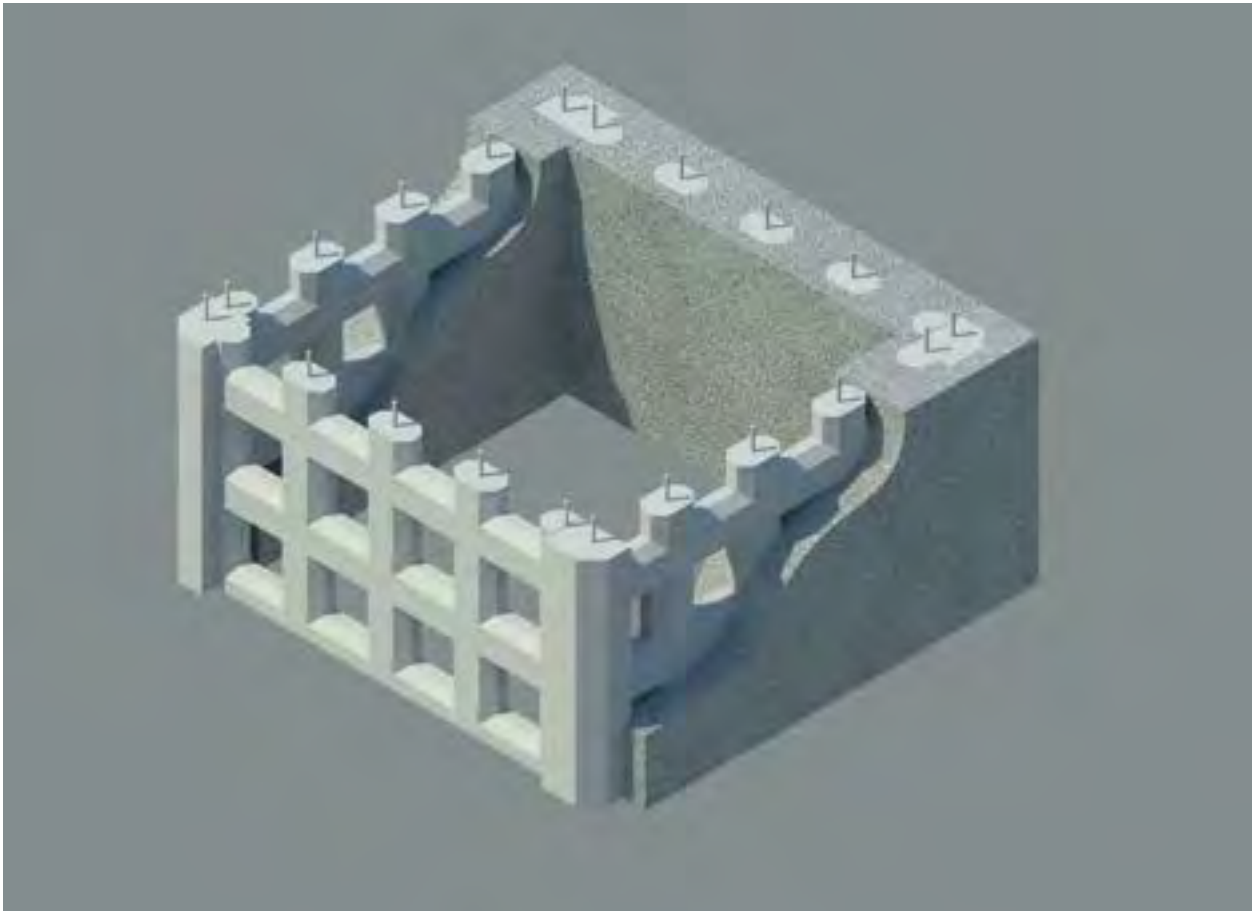

Figure 1.1



This rendering, with portions of the ICCF form material removed, illustrates the structural components of the monolithic screen-grid steel-reinforced concrete columns and beams at 12" on center, formed by grouting with concrete, the internal cores of the insulated forms. Notice the stout concrete column formed at each corner of the structure when forming the "no cut" corners with the ICCF corner blocks.

Figure 1.2

## WHAT IS THE PERFECT BLOCK™ (TPB)? (Cont.)

### Advantages over "white block" ICF

- TPB is the "greener choice" - White block is made of virgin molded EPS. There is little, if any recycled material in White block. In strict contrast to White block, each TPB has nearly 87% of its volume made of only 100% clean recycled EPS greatly reducing waste that was headed for the landfill.
- TPB has "teeth", white block doesn't - "Tooth" is a term to describe a surface's ability to hold or grip a substrate. TPB's inherent textured (slightly rough) cementitious surfaces can hold cementitious exterior stuccos and interior plasters or drywall joint compound or adhesives without additional furring, layer of rigid foam or wire lath and tar paper, or house wrap eliminating many costly additional materials and labor-intensive steps required with other building materials to clad exterior and interior walls. White block has no "tooth" and requires furring and/or secured wire lath to cover with plaster or stucco.
- TPB surfaces can remain exposed for years without UV radiation exposure damage. In contrast, white block is vulnerable to UV radiation deterioration almost immediately and must be covered soon after construction to prevent UV radiation deterioration and mechanical damage.
- TPB requires minimal or no bracing - White block is super lightweight and a significant investment in erection and dismantling time and high rental fees or purchase costs for bracing materials and scaffolding is required to brace white block walls before grouting in order to be safe and achieve a high-quality wall that is plumb and straight and prevent the blocks from "floating" when wet concrete is poured into the blocks. The precision made TPB is denser and stronger and requires no or minimal bracing to create plumb, level, and straight walls saving time and money and TPB will not "float".

### Advantages over traditional "gray block" ICF

- Consistent size, shape, and weight - TPBs are monolithic and mold formed under pressure and under strict quality control. Therefore, each TPB is identical to the next, allowing for easy stacking with minimal shimming and gluing and making it easier to construct plumb and level walls, saving time and materials.
- 12" core spacing - TPB cores are spaced 12" on center. This allows for increased wall strength with a tighter screen-grid pattern for concrete and rebar. Any cut block 12" or greater in length can be used for primary wall construction greatly minimizing waste.
- Several Block Sizes to Choose - TPBs come in many sizes and insulation thicknesses to optimize the builder's desires and requirements.

## WHAT IS THE PERFECT BLOCK™ (TPB)? (Cont.)

### Advantages over masonry block

- Ease of Construction - The improved size and reduced weight of a 4' block over longer and heavier blocks that require more than one person to stack greatly ease handling and assembly, saving labor, time, and materials. Because the blocks are actually forms for reinforced concrete which provides all the structure in a wall, there is no need for stacking the blocks in a "running bond" like masonry blocks. TPB can be stacked evenly above each block in the previous block course ("stack bond") saving time used for additional measuring.
- Building with TPBs require no special labor skills - Building with masonry block requires skilled labor. In contrast, building with TPB can be performed by anyone with limited skills. Because of its larger but manageable size to masonry blocks, constructing with TPB will not only save you many hours of labor during the building process but can be a great experience easily building your own house.
- No clean-outs needed - Most debris created during construction is EPS beads and cement dust which is lightweight and can easily be removed with compressed air before placing corner blocks during final construction.
- No concrete vibration needed - With the proper concrete slump, the grout will flow freely throughout all the grid cores without vibration.
- Reinforcing Bars do not need to be tied - The block cores keep the reinforcement bars in the proper position during the concrete grout pour, eliminating the need for tying.

### TPB Benefits For Builders:

<https://www.youtube.com/watch?v=are1cHzyeWs>

- Engineered to be highly consistent with standard residential construction dimensions
- Forms are precision molded and require minimal shimming for plumb and level walls
- Forms are stout and rigid and create strong straight walls requiring no or minimal pre-grout bracing and will not "float" when grouting
- Forms are large enough to build walls rapidly but small enough for single person handling
- Forms are easily cut with common carpentry tools
- Forms are easily cut for special angles and shapes
- Forms' 12" on center cores allow for any 12" or greater cut block to be used in general construction minimizing leftover building waste
- In addition to a building guide for construction, EBS provides any training required for a successful build project to the contractor and crews as well as the individual owner/builder

## WHAT IS THE PERFECT BLOCK™ (TPB)? (Cont.)

### TPB Benefits For Consumers:

- Cost is highly competitive with wood frame construction
- Structural strength of walls are many times greater than wood frame construction
- Environmentally friendly forms are made with 100% recycled EPS and no wood, saving energy and forests and minimizing wastes
- Higher appraisal values than conventional "stick built" buildings
- 4-hour fire rated, ASTM E119
- Fire insurance rates are lower than wood frame construction
- 250 MPH wind rated, ASTM E330, E1886, E1996, ICC 500
- Forms' textured surfaces eliminate the first layers of traditional exterior and interior wall cladding, saving material costs and labor
- No organic materials in ICCFs to foster mildew growth or provide food sources for boring insects
- No structural damage from wood eating termites, carpenter ants, etc...
- Minimal air infiltration, leaving home cleaner and utility costs lower
- Reduces indoor air pollution and dust allergens
- Heating and cooling costs reduced by 60-80 percent
- Superior performance in hurricane and tornado prone areas and earthquake zones
- Virtually eliminates outdoor noise
- Reduces foundation/basement wall cracking and radon gas infiltration
- Less toxic fume emissions in a fire than wood or most other insulation
- Exceeds all code requirements for flame spread and smoke development
- No CFCs or HCFCs
- No odor or irritating fumes
- ICC-ESR 5765
- Florida Product Approval, FL37198

EBS Fire Resistance YouTubeVideo Link:

<https://www.youtube.com/watch?v=1PyvfU1eavo>

Changed  
1/28/26

## ECO BUILDING SYSTEMS CORP PRODUCT LINE OF BUILDING ELEMENTS

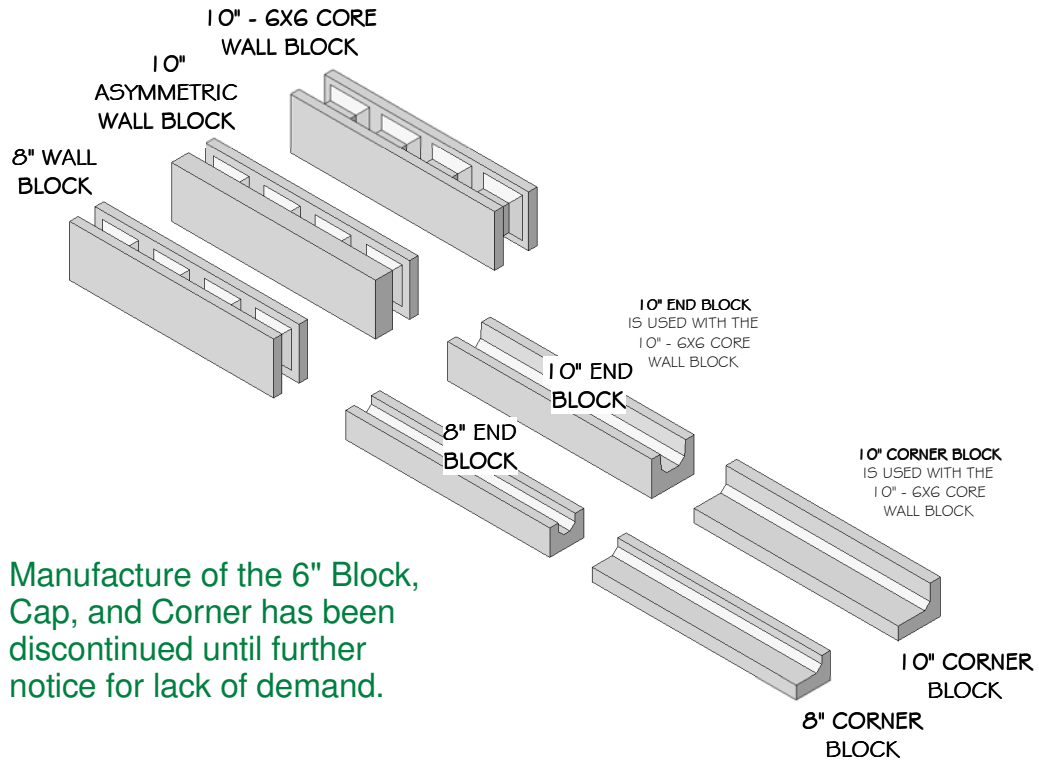

"The Perfect Block™" can be used for highly insulated exterior or interior walls, load-bearing walls, shear walls, non-load bearing walls, sound attenuation walls, lintels, perimeter walls, retaining walls, stem walls and many other components of a building.

Figure 2.1

## EBS BLOCK SPECIFICATIONS

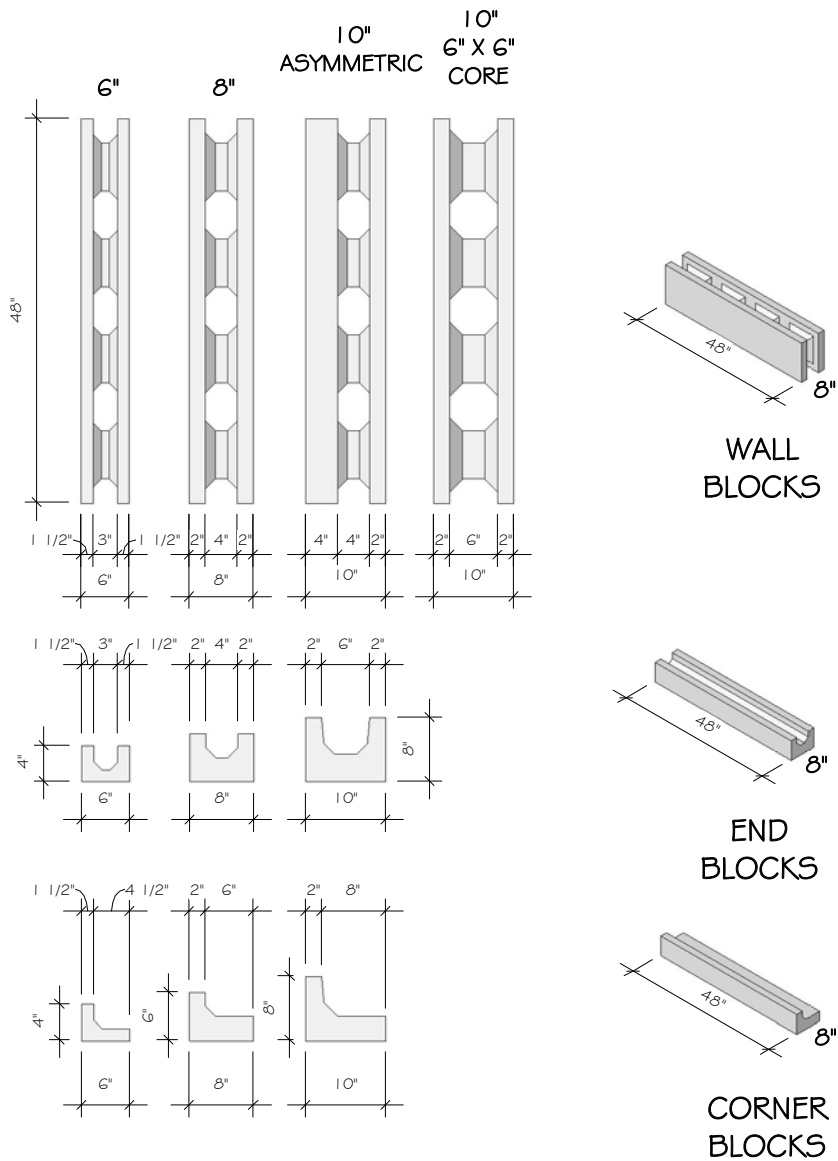

Figure 2.2

## BLOCK DESCRIPTIONS

### **6" INTERIOR WALL & FENCE BLOCK**

The 6" wall and fence block is ideal for building interior walls and outdoor fences. The block has great sound dampening qualities and uses a minimal amount of concrete (grout) reducing construction costs. Sturdy outdoor fences can be built rapidly and the block's construction versatility can create unlimited shapes and curves. The 6" wall block has a 3" x 6" core, 12" on center. A 6" wall can be a load bearing wall, but as a manufacturer of the 6" block, we recommend the block be used for interior partition walls and not the exterior wall supporting the roof.

### **6" INTERIOR WALL & FENCE END BLOCK**

The 6" wall and fence end block compliments the 6" wall block as finish block for wall ends and modified end blocks can be used for wall corner construction.

### **6" INTERIOR WALL & FENCE CORNER BLOCK**

The 6" corner block is used to finish wall corner construction. Before installing a corner, check your wall rebar for proper placement or for missing corner rebar.

### **8" WALL BLOCK**

The 8" wall block is great for load bearing exterior walls and can be used for interior walls and outdoor fences. The 8" wall block is great for load bearing exterior walls, basement walls, stem walls on strip footings, separation walls, short wall buttresses, and multi-story buildings.

### **8" END BLOCK**

The 8" wall end block compliments the 8" wall block as a finish block for wall ends.

### **8" CORNER BLOCK**

The 8" corner block is used to finish wall corner construction. Before installing a corner, check your wall rebar for proper placement or for missing corner rebar.

### **10" ASYMMETRIC WALL BLOCK**

The 10" wall block is great for load bearing exterior walls. The exterior side of the block has a full 4" of rigid insulation and a 2" side of insulation to the interior. Plus the four webs inside the block which are a full 10" thickness of insulation. The additional exterior wall side thickness enhances its insulation values and sound dampening qualities over the 6" and 8" wall blocks.

### **10" END BLOCK**

The 10" wall end block compliments the 10" wall block as a finish block for wall ends.

Changed  
5/7/21

**BLOCK DESCRIPTIONS (Cont.)**

**10" CORNER BLOCK**

The 10" corner block is used to finish wall corner construction. Before installing a corner, check your wall rebar for proper placement or for missing corner rebar.

**10" - 6" X6" CORE WALL BLOCK**

The 10" - 6" X 6" core wall block has 6" x 6" cores, , at 12" on center, each way for a vertical and horizontal concrete grid and is great for load bearing exterior walls where additional strength and resistance is desired, such as for basement walls, stem walls on strip footings, separation walls, short wall buttresses, and multi-story buildings.

Changed  
5/7/21

## TECHNICAL DATA & SPECIFICATIONS\*

EBS 6", 8", 10" ASYM, 10" 6X6 CORE .....

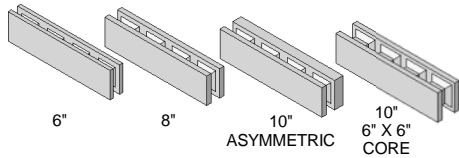

EBS END & CORNER BLOCKS

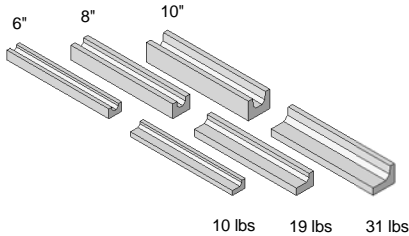

EBS 6" BLOCK .....

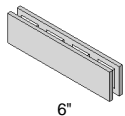

R Value: approximately R16 without adding the thermal mass multiplier from the concrete cores

6"

Weight per block: 30 lbs each

EBS 8", 10" ASYM .....

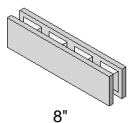

R Value: approximately R24 without adding the thermal mass multiplier from the concrete cores

8"

Weight per block: 45 lbs each

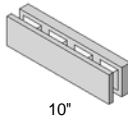

R Value: approximately R32 without adding the thermal mass multiplier from the concrete cores

10"

ASYMMETRIC  
Weight per block: 53 lbs each

EBS 10" 6" X 6" CORE BLOCK .....

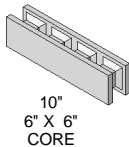

R Value: approximately R26 without adding the thermal mass multiplier from the concrete cores

10"  
6" X 6"  
CORE

Weight per block: 47 lbs each

EBS END BLOCKS .....

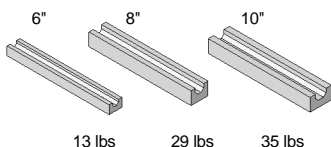

13 lbs

29 lbs

35 lbs

## WALL AREA

4 SQ FT / BLOCK

25 BLOCK / SQUARE (10' X 10' WALL AREA, 100 SQ. FT.)

\* The Perfect Block is a "stay-in-place" form and not a structural block. The form's compressive strength is 56 psi. The actual structural strength of the ICCF wall comes from the cured steel-reinforced concrete fully grouted in the vertical and horizontal cores within the form.

6" END BLK ..... 2 SQ FT / BLOCK (WIDE SIDE)

8" END & CORNER BLK ..... 2.7 SQ FT / BLOCK (WIDE SIDE)

10" END & CORNER BLK ..... 3.3 SQ FT / BLOCK (WIDE SIDE)

## CONCRETE CONSUMPTION\*

.62 CU YD / SQUARE

(10' X 10' WALL AREA  
100 SQ. FT.)

.85 CU YD / SQUARE

(10' X 10' WALL AREA  
100 SQ. FT.)

1.31 CU YD / SQUARE

(10' X 10' WALL AREA  
100 SQ. FT.)

\* Concrete consumption numbers are precise. We recommend adding 5% extra concrete to your calculations when ordering concrete so you don't come up short or to cover contingencies. If you have leftover concrete, don't waste it. See Grouting section in this manual for suggestions.

Added  
3/16/21

## END BLOCKS USED AS A WALL END

6" END - .22 CU FT / BLOCK

8" END - .31 CU FT / BLOCK

10" END - .39 CU FT / BLOCK

Figure 3.1

### Recommended Grout Order for Concrete Batch Plant:

Order a "grout mix", "flowable", at an EBS recommended minimum 3000 psi (IRC Code: Minimum 2500 psi), aggregate less than 3/8" (pea gravel preferred), and an 8" to 10" slump (the higher the slump, the more fluid the grout).

If your local batch plant has difficulty providing a grout mix, here's the recipe for a 3000 psi grout mix from Arizona Materials in Phoenix that you can provide them:

560 lbs of cement, 130 lbs of fly ash, 2190 lbs of sand, 710 lbs of 3/8" aggregate (pea gravel preferred), 350 lbs of water for 8" slump, AZ Materials also adds 10 ounces of 69% water reducer and plasticizer.

Added  
6/29/21

## **WEIGHT OF ONE SQUARE (10'X10'=100' SF) OF WALL**

### **10 INCH ASYMMETRIC BLOCK**

1 Square = 25 wall block;  
25 blk/square x 57 lbs/blk = 1425 lbs/square  
.85 cy/square x 27 cf/cy = 22.95 cf/square  
22.95 cf/square x 145 lbs/cf = 3328 lbs/square  
1425 lbs/square + 3328 lbs/square = 4753 lbs/square

### **10 INCH 6"x6" CORE BLOCK**

1 Square = 25 wall block;  
25 blk/square x 47 lbs/blk = 1175 lbs/square  
1.31 cy/square x 27 cf/cy = 35.37 cf/square  
35.37 cf/square x 145 lbs/cf = 5129 lbs/square  
1175 lbs/square + 5129 lbs/square = 6304 lbs/square

### **8 INCH BLOCK**

1 Square = 25 wall block;  
25 blk/square x 43 lbs/blk = 1075 lbs/square  
.85 cy/square x 27 cf/cy = 22.95 cf/square  
22.95 cf/square x 145 lbs/cf = 3328 lbs/square  
1075 lbs/square + 3328 lbs/square = 4403 lbs/square

# EBS 6 INCH BLOCK SPECIFICATIONS

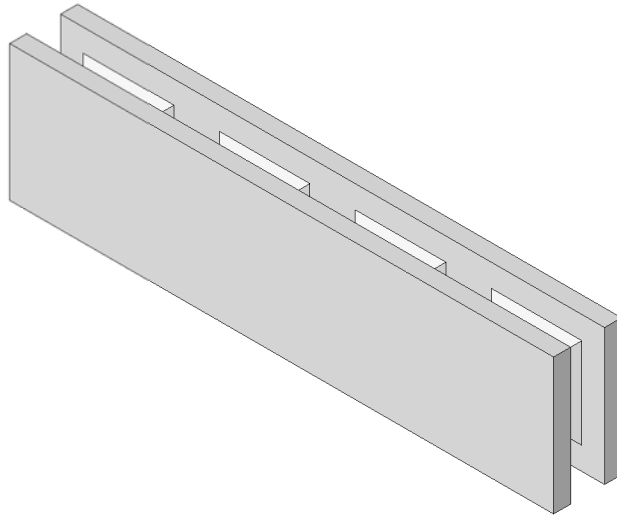

Manufacture of the 6" Block, Cap, and Corner has been discontinued until further notice for lack of demand.

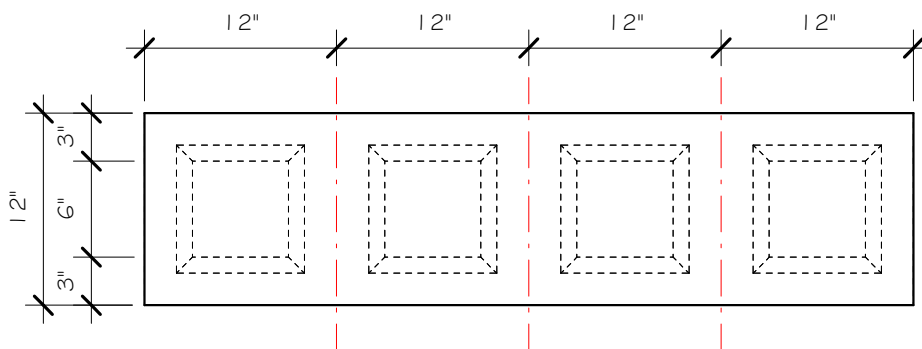
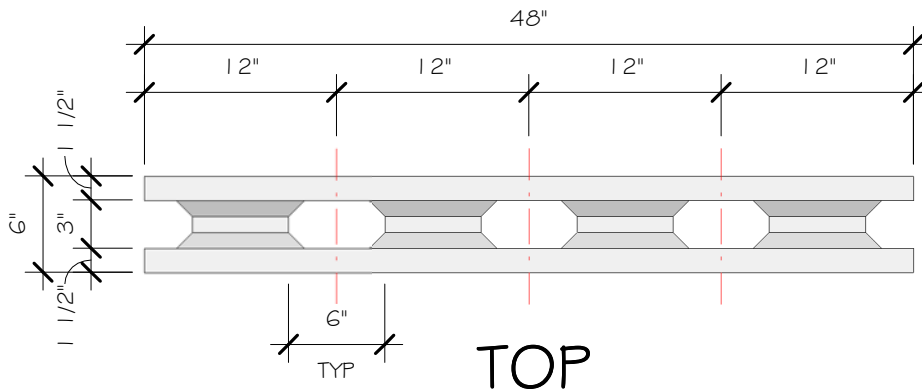

FRONT (WIREFRAME VIEW)

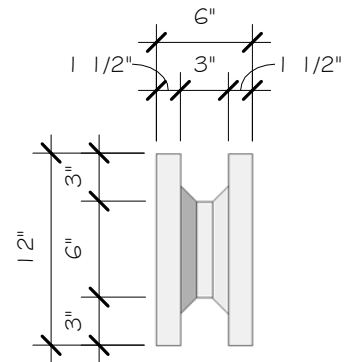

RIGHT

Figure 3.3

# EBS 8 INCH BLOCK SPECIFICATIONS

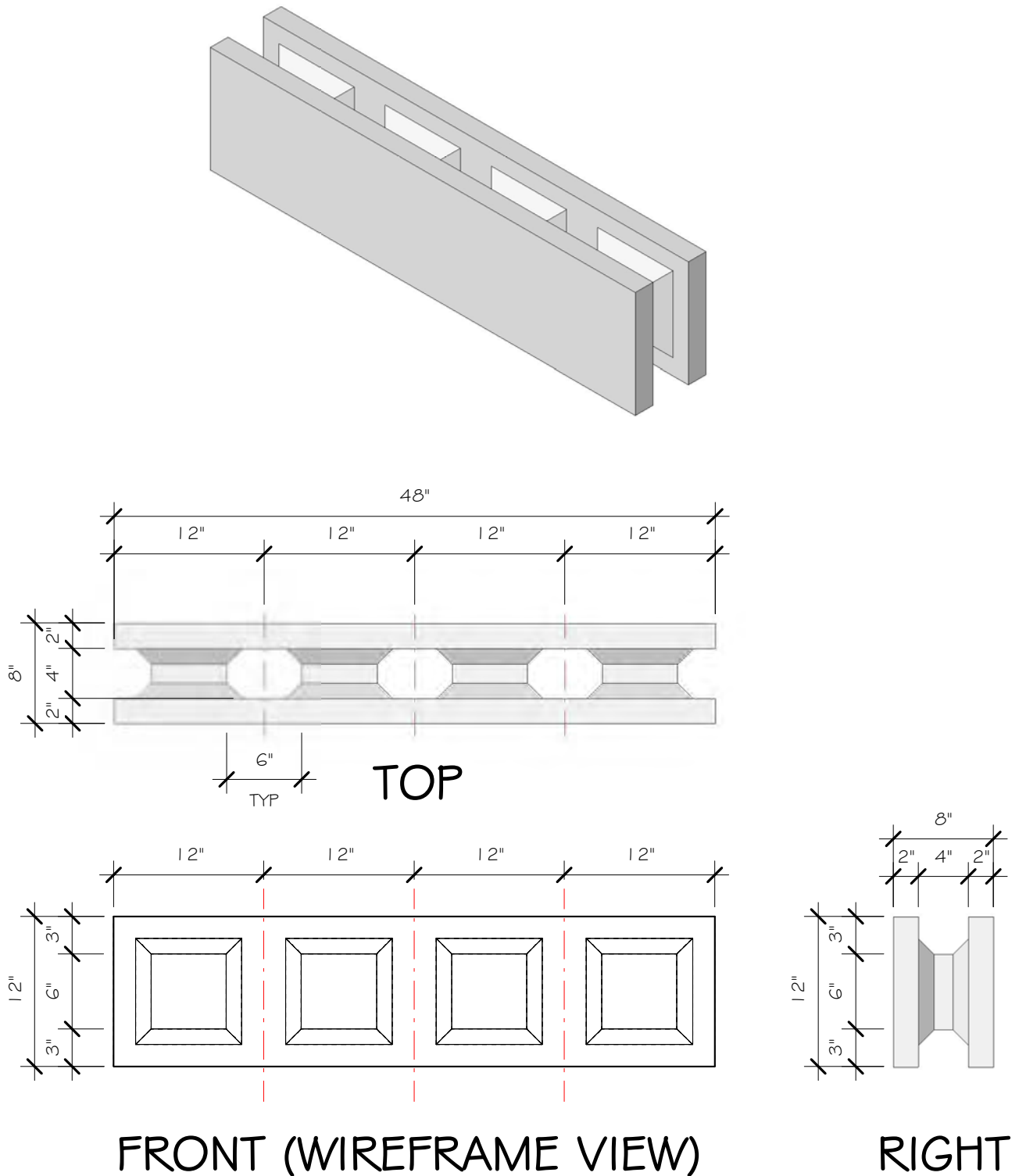
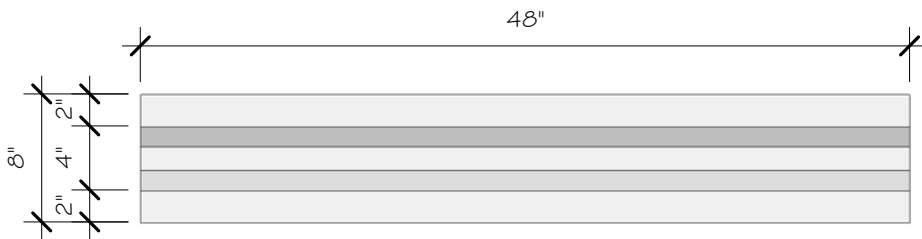
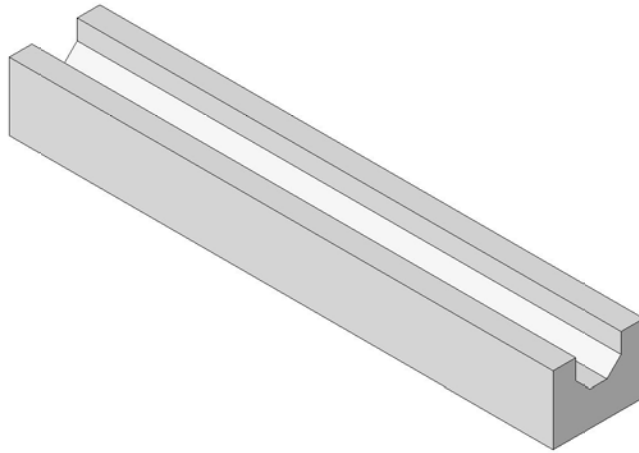
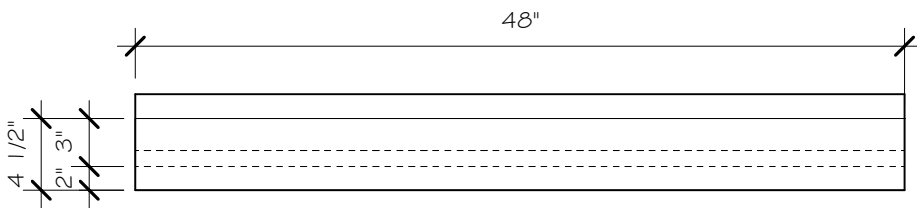

Figure 3.5

**EBS 8 INCH END BLOCK SPECIFICATIONS**



TOP



FRONT (WIREFRAME VIEW)

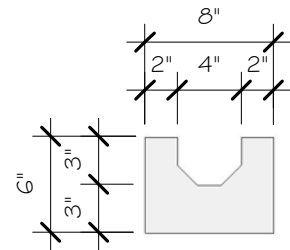

RIGHT

Figure 3.6

**EBS 8 INCH CORNER BLOCK SPECIFICATIONS**

---

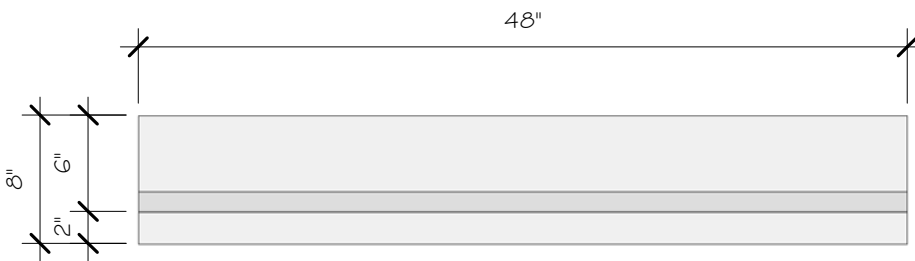
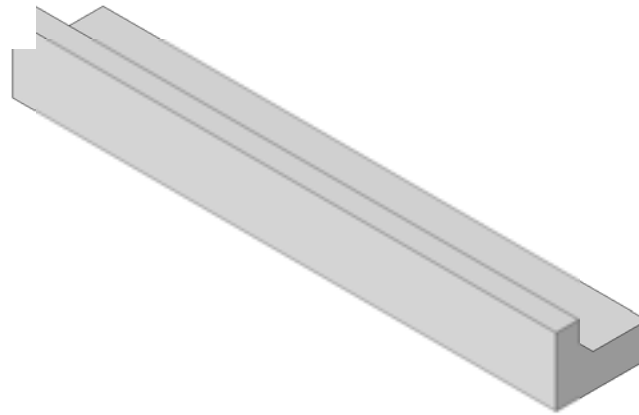

TOP

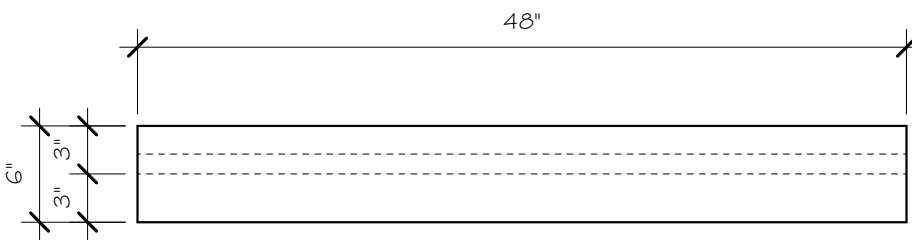

FRONT (WIREFRAME VIEW)

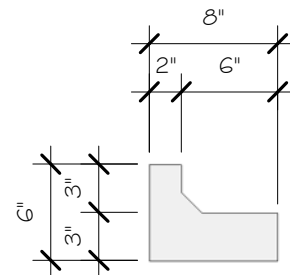

RIGHT

# EBS 10 INCH ASYMMETRIC BLOCK SPECIFICATIONS

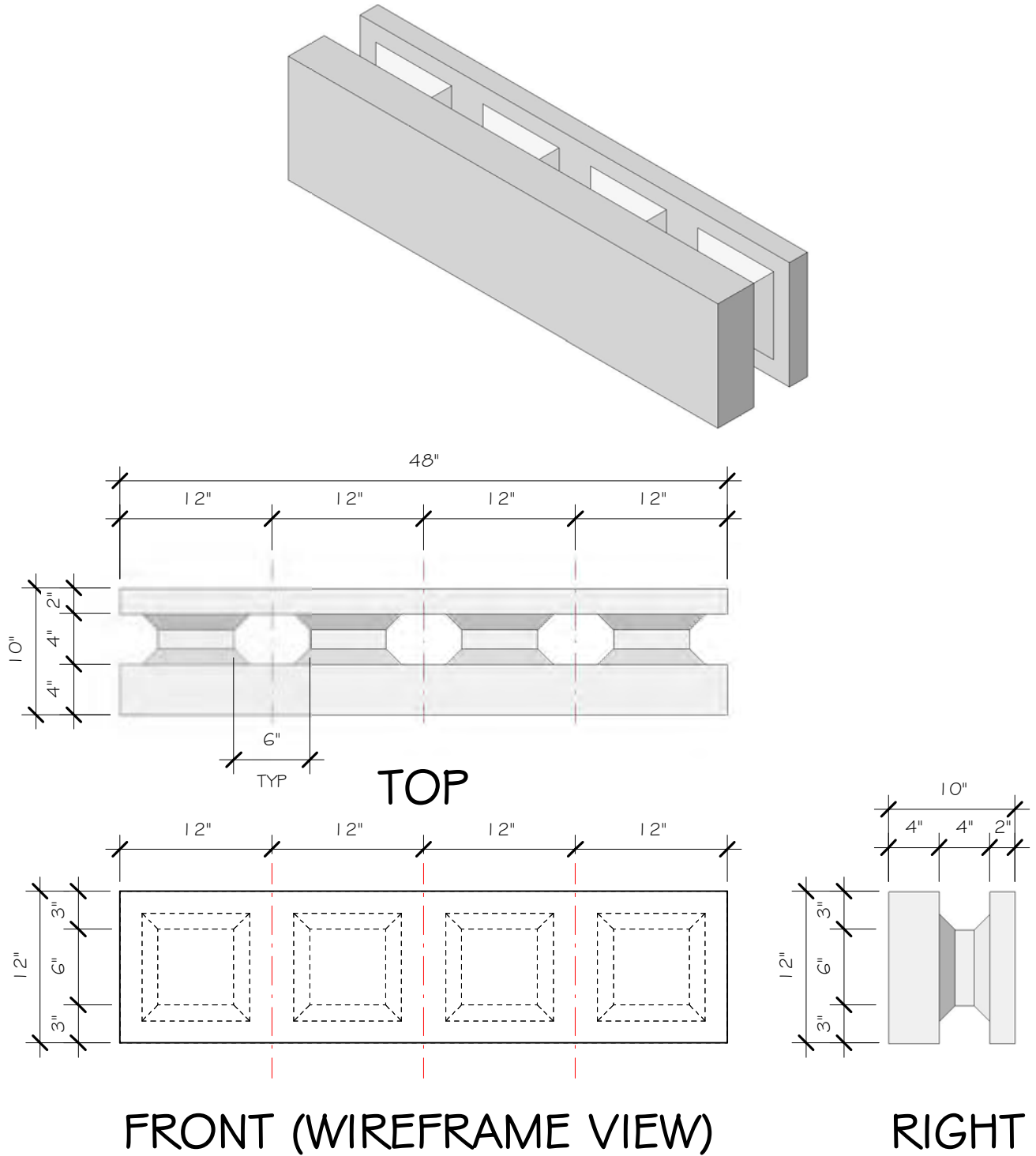

Figure 3.7

# EBS 10 INCH END BLOCK SPECIFICATIONS

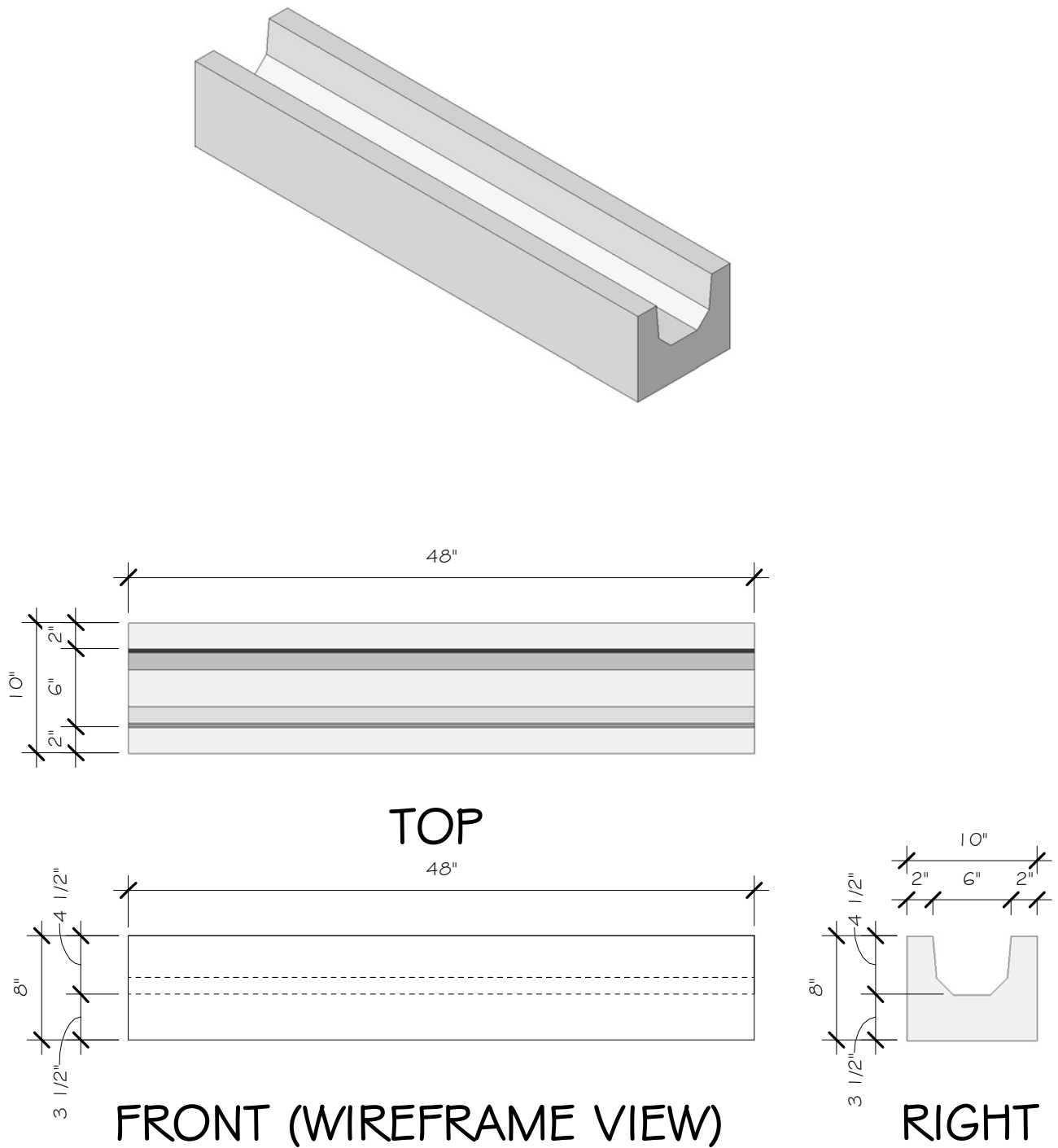
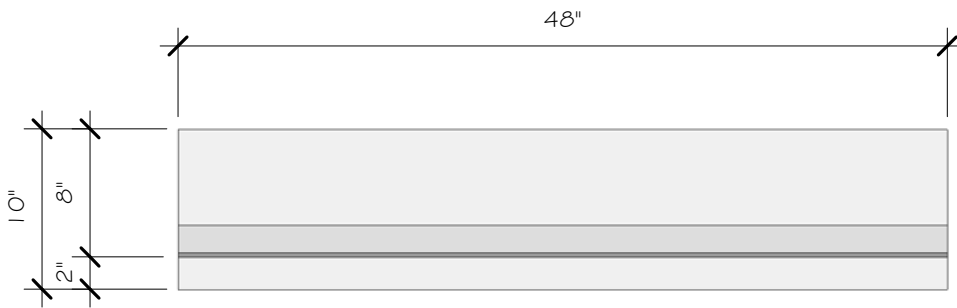
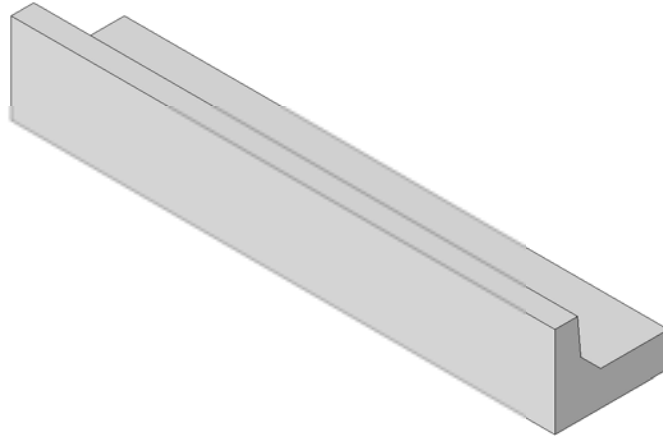

Figure 3.8

**EBS 10 INCH CORNER BLOCK SPECIFICATIONS**

---



TOP

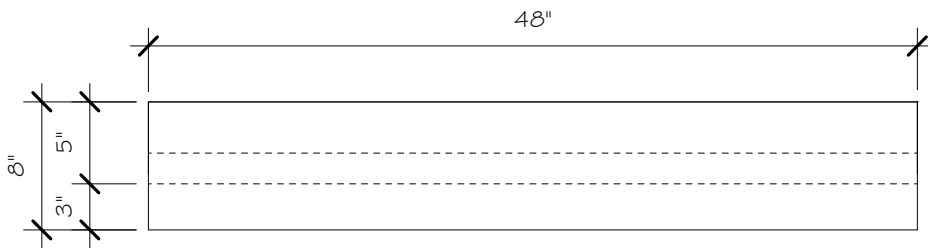

FRONT (WIREFRAME VIEW)

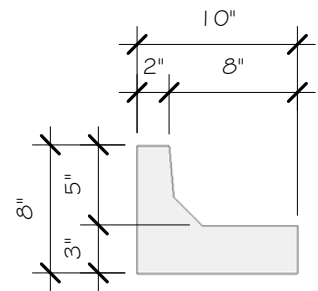

RIGHT

EBS 10 INCH - 6" X 6" CORE BLOCK  
SPECIFICATIONS

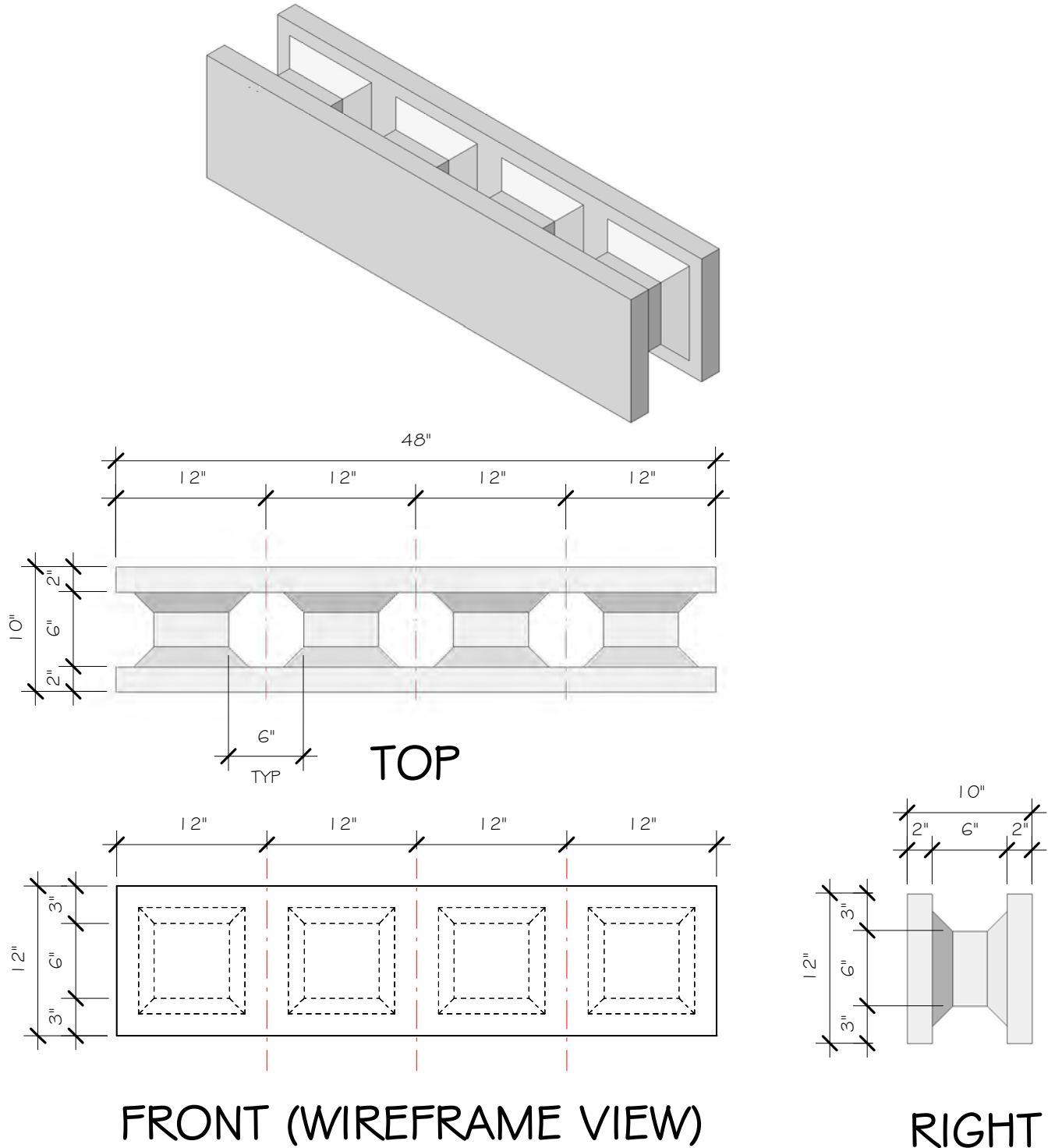

Figure 3.9



8960 W. Larkspur Drive, Ste. 105, Peoria, AZ 85381

Phone: 888.623.4223 (ICCF)

ThePerfectBlock.com

info@theprecblock.com

# THE PERFECT BLOCK

## MANUFACTURER PRICE LIST

NOVEMBER 1, 2023

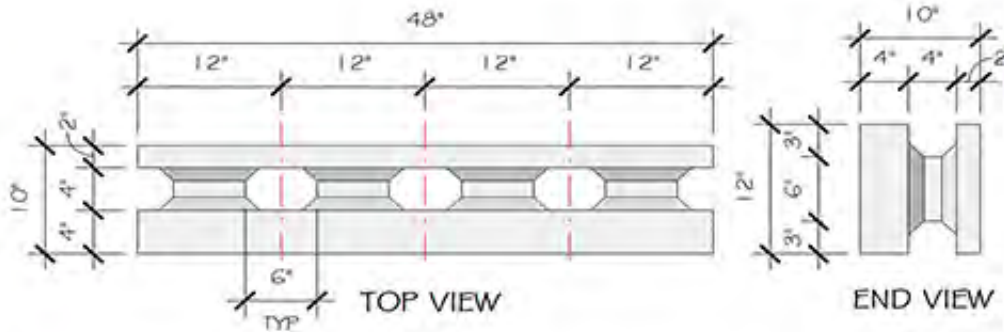

**10 INCH ASYMMETRIC  
4-FOOT BLOCK**

**\$30.00  
PER BLOCK**

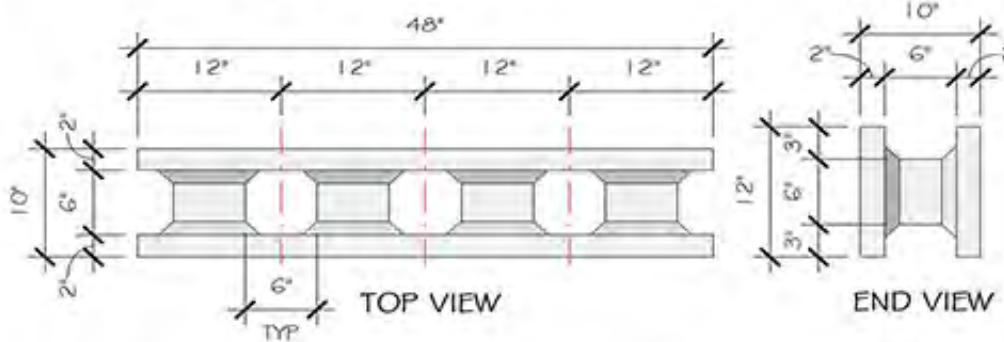

**10 INCH WITH  
6X6 INCH CORE  
4-FOOT BLOCK**

**\$27.00  
PER BLOCK**

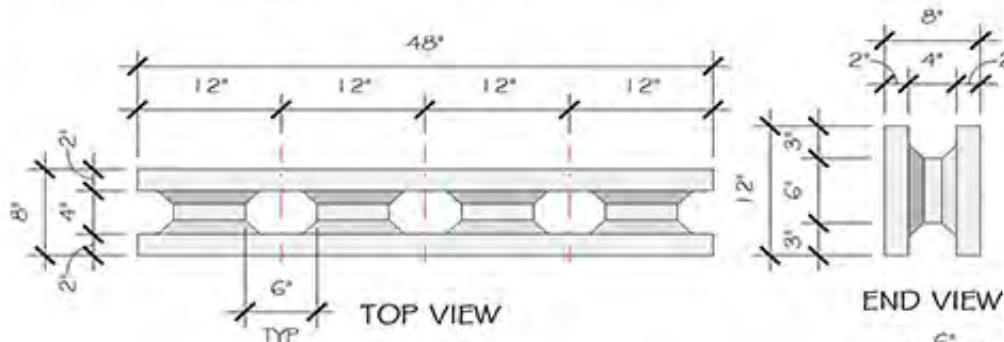

**8 INCH  
4-FOOT BLOCK**

**\$24.00  
PER BLOCK**

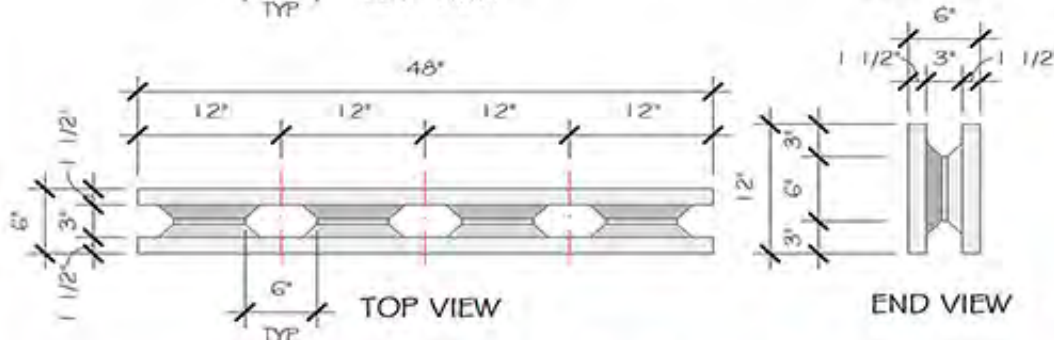

**6 INCH  
4-FOOT BLOCK**

**\$22.00  
PER BLOCK**

**Distributors & Volume Purchasers Welcome.  
Call Ryan or JK @ 888.623.4223 (ICCF)**

ALL RIGHTS RESERVED



8960 W. Larkspur Drive, Ste. 105, Peoria, AZ 85381

Phone: 888.623.4223 (ICCF)

ThePerfectBlock.com

info@thepreciseblock.com

# THE PERFECT BLOCK

## MANUFACTURER PRICE LIST

### FIRE TESTED, FIRE SAFE

### DISASTER SAFE

### BUILDING PRODUCTS

# 2023

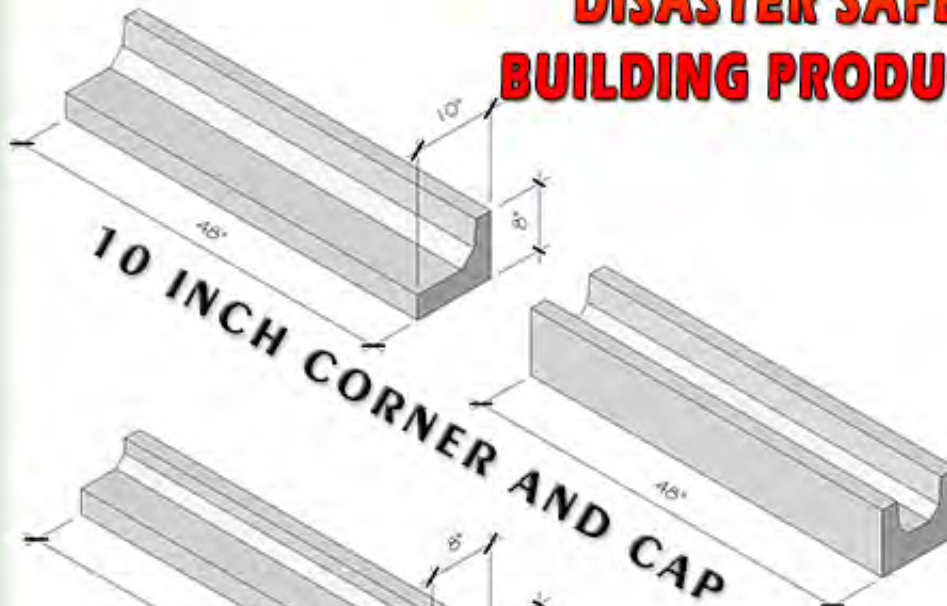

10 INCH CORNER AND CAP



**\$25.00**

PER BLOCK

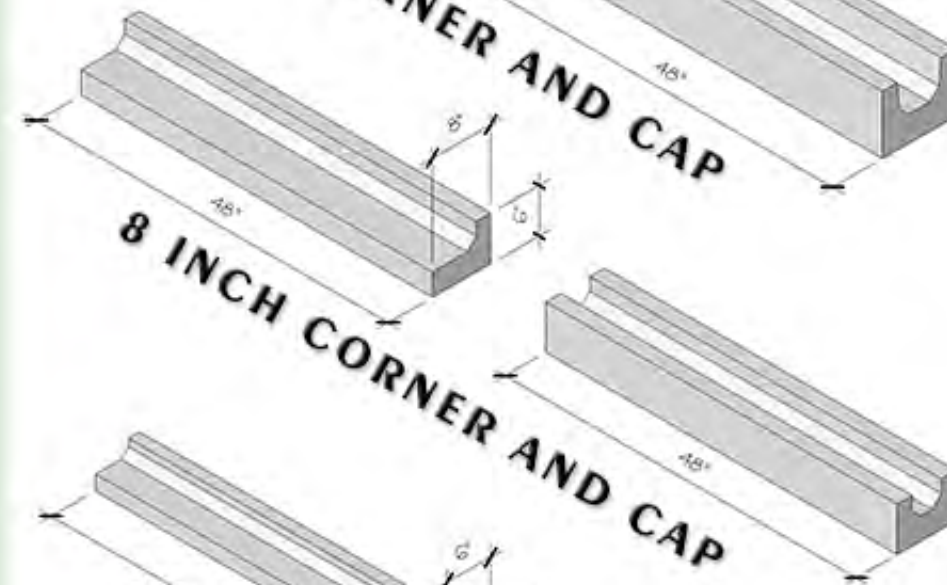

8 INCH CORNER AND CAP

**\$23.00**

PER BLOCK

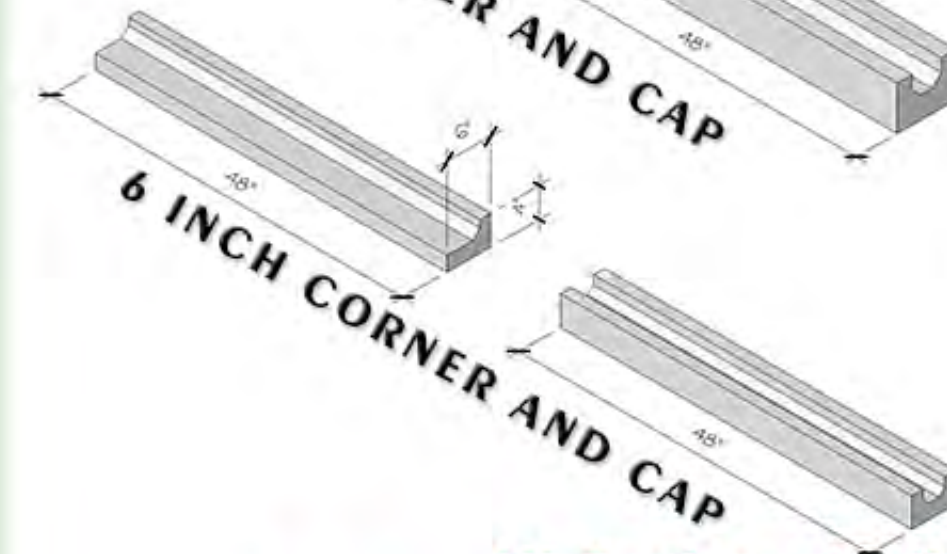

6 INCH CORNER AND CAP

**\$21.00**

PER BLOCK

**All Products Available.**

**Call RYAN OR JK @ 888.623.4223 (ICCF)**

ALL RIGHTS RESERVED

## PLANNING

### Recommended Tools and Supplies

Eco Building Systems Corp. building elements may be installed with conventional construction tools normally used in the installation of common building materials.

#### Some Typical Tools used when building with The Perfect Block™:

Keyhole Saw	Ladders	Hole Saw Bit for drill
Hand Saw	Gloves	-2", 5", 6" dia
Large Speed Square	Dust Mask	Mason's String
Electric Chain Saw	Safety glasses	Tape Measure: 25', 100'
Circular Saw with guide	Floor Scraper	Stakes
Reciprocating Saw	Shop Vacuum	Rasp
Electric Drill	Scaffolding on Wheels	Spray Foam Adhesive Gun
Framing Hammer	Rebar Cutter / Bender	Saw Guide (use w/ chainsaw)
6' Level	Chalk Line	Large Trash Can
Saw Horses	Broom	Dust pan

#### Supplies:

Eco Building Systems Corp. Elements	2X Lumber	Anchor bolts w/ washers & nuts
Rebar	15/32" OSB Plywood	16d Nails
Spray Foam Adhesive	1/4" or 3/8" threaded rod, washers & nuts	3" Wood Screws
Wood or Plastic Shims		

#### Guidance and information for use of some of the recommended tools:

Keyhole Saw - Probably the most useful tool you will have in your tool belt while building ICCF walls. It's used for small cuts, fitting blocks, shimming and plumbing blocks, scribing accurate marks and other uses too numerous to mention.



Handsaw - Simplest tool to cut ICCF. A handsaw and a large speed square is one of the most precise methods to cut ICCF at any angle. Even a dull crosscut handsaw will cut the ICCF easily and quick but it is not the fastest way.



Large Speed Square - A large triangular tool to easily make cuts at 90 degrees and all angles in between.



Electric Chain Saw - An electric chain saw with a saw guide is the fastest way to cut ICCF blocks. Use an electric chain saw (not a gas chain saw) for ease of use and lower cost. The saw's life may be cut short from cement dust and an electric saw can be replaced at a lower cost. Do not oil the bar chain. Oil and dust may jam a saw. Even a chainsaw with a dull chain will cut ICCF easily. We consider this an essential tool for installing electrical boxes, receptacles, Romex, and conduit.



## PLANNING

### Recommended Tools and Supplies (Cont.)

Guidance and information for use of some of the recommended tools (Cont.):

Circular saw and rip guide - with a wood cutting blade to cut accurate long cuts ("ripper cuts") in ICCF and to cut wood for braces and bucking. The saw blade can be old and dull, it will still cut ICCF easily. The saw equipped with a metal cutting blade can be used to cut rebar in lieu of a dedicated rebar cutter.



Reciprocating Saw (optional) - Can be used to cut ICCF block or rebar (not as precise as a chain saw or handsaw or as rapid cutting rebar). An alternate use: With the blade removed and a 2x4 stud to protect the block, the saw can be used as external vibrator on ICCF walls during grouting if external vibration is deemed necessary. Increasing grout slump is preferred.



Hole Saw - The size will depend on the needs for each project. Typical sizes are 2", 3", 4", 5", to 6". To be used along with the Drill to cut holes for ledger anchor bolts, pipes, etc. A keyhole saw can be used to cut holes for ledgers or grout pumping, round or square, albeit not as clean as a hole saw bit, but less expensive.



Level - A standard 4-foot level can be used, but a 6-foot level would be the best all around level for leveling block courses and checking for straight, plumb walls and wall faces.



Mason's String - Mason's String is great to use to check the straightness of long walls during wall construction.



Ladders - Standard 6' or 8' step ladder along with extension ladders. Assorted ladders may be needed during construction.

Scaffolding - Scaffolding on lockable wheels is essential to constructing and grouting walls safely and efficiently. Have at least two or three tiers of scaffolding for 10' -12' walls and several platforms.



Rebar Bender/Cutter - Used to bend and cut rebar for corner bars and foundation and stem wall steel. This is not mandatory but is easier and faster than cutting and bending by hand. Add a 3-4' length of 1-11/2" diameter steel pipe to make tight double angles in rebar.

Rasp - This tool made from expanded metal can be fabricated or purchased. It is used to shape and smooth ICCF surfaces and edges. The size is approximately 6" by 8". A rasp can be fashioned by placing stucco lath in a drywall hand sander or on a 2X4 block.

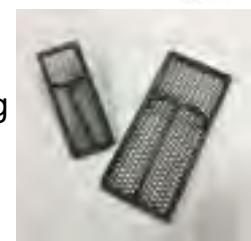

## PLANNING

### Recommended Tools and Supplies (Cont.)

Guidance and information for use of some of the recommended tools (Cont.):

**Spray Foam Adhesive Gun** - This is used with the polyurethane foam adhesive to tack ICCF elements during construction prior to grouting. The gun attaches to foam adhesive foam canisters by means of a threaded coupler. Use commercial quality foam adhesive not foam dispensed with a straw.



**Spray Foam Adhesive and Cleaner** - Used with adhesive gun to tack ICCF elements and several other uses during construction. The cleaner is acetone and very little is ever needed except to restore a clogged gun.



Dow ENER Foam is the recommended foam adhesive to use.

See  
alternative  
foam  
adhesives  
on  
following  
page



[https://www.amazon.com/Enerfoam-30oz-Sealant-Polyurethane-Insulation/dp/B091MLX4G2/ref=sr\\_1\\_1?crd=1Q4WAHQB2003Q&keywords=enerfoam+30oz&qid=1667581457&qu=eyJxc2MiOilxLjQ3liwicXNhIjoiM C4wMCIsInFzcCI6IjAuMDAifQ%3D%3D&srefix=ener+foam%2Caps%2C756&sr=8-1](https://www.amazon.com/Enerfoam-30oz-Sealant-Polyurethane-Insulation/dp/B091MLX4G2/ref=sr_1_1?crd=1Q4WAHQB2003Q&keywords=enerfoam+30oz&qid=1667581457&qu=eyJxc2MiOilxLjQ3liwicXNhIjoiM C4wMCIsInFzcCI6IjAuMDAifQ%3D%3D&srefix=ener+foam%2Caps%2C756&sr=8-1)

[https://www.amazon.com/GREAT-STUFF-Cleaner-12oz-Applicators/dp/B0BJXQH8BN/ref=sr\\_1\\_1\\_sspa?crd=161NQJUDE7MPS&keywords=spray+foam+cleaner&qid=1667585745&qu=eyJxc2MiOil1Ljc2liwicXNhIjoiNS42OCIsInFzcCI6IjUuMjMifQ%3D%3D&srefix=spray+foam+cleaner%2Caps%2C216&sr=8-1-spons&psc=1](https://www.amazon.com/GREAT-STUFF-Cleaner-12oz-Applicators/dp/B0BJXQH8BN/ref=sr_1_1_sspa?crd=161NQJUDE7MPS&keywords=spray+foam+cleaner&qid=1667585745&qu=eyJxc2MiOil1Ljc2liwicXNhIjoiNS42OCIsInFzcCI6IjUuMjMifQ%3D%3D&srefix=spray+foam+cleaner%2Caps%2C216&sr=8-1-spons&psc=1)

**Staples (Reusable)** - Primarily used to hold elements together that need additional mechanical hold strength such as corner elements at corners during grout pours. They can be purchased from EBS or fabricated locally or fashioned on-site with strips of OSB and framing nails. See details in this manual for fabricating these for yourself.



**Wood or Plastic Shims (Reusable)** - Used for shimming ICCF blocks during wall erection to plumb or level the elements prior to tacking in place with spray foam adhesive.



**Floor scraper** - Excellent tool to quickly scrape excess foam glue and shims protruding from wall seams in preparation for finishing. Easily scrapes concrete splashes on finished concrete after grouting to prevent marring surfaces with hardened concrete.



## PLANNING

### Recommended Tools and Supplies (Cont.)

#### **Alternative to ENER Foam Adhesive**

**Spray Foam Adhesive** - Used with adhesive gun to tack ICCF elements and several other uses during construction.



[https://www.amazon.com/GREAT-Construction-Adhesive-Gun-Applied-Polyurethane/dp/B071P2JG68/ref=sr\\_1\\_8?keywords=BOSS%C2%AE+337+CONSTRUCTION+ADHESIVE+FOAM+GUN+GRADE&qid=1667581277&qu=eyJxc2MiOilwLjxliwicXNhIjoiMC4wMCIsInFzcCI6IjAuMDAifQ%3D%3D&sr=8-8](https://www.amazon.com/GREAT-Construction-Adhesive-Gun-Applied-Polyurethane/dp/B071P2JG68/ref=sr_1_8?keywords=BOSS%C2%AE+337+CONSTRUCTION+ADHESIVE+FOAM+GUN+GRADE&qid=1667581277&qu=eyJxc2MiOilwLjxliwicXNhIjoiMC4wMCIsInFzcCI6IjAuMDAifQ%3D%3D&sr=8-8)



#### **TYTAN Professional 60 Second Bond Foam Adhesive 12 PK.**

Brand: TYTAN

★★★★★ 1 (2009)

[https://www.amazon.com/TYTAN-Professional-Second-Bond-Adhesive/dp/B081QQFSG3/ref=sr\\_1\\_1?crid=1WXXIYD6SR12Q&keywords=tytan+adhesive&qid=1667586624&qu=eyJxc2MiOilxLjU4IiwicXNhIjoiMC4wMCIsInFzcCI6IjAuMDAifQ%3D%3D&srefix=tytan+adhesive%2Caps%2C156&sr=8-1](https://www.amazon.com/TYTAN-Professional-Second-Bond-Adhesive/dp/B081QQFSG3/ref=sr_1_1?crid=1WXXIYD6SR12Q&keywords=tytan+adhesive&qid=1667586624&qu=eyJxc2MiOilxLjU4IiwicXNhIjoiMC4wMCIsInFzcCI6IjAuMDAifQ%3D%3D&srefix=tytan+adhesive%2Caps%2C156&sr=8-1)

## PLANNING

### Estimating Materials Needed for Your Project if You have a Plan

To determine an estimate of the building materials required for the construction of the basic TPB walls for your project if you have a plan, the following "short cut" calculations can give you a quick estimate for the number of block and costs (using current price lists on pages 3.10 and 3.11.) needed for your project.

**This will help give you an idea for the required number and cost of the block for your project:**

For more detailed estimates of block, concrete, and rebar, please use the guidance from the calculation example in the Technical Construction Manual, Planning section, in the following pages, pages 4.3 to 4.10.

#### **To get a rough calculation of blocks needed:**

To calculate # of block = total linear feet of wall X height of wall = total wall sf - (square feet of windows and doors) = total wall sf w/o openings, add 2% sf for waste, Total sf + (Total wall sf x .02 =?) = total wall sf for block calculation  
divide by 4 sf = total # of block,

Choose the core size and thickness of block you want.

# of blocks x price per block = block cost

Count corners X height of walls, divide by 4 = # of corner blocks.

# of corner blocks x price per corner block = corner block cost

plus tax and shipping.

Precise takeoffs require quite a bit of time to complete. I encourage you to use the guidance in the build manual I have attached to help you determine your wall block, concrete and rebar costs based on your unique design. When you are ready to order block, knowing which block you want and the costs, then with a detailed plan, (you need floor plan dimensions, top plate heights, elevations, and the choice of block we make), EBS can do a takeoff for your order from the plan that will be precisely what you need.

It is essential, if you are building your own house and acting as your own General Contractor, that you know all these estimated costs and how to determine them so you can make informed decisions throughout the construction of your house. And from personal calculations, you will be well informed with your decisions.

## PLANNING

### Estimating Materials Needed for Your Project

To determine an estimate of the building materials required for the construction of the basic TPB walls for your project, use the following example as a guide.

Example Building: This example is based on building a 10' tall ICCF block wall using TPB 10" Asymmetric ICCF on a poured concrete stem wall and slab foundation (or monolithic footing and slab).

60' x 55' rectangular building with integral garage/3300 sq ft footprint

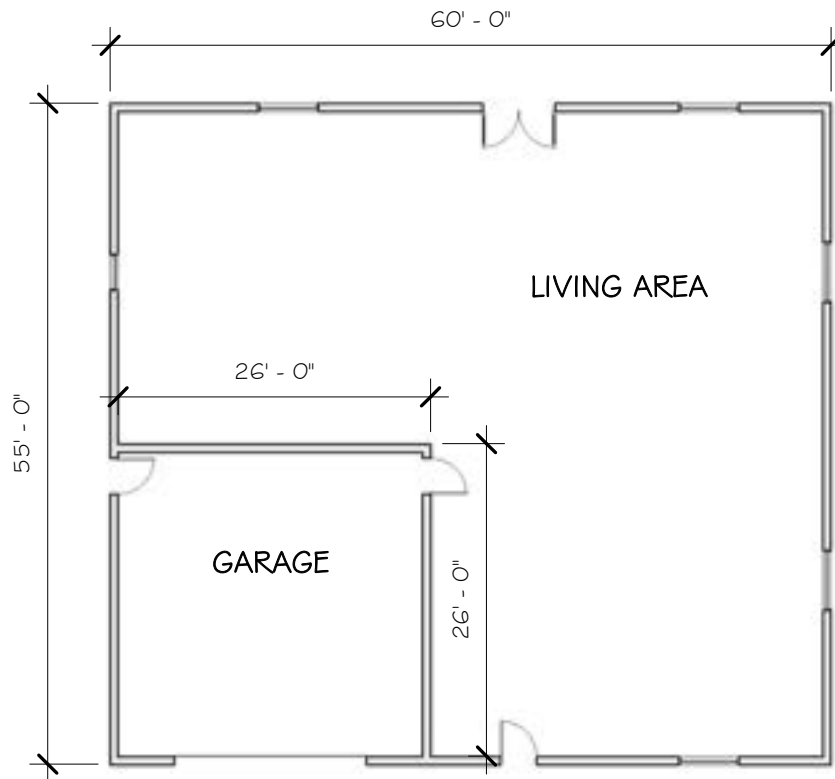

Figure 4.1

Example Description:

TPB 10" Asymmetric ICCF block at a 10' wall height

60' x 55' rectangular footprint floor plan

ICCF perimeter				
wall linear ft	=	60' + 60' + 55' + 55'	=	230'
Total perimeter				
wall area	=	10' Wall Height x 230'	=	2300 sq ft of wall area

## PLANNING

### Estimating Materials Needed for Your Project (Cont.)

#### Example Description (Cont.):

26' x 26' garage with ICCF separation walls

Garage wall linear ft	=	26' + 26'	=	52'
Total interior garage wall area	=	10' Wall Ht x 52'	=	520 sq ft of wall area
 Total Wall Area, Perimeter Wall + Garage Wall	=	 2300 + 520	=	 2820 sq ft of wall area

#### Openings:

Doors:	3 - 3' x 7' Entry Doors, 3 x (3' x 7')	=	3 x 21	=	63 sq ft
	1 - 6' x 7' Patio Door, 1 x (6' x 7')	=	1 x 42	=	42 sq ft
	1 - 16' x 8' Garage Door, 1 x (16' x 8')	=	1 x 128	=	128 sq ft
	Total door opening voided wall area	=	63 + 42 + 128	=	-233 sq ft
Windows:	5 - 5' x 4' Windows, 5 x (5' x 4')	=	5 x 20	=	100 sq ft
	1 - 3' x 3' Window, 1 x (3' x 3')	=	1 x 9	=	9 sq ft
	Total window opening voided wall area	=	100 + 9	=	-109 sq ft
	Total Opening Doors + Windows Voided Wall Area	=	233 + 109	=	-342 sq ft

## PLANNING

### Estimating Materials Needed for Your Project (Cont.)

#### Estimating "The Perfect Block<sup>TM</sup>" Required for Your Project

Using the example project building, we will illustrate a sample method to estimate the following building materials to complete the walls of the example project:

**Number of TPB 10" Asymmetric ICCF wall blocks**

**Number of TPB 10" ICCF corner blocks**

**Number of 20' Rebar rods**

**Cubic Yards of Concrete Grout**

**Note: This estimating example does not estimate material requirements for construction of your foundation and/or stem wall design.**

To determine the number of wall block required for your project, from your design plans, calculate the "total wall area" of your perimeter TPB walls plus any interior TPB walls (of the same thickness and core) such as garage separation walls. Then subtract the total wall area voided by openings (doors and windows), divide that sum by 4 (square feet of wall area per ICCF block) to calculate the number of blocks required. Now with the actual wall area take 2% (suggested overage) of wall area added for contingencies and divide that area by 4. Add those calculated block numbers. The total will be the estimated ICCF block required for your project.

Example Calculation:

Total Building Wall Area - Total Opening Voided Wall Area = Total Actual Wall Area

2820 sq ft (from Page 4.4) - 342 sq ft (Opening Wall Area)

= 2478 sq ft

2478 sq ft divided by 4 (sq ft of each ICCF block)

= 619.5 = 620 ICCF wall blocks

Rule of Thumb (ROT) = Add 2% to your calculated square footage to account for contingencies

2% of 2478 sq ft = .02 x 2478 = 49.56 sq ft , rounding up to 50 sq ft divided by 4 = 12.5, Add 13 ICCF block

## PLANNING

### Estimating Materials Needed for Your Project (Cont.)

#### Estimating ICCF Block Required for Your Project (Cont.)

$$\begin{aligned} &= 13 \text{ ICCF wall blocks for contingencies} \\ \mathbf{620 + 13} &= \mathbf{633 \text{ ICF wall blocks}} \end{aligned}$$

To calculate the EBS corner blocks required for the example project, count the corners and multiply by 2.5 for the number of 4' long end blocks needed to finish the 10' tall corners.

$$\begin{aligned} 5 \text{ corners} \times 2.5 &= 12.5 \text{ ICCF corner blocks} \\ &\text{rounded up to 13 corner block:} \\ &= \mathbf{13 \text{ ICCF corner blocks}} \end{aligned}$$

#### Estimating Rebar Required for Your Project

Use the previous floor plan example for estimating rebar for this project

**Note: This example does not estimate rebar for your foundation and/or stem wall design.**

**Note: Rebar comes in 20', 40', and 60' rods. Check with your steel supplier for the best price and length of rebar rods they can provide.**

To determine the number of rebar rods (assuming 20' bars are used) required for your building's walls, first determine the design requirements for rebar in your design plan.

Assumptions:

- This example's design plan requires only #4 Rebar (1/2" diameter bars)
- The design requires both horizontal and vertical rebar to be placed at 24" on center
- The horizontal rebar lap splice is 24"
- Corner lap splice bars will be 5' long to accommodate a 90-degree bend and two lap splices of 24" each.

## PLANNING

### Estimating Materials Needed for Your Project (Cont.)

#### Estimating Rebar Required for Your Project (Cont.)

To determine the number of rebar rods (assuming 20' bars) required for your project, from your design plans, calculate the "total linear feet" of your perimeter ICCF walls plus any interior ICCF walls such as garage separation walls, etc.

60' x 55' rectangular footprint floor plan ICCF perimeter wall linear ft	=	60' + 60' + 55' + 55' =	230'
26' x 26' garage with ICCF separation walls garage wall linear ft	=	2 x 26'	= 52'
Total Wall Linear Feet	=	230' + 52'	= 282'

For illustration purposes, disregard any rebar subtraction for door or window openings, use this additional rebar for your overage for contingencies

Let's calculate vertical rebar for your walls at 24" on center:

For a 10' wall height, each vertical rebar will be 10'

282' divided by 2 (24" on center)	=	141 10' long rebar rods
141 x 10'	=	total 1410' of rebar for your verticals
1410' divided by 20	=	70.5
	=	<b>71 - 20' rebar rods for verticals</b>

Add 2 - 10' rods for each opening for code required vertical placement:

(5 doors + 6 windows = 11 openings)	x	2
	=	22
22 x 10'	=	220'
220' divided by 20'	=	<b>11 - 20' rebar rods for opening sides</b>

## PLANNING

### Estimating Materials Needed for Your Project (Cont.)

#### Estimating Rebar Required for Your Project (Cont.)

Now calculate for horizontal rebar at 24" on center:

For a 10' wall height and horizontal rebar at 24" on center there will be 5 tiers of horizontal rebar.

$$282' \text{ Total Wall Linear Feet} \times 5 \text{ tiers} = 1410'$$

Assuming rebar in 20' rods

$$1410' \text{ divided by } 20' = 70.5 - 20' \text{ rebar rods}$$

$$= \mathbf{71 - 20' rebar rods for horizontal rebar}$$

Since horizontal lap splice will consume 2' of each horizontal rebar, we'll need to add rebar to account for this lap splice

$$71 \times 2' = 142' ; 142' \text{ divided by } 20' = 7.1 - 20' \text{ rebar rods}$$

$$= \mathbf{8 - 20' rebar rods for lap splice}$$

Now calculate the number of 5' corner bars required for the example building:

$$\text{Count the corners and the two wall intersections: } 5 + 2 = 7$$

The number of corner bars required for each corner and intersection will be the same as the number of tiers for a 10' wall height = 5.

$$5 \text{ tiers} \times 7 \text{ corners and intersections} = 35$$

$$35 \times 5' = 175', 175' \text{ divided by } 20' = 8.75$$

$$= \mathbf{9 - 20' rebar rods for corners and intersections}$$

## PLANNING

### Estimating Materials Needed for Your Project (Cont.)

Now add all rebar required for the example building:

Vertical Rebar	71 for 24" O.C. wall 11 for opening sides
Horizontal Rebar	71 for 5 tiers 8 for 24" lap splice in 6 tiers
Corner Rebar	9 for 5' bars at corners and intersections
<b>Total Project Rebar</b>	<b>170 - 20' rebar rods</b>

### Estimating Concrete Grout Required for Your Project

There are three methods to determine the cubic yards of grout (concrete) to fill your ICCF walls.

**Note: Concrete consumption for TPB 8" and 10" Asymmetric is identical for each block. (4" x 6" core)**

The first method is to use the following equations:

**Total wall square footage ÷ 100 sf (represents a 10'x10' section of wall, commonly called a "square")**

**= The total number of squares**

**Total number of squares X cubic yard consumption for specific core**

**= Estimated Cubic Yards of Grout**

Referencing Technical Data & Specifications, Page 3.1, for concrete consumption per "square" for the three different size cores we manufacture:

#### Wall Block

<b>6" TPB</b>	<b>3" x 6" core consumes .62 cubic yards/square</b>
<b>8" &amp; 10" Asymmetric</b>	<b>4" x 6" core consumes .85 cubic yards/square</b>
<b>10" 6x6 Core</b>	<b>6" x 6" core consumes 1.31 cubic yards/square</b>

Using our building example:

From page 4.5, the total wall square footage is 2820 sf - 342 sf for openings = 2478 sf

**2478 sf/100 = 24.78 squares; 24.78 x .85 cubic yards/square = 21.1 cubic yards**

## PLANNING

### Estimating Materials Needed for Your Project (Cont.)

#### Estimating Concrete Grout Required for Your Project (Cont.)

The second method is to use the following equation:

$$\begin{aligned} \text{Total wall square footage} \div \text{Cubic Yard Estimate Factor (F)} \\ = \text{Estimated Cubic Yards of Grout} \\ \text{Total wall square footage} / F = \text{Estimated cu yds} \end{aligned}$$

The Cubic Yard Estimate Factor (F) for 8" and 10" Asymmetric block is 118

<u>Wall Block</u>	<u>Cubic Yard Estimate Factor (F)</u>
6" TPB	161
8" & 10" Asymmetric	117
10" 6x6 Core	76

Using our building example:

From page 4.5, the total wall square footage is 2820 sf - 342 sf for openings = 2478 sf

Plugging the numbers into the equation:

$$2478 \text{ sf} / 117 = 21.2 \text{ cubic yards}$$

**Estimated Cubic Yards of Grout**

The third method:

From page 4.5 the project block estimate

<b>Project block estimate</b>	<b>=</b>	<b>620 TPB blocks</b> <b>Note: The 2% overage of 13 TPB blocks is not included</b>
	<b>=</b>	<b>620 blocks for grout calculation</b>
<b>620 wall blocks x .034 cu yd/block</b>	<b>=</b>	<b>21.1 cu yds concrete</b>

## PLANNING

### Estimating Materials Needed for Your Project (Cont.)

#### Estimating Concrete Grout Required for Your Project (Cont.)

**Builder's Tip:** Finding yourself short on concrete or grout day because of a miscalculation can be a costly mistake. Double and triple check your math and bump up your contingency percentage if you aren't confident that you will have enough. But don't waste concrete left over. Plan ahead to have pads, doorsteps, walkways, etc. framed ahead of time to use every bit of leftover concrete. Ensure all concrete forming and finishing tools are readily available.

Add approximately 3% for concrete grout contingencies,

$$3\% \text{ of } 21.1 \text{ cubic yards} = .03 \times 21.1 = .63 \text{ cu yds}$$

$$21.1 \text{ cu yds} + .63 \text{ cu yds} = 21.73 \text{ cu yds}$$

$$\text{Total Wall Concrete Grout} = \mathbf{22 \text{ cu yds}}$$

#### Final Estimate of Required Building Materials for Example Project

**633 TPB 10" Asymmetric ICCF wall blocks**

**13 TPB 10" ICCF corner blocks**

**170 20' rebar rods**

**22 cubic yards of concrete**

## PLANNING

### Foundation Design Choices

There are several different methods to create a foundation for an Eco Building Systems Corp. ICCF block building. The following CAD details illustrate some of choices for the builder to use for his or her structure.

There are several additional details for ICCF wall construction available on our website: [ThePerfectBlock.com](http://ThePerfectBlock.com), and if you can't find a detail you need, please contact us at 1-888-623-4223 (ICCF) and we may have what you need on file.

#### CAD Details

8" Block Strip Ftg & ICCF Stem Wall & Slab.....	Fig. 5.1
Modified ICCF Stem Wall & Integrated Slab.....	Fig. 5.2
ICCF Wall W/ Concrete Stem Wall, Spread Ftg & Slab.....	Fig. 5.3
8" ICCF Wall W/ CMU Stem Wall & Slab.....	Fig. 5.4
ICCF Wall W/ Monolithic Slab & Ftg.....	Fig. 5.5
ICCF Basement Wall W/ Monolithic Ftg.....	Fig. 5.6
ICCF Wall W/ Garage Stem Wall Ftg.....	Fig. 5.7

The vertical rebar placement in the foundation for the required wall rebar overlap is the same for each method and will be described in the next section.

Figure 5.1

## PLANNING

### Foundation Design Choices (Cont.)

UPDATED 3/17/19

**NOTE TO IRONWORKERS:** VERT DOWELS ARE SPREAD ONLY TO ILLUSTRATE ALTERNATING DIRECTION. KEEP VERT DOWELS IN LINE/IN PLANE.

8" ICCF BLOCK WALL

1/2" GYP BD OR PLASTER COATING

FOUNDATION VERTICAL REINF SHALL EXTEND A MIN OF 24" ABOVE TOP OF FOOTING FOR MIN LAP SPLICE WITH VERTICAL WALL REINF

**ENERGY EFFICIENCY NOTE:** IN REGIONS OF CLIMATE EXTREMES, USING ICCF BLOCKS FOR STEM WALLS PROVIDES THE FLOOR SLAB A THERMAL BREAK FROM OUTSIDE WEATHER CONDITIONS THUS REDUCING THE IMPACT OF OUTSIDE AIR TEMPARTURES ON THE INSIDE OF THE BUILDING. THIS BUILDING METHOD ISOLATES AND INSULATES THE FLOOR SLAB FROM THE EXTERIOR AND IS MORE ENERGY EFFICIENT THAN OTHER CONVENTIONAL METHODS.

4" CONCRETE SLAB

6 MIL PLASTIC VAPOR BARRIER (OPTIONAL)

4" COMPACTED GRANULAR FILL

COMPACTED FILL

UNDISTURBED EARTH

2-#4 REBAR CONTINUOUS

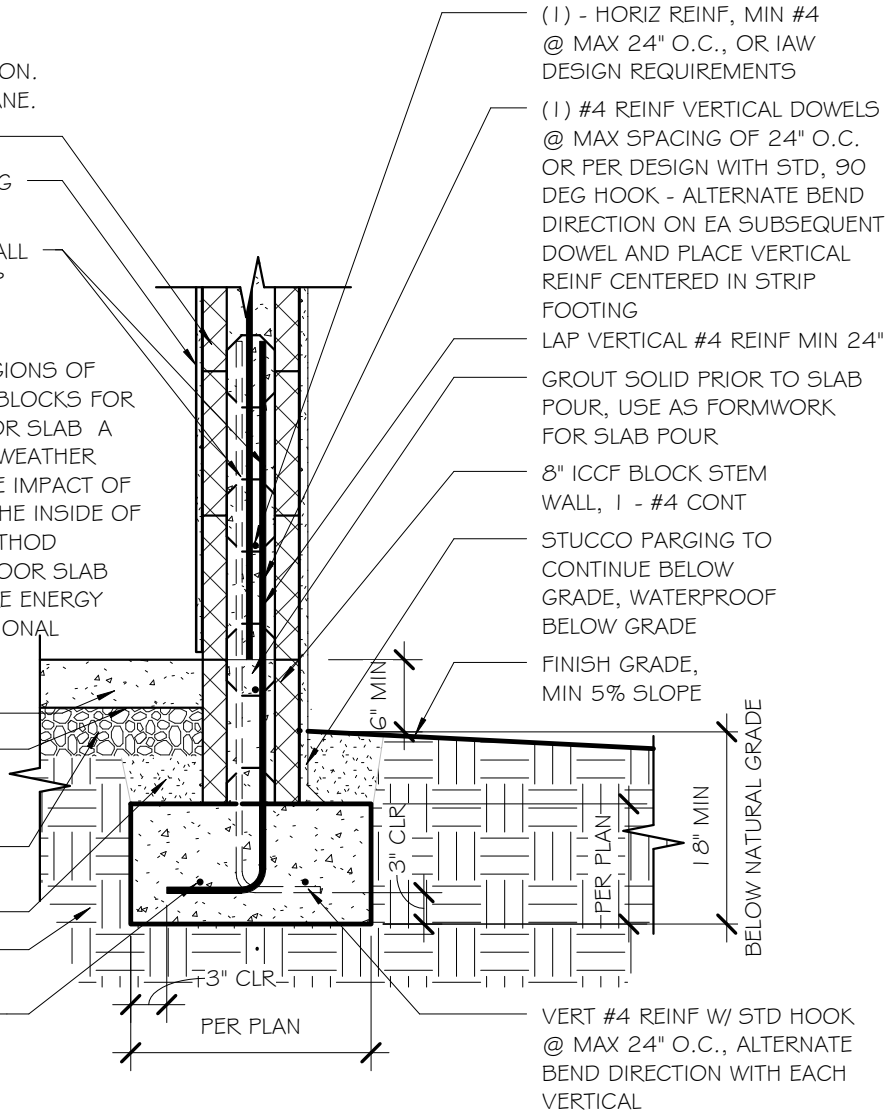

(1) - HORIZ REINF, MIN #4 @ MAX 24" O.C., OR IAW DESIGN REQUIREMENTS

(1) #4 REINF VERTICAL DOWELS @ MAX SPACING OF 24" O.C. OR PER DESIGN WITH STD, 90 DEG HOOK - ALTERNATE BEND DIRECTION ON EA SUBSEQUENT DOWEL AND PLACE VERTICAL REINF CENTERED IN STRIP FOOTING

LAP VERTICAL #4 REINF MIN 24"

GROUT SOLID PRIOR TO SLAB POUR, USE AS FORMWORK FOR SLAB POUR

8" ICCF BLOCK STEM WALL, 1 - #4 CONT

STUCCO PARGING TO CONTINUE BELOW GRADE, WATERPROOF BELOW GRADE

FINISH GRADE, MIN 5% SLOPE

BELOW NATURAL GRADE

VERT #4 REINF W/ STD HOOK @ MAX 24" O.C., ALTERNATE BEND DIRECTION WITH EACH VERTICAL

## 8" BLOCK STRIP FTG & ICCF STEM WALL & SLAB

SCALE: 3/4" = 1'-0"

Figure 5.1

## PLANNING

### Foundation Design Choices (Cont.)

UPDATED 12/16/20

**ENERGY EFFICIENCY NOTE:** IN REGIONS OF CLIMATE EXTREMES, USING ICCF BLOCKS FOR STEM WALLS PROVIDES THE FLOOR SLAB A THERMAL BREAK FROM OUTSIDE WEATHER CONDITIONS THUS REDUCING THE EFFECT OF OUTSIDE AIR TEMPARTURES ON THE INSIDE OF THE BUILDING. THIS BUILDING METHOD ISOLATES AND INSULATES THE FLOOR SLAB FROM THE EXTERIOR AND IS MORE ENERGY EFFICIENT THAN OTHER CONVENTIONAL METHODS.

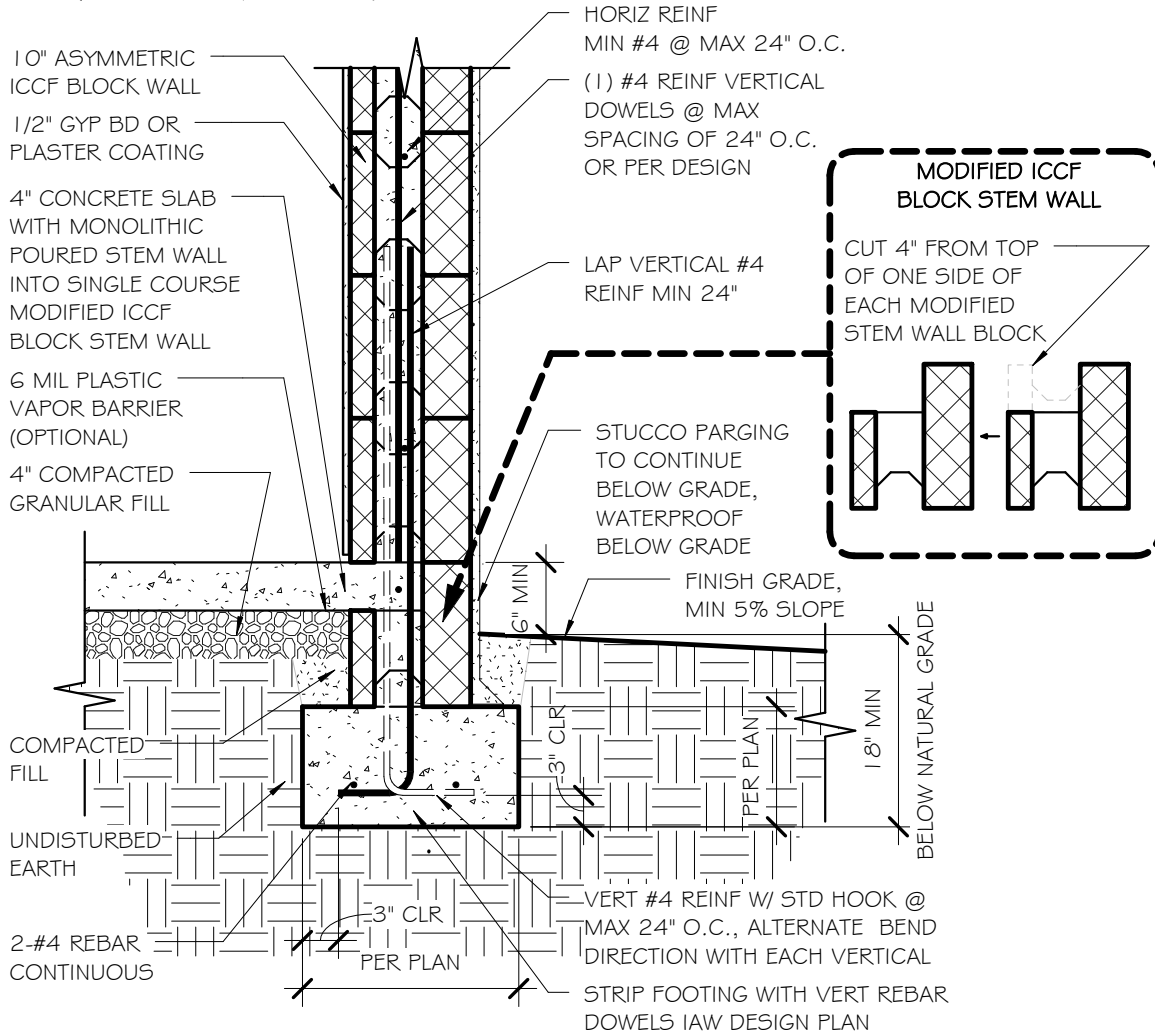

**NOTE TO IRONWORKERS:** VERT DOWELS ARE SPREAD ONLY TO ILLUSTRATE ALTERNATING DIRECTION. KEEP VERT DOWELS IN LINE/IN PLANE.

## MODIFIED ICCF STEM WALL & INTGD SLAB

SCALE: 3/4" = 1'-0"

Figure 5.2

## PLANNING

### Foundation Design Choices (Cont.)

**NOTE TO IRONWORKERS:** VERT DOWELS ARE SPREAD ONLY TO ILLUSTRATE ALTERNATING DIRECTION. KEEP VERT DOWELS IN LINE/IN PLANE.

UPDATED 3/17/19

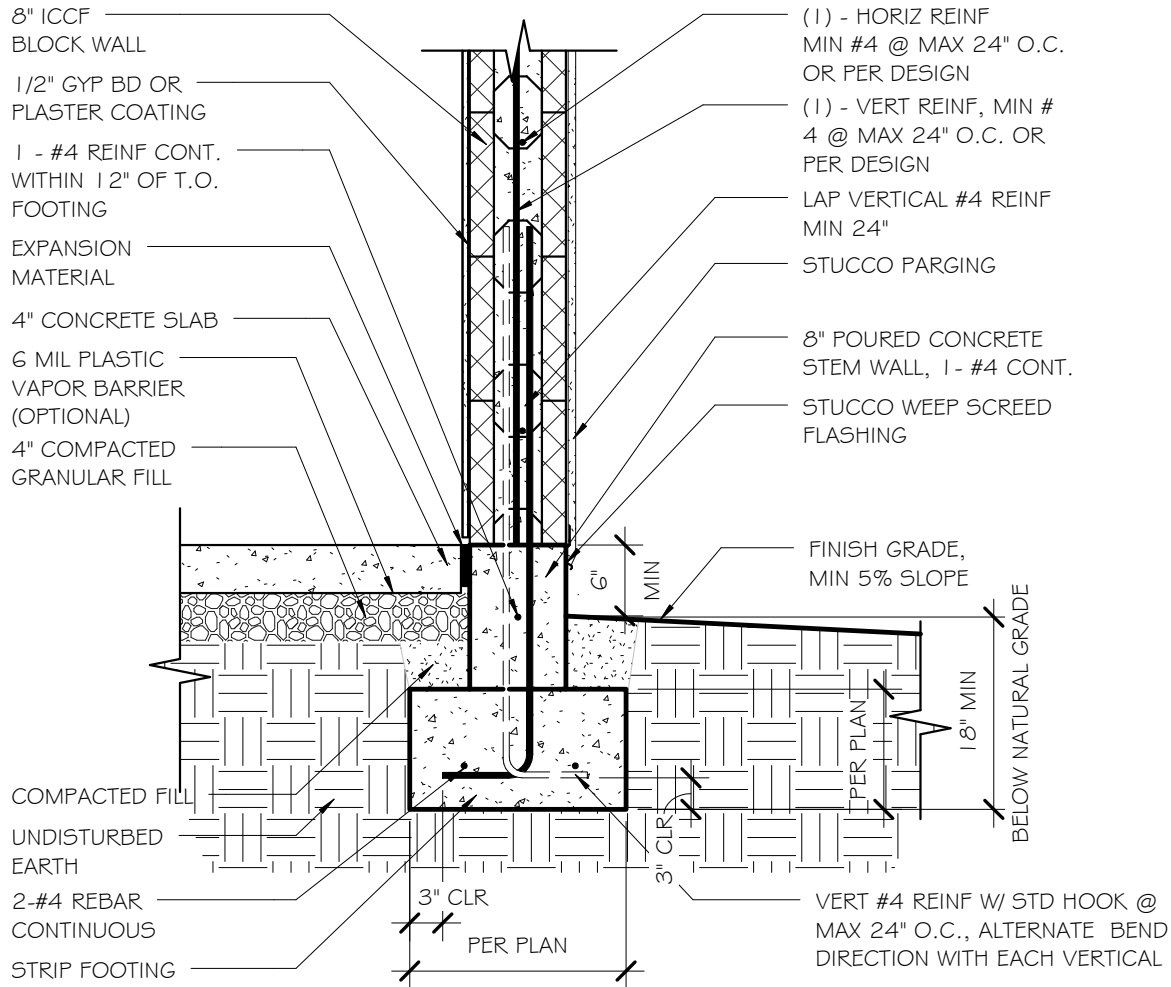

## ICCF WALL W/ CONC STEM WALL & SLAB

SCALE: 3/4" = 1'-0"

Figure 5.3

## PLANNING

### Foundation Design Choices (Cont.)

**NOTE TO IRONWORKERS:** VERT DOWELS ARE SPREAD ONLY TO ILLUSTRATE ALTERNATING DIRECTION. KEEP VERT DOWELS IN LINE/IN PLANE.

UPDATED 3/17/19

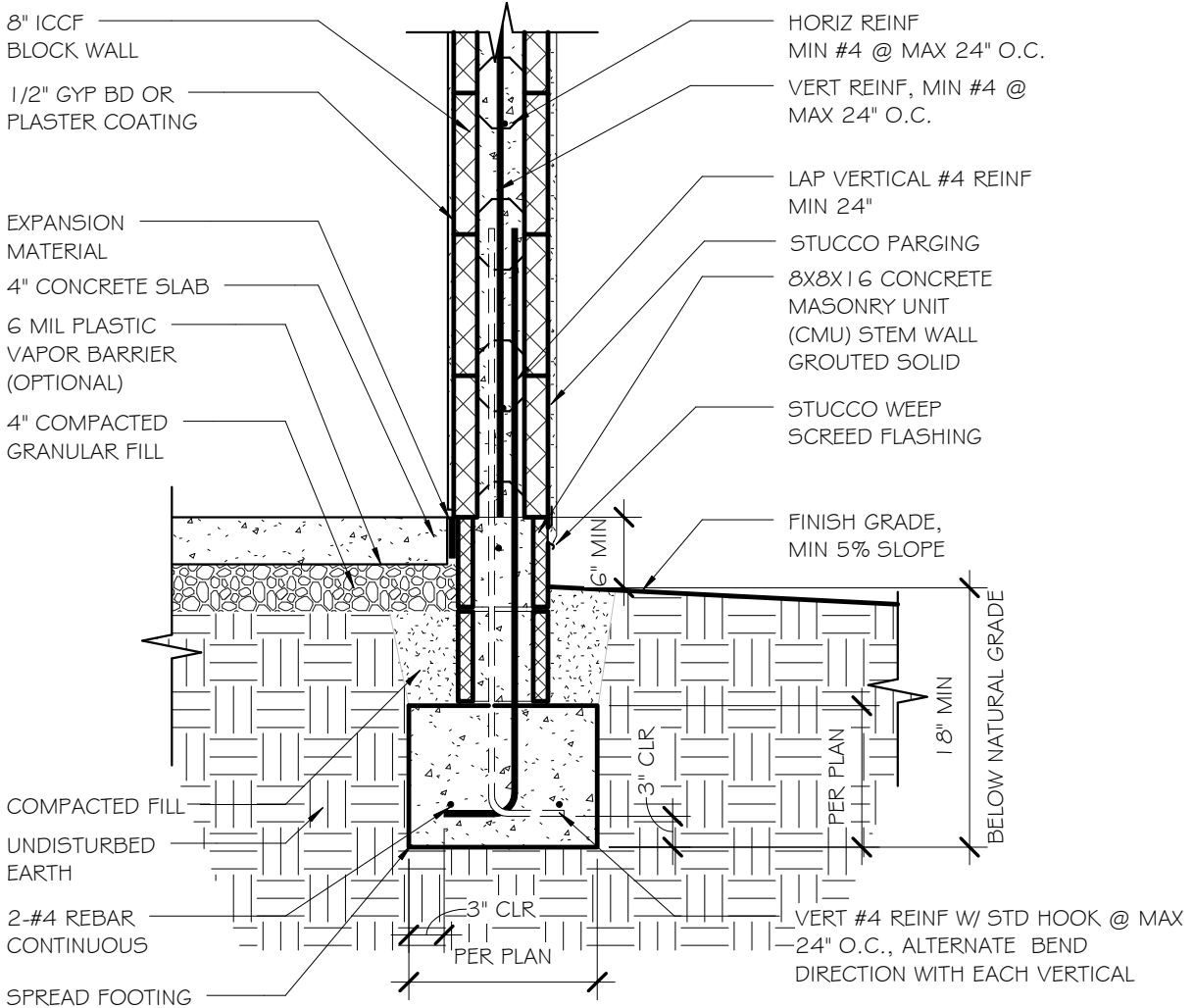

## 8" ICCF WALL W/ CMU STEM WALL & SLAB

SCALE: 3/4" = 1'-0"

Figure 5.4

## PLANNING

### Foundation Design Choices (Cont.)

UPDATED 3/17/19

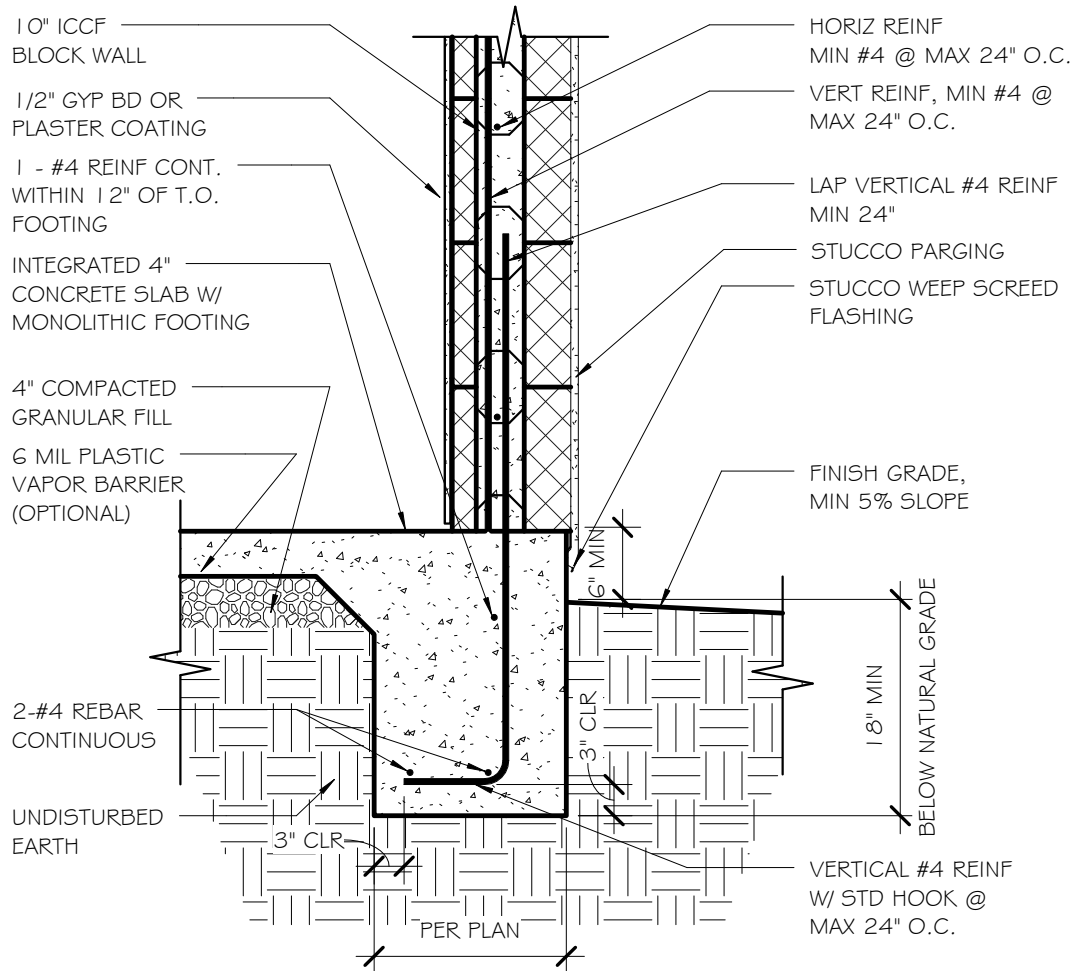

## ICCF WALL W/ MONOLITHIC SLAB & FTG

SCALE: 3/4" = 1'-0"

Figure 5.5

## PLANNING

### Foundation Design Choices (Cont.)

UPDATED 3/17/19

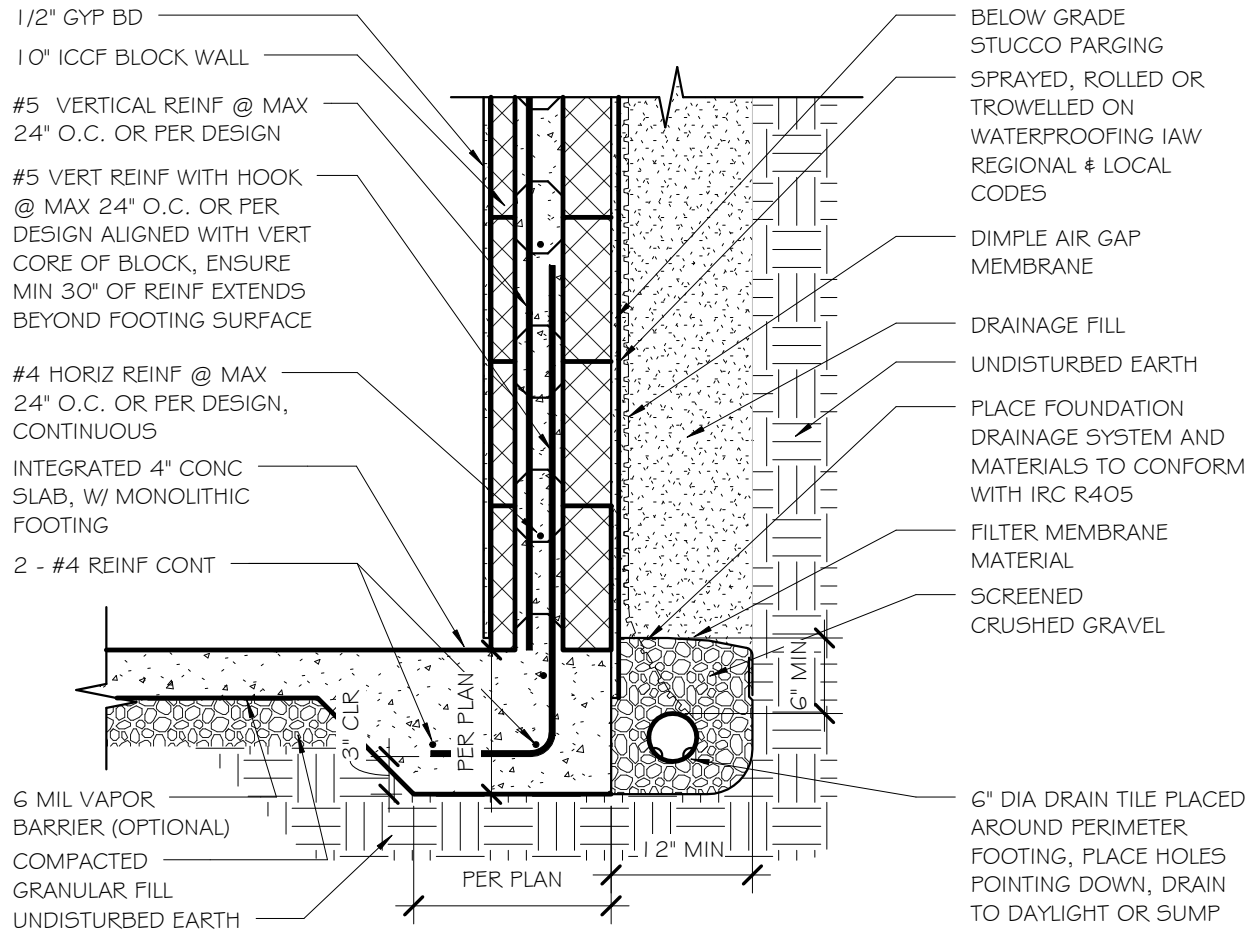

## ICCF BASEMENT WALL W/ MONOLITHIC FTG

SCALE: 3/4" = 1'-0"

Figure 5.6

## PLANNING

### Foundation Design Choices (Cont.)

UPDATED 9/14/19

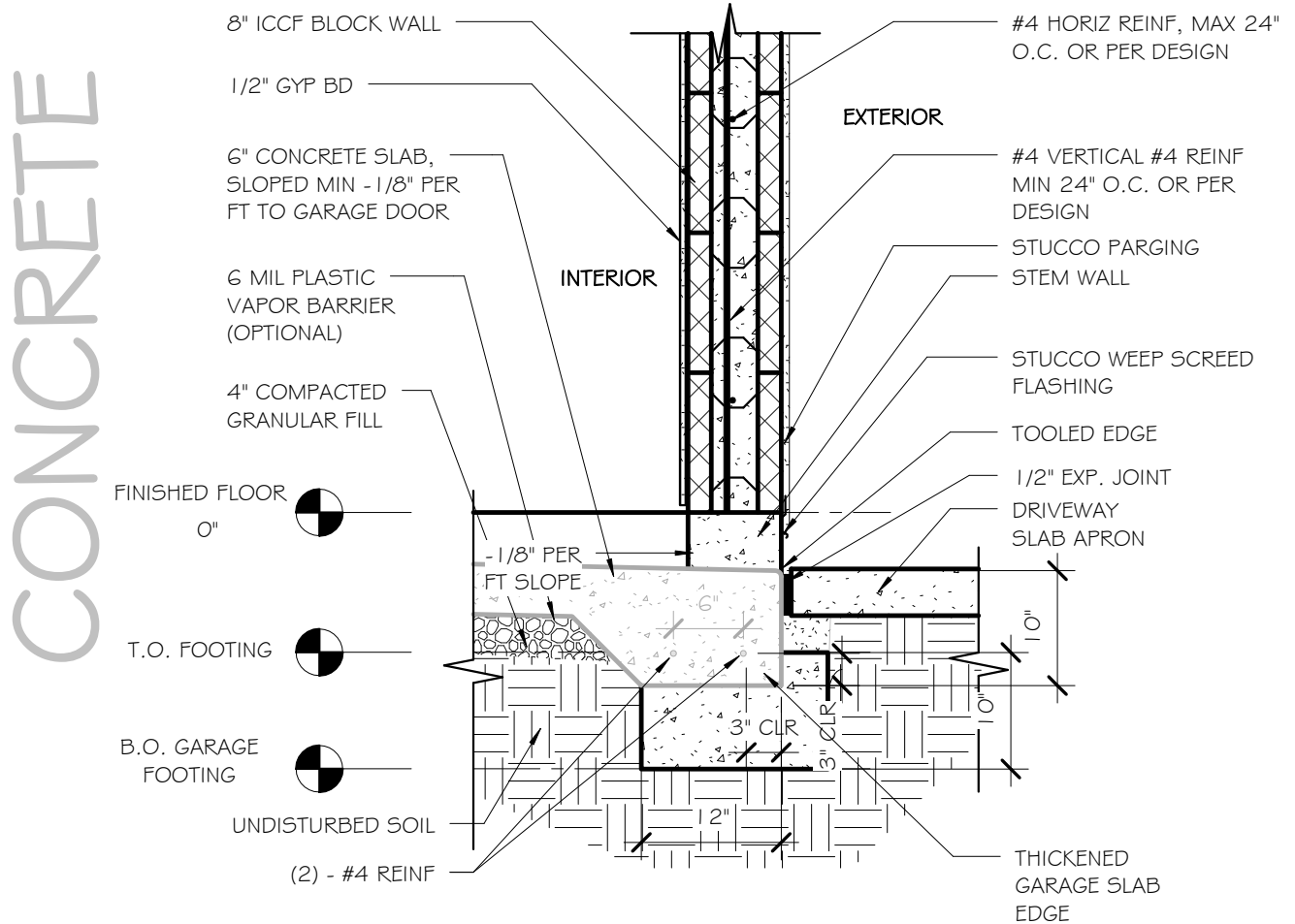

## ICCF WALL W/ GARAGE STEM WALL FTG

SCALE: 3/4" = 1'-0"

Figure 5.7

## **BLOCK DELIVERY AND UNLOADING**

### **Block Delivery**

#### **UNLOADING TECHNIQUES AND TIPS AND REQUIREMENTS**

Shipping the EBS ICCF building elements to your jobsite is a simple and essential part of starting and completing your project. We at EBS, ship our ICCF block almost exclusively by 53' dry van (semi-tractor trailer). And we are happy to support those that want to arrange for their own shipping or pickup block themselves at our factory.

Why ship in a dry van (semi-trailer)? We load our block on 48"x48" pallets. A typical pallet of block will be approximately 7'-4" tall and will weigh between 1600 to 2200 lbs. each, averaging about 1800 lbs. The size and weight of the pallets of block allow us to load a 53' van with up to 24 pallets of block, loaded side-by-side, distributing the load weight within the trailer to allow for a maximum weight load below the truck carrier's load limits, maximizing the amount block per shipment. We ship all over the nation and Canada, and shipping by dry van eliminates any threat of weather affecting the weight of the load. In addition, damage during shipping is virtually non-existent when shipping by dry van.

#### **Purchasers of the EBS blocks Responsibilities:**

The contractor or owner/builder preparing to order and receive block from us must first evaluate their jobsite access and terrain for any issues that might complicate the offload of block from a dry van.

Safety during offloading must be your primary concern. Parking the semi-truck and van on a flat, open area with no obstacles as close to the jobsite would be ideal and then you can place your block directly on your slab from the truck. But if you can't do this safely, then you may have to unload on a nearby road or area, empty the truck and send the truck on its way. Most carriers allow for a two-hour offload time. Beyond that, you may be charged for additional time delay. With the block unloaded, transport the load in the best way possible to your jobsite slab.

Evaluating your jobsite for unloading concerns will determine the unloading equipment you must have at unloading time.

**An all-terrain reach truck with an 1800 lb. pallet of ICCF block at a jobsite where the semi-truck needed to be parked on the road, some distance away from the slab.**



## BLOCK DELIVERY AND UNLOADING

### Block Delivery (Cont.)

### UNLOADING TECHNIQUES AND TIPS AND REQUIREMENTS (Cont.)

Whether you own, rent, or borrow the equipment, you will need the following:

**You MUST have a forklift or all terrain reach truck capable of lifting and handling 2200 lbs. or more.** (When we unload block when building in our design/build company, our preference is a reach truck. A reach truck adds much more flexibility to our unloading than a forklift and the rental cost difference is insignificant.)

**You MUST have a pallet jack capable of lifting and handling 2200 lbs. or more.** (We like two. One in the truck, and one on the slab.)

**You MUST have at least one or more helpers.** (Do not count the truck driver, the helper is also a safety observer.)

The pallet jack for inside the truck is to move the pallets to the back of the truck. We suggest 2 men inside and one man spotting the forklift driver. The pallet jack should have a 15-inch space between forks. Some of the pallets are made differently. If you encounter a pallet with center stringers wider than 15" (rare), then you will have to put the forks on one side of the center boards and balance the pallet to move it. If you are experienced, then you may be able to unload with one man inside and the forklift driver. An extra man on the slab to stage pallets with another pallet jack is very efficient.

We also stage our pallets according to the jobsite. We always unload and work on the poured slab (never in the dirt) for safety reasons. We try to keep the pallets on the center of the projects so we can use our rolling scaffolding to help stack block when we get to about head height with the wall height.

**Builder's Tip:** Having a pallet jack available when you build is a good technique. You can wheel a pallet of block up close to your work area for easier block retrieval when stacking block in rapid succession, saving time and effort.

Be careful of the edges and corners of the block when unloading. And remember there is NO BAD BLOCK! Our block, if broken during unloading or shipping can be glued back together and it will be perfect again.

Please be safe. And always practice safety. Thank you for choosing The Perfect Block™!



## FOUNDATION CONSTRUCTION

### Foundation Requirements

Construct your footings IAW with your chosen footing design from the foundation choices depicted in Section 5 and/or your engineered design plans. The footing depths must comply with the regional design criteria for your location found in the International Residential Code (IRC).

### Footing Layout

- After choosing where the footprint of your home is to be located, place batter boards and string the footing layout IAW your design plans
- To check the string lines for square and to verify corners are 90-degree angles:

Technique: Use the 3-4-5 triangle or multiples of the 3-4-5 triangle (6-8-10, 9-12-15, 12-16-20, etc.), (Fig. 6.1). Using the largest multiple of the 3-4-5 triangle you will give you the greater accuracy.

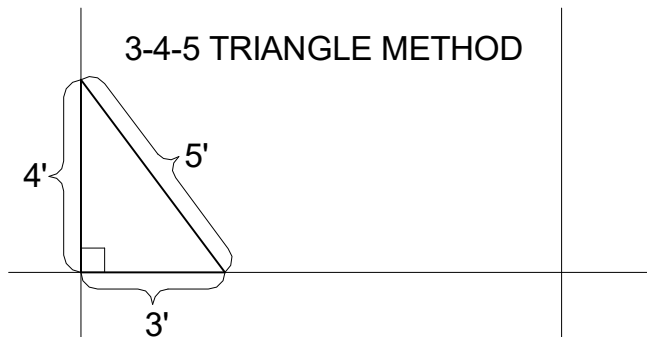

Figure 6.1

- The method above is a shortcut method using the "Pythagorean Theorem" (Fig. 6.2). It's an easy way for us lesser mortals to use the theorem and the properties of a right triangle to provide accurate square corners without the higher math. For all you "Einsteins" out there that want to use all the length of a long wall (A) and the length of the adjacent wall (B), to determine the length of the hypotenuse (C), the formula is  $A^2 + B^2 = C^2$  (See Fig. 6.2 on following page). The square root of  $C^2$  will give you the length of the hypotenuse (C) of your unique right triangle and possibly a more precise square corner.

## FOUNDATION CONSTRUCTION

### Footing Layout (Cont.)

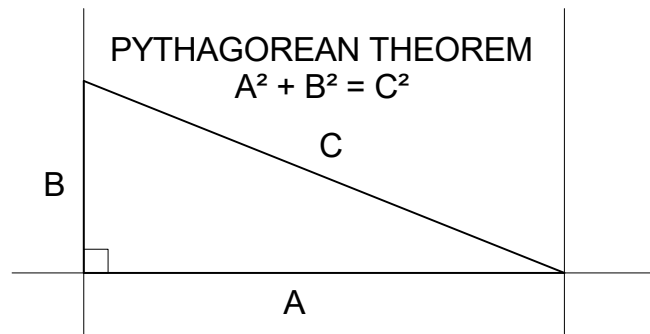

Figure 6.2

- Another method to check for square for square/rectangular buildings is diagonal squaring. Measure diagonally across to the opposite corner each way, A & B, Fig. 6.3. The corners are square when the dimension A = B.

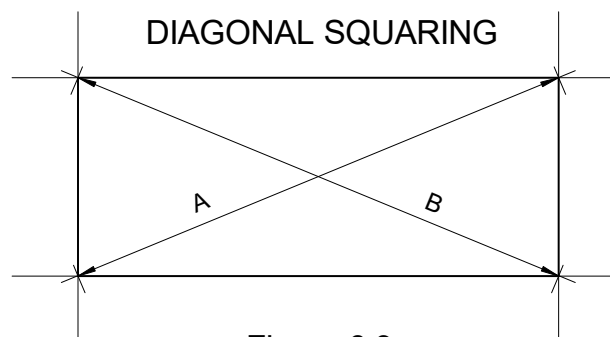

Figure 6.3

- Transfer the building lines from the string lines to the top of the footings using a plumb bob or a level.

### Footing Construction

- Level footings should be designed to transfer and distribute the load they will support and be in compliance with governing building regulations.
- Dig footing IAW your design plans and selected footing and slab design and place horizontal rebar on concrete dobies or blocks to support the footing rebar a minimum of 3" above the bottom of excavated footing.

## FOUNDATION CONSTRUCTION

### Footing Construction (Cont.)

- Place the vertical steel reinforcing (rebar) dowels in the footing at intervals and with the proper rebar overlap specified by your design. This will provide solid wall attachment to footings. Further guidance for vertical rebar placement is in the details: FDN (FOUNDATION) VERTICAL REINF PLACEMENT on the following pages to ensure proper alignment of vertical steel with ICCF block cores. Several methods can be used to hold vertical rebar in place.

**Builder's Tip:** Rebar can be cut to lengths that are usable later in construction and used for temporary upright stakes and bridges to hold long sticks of rebar that can be used to temporarily tie the vertical rebar in the footing to keep perfect placement until after the footing concrete is poured.

Added  
9/06/21

Placing the steel properly for the chosen block thicknesses before you pour footing concrete, makes your first course block placement a pleasing and fun labor. If you misplace a few verticals and have to bend them into place to slip into the block internal cores, that is no big deal. But having to bend 200 pieces of steel to make them fit the cores, is a miserable day of labor that you will wish you paid much more emphasis on the proper vertical rebar placement. If you have someone constructing your foundation, make sure they are using the provided details for your chosen block for proper vertical rebar placement and check their work before the concrete is poured. (Unfortunately, some foundation contractors not checking and using the vertical rebar placement details to build ICCF footings, is an all too common occurrence.)

- Before any concrete is poured for the footing, stem wall, any foundation penetrations must be planned and constructed. Before the slab is poured, all under slab plumbing and electrical utilities must be completed and inspected.
- Strive to pour level footings within a vertical tolerance of plus or minus 1/8 inch. Having a level footing and/or a level first course is critical to minimizing future problems and errors with subsequent courses. "Square and plumb and level construction saves time and money".

***"Safety Alert!: First and foremost when working with rebar, Wear Eye Protection! and to prevent further injury, it is very important that safety protection caps be placed over footing vertical rebar after they are installed. Remove caps from rebar as the block courses are placed and/or when they are no longer a safety hazard."***

**Note:** Safety protection caps can be rented or purchased at a concrete supply store or ordered online..

## FOUNDATION CONSTRUCTION (Cont.)

### Electrical & Plumbing Considerations

Penetrations through the footing or stem wall for electrical conduit and supply and drain/waste/vent (DWV) plumbing can be accomplished during foundation construction IAW your design plan. During the design phase, your architect or designer should plan to run whenever possible as many utilities through the footing or stem wall into the interior of the building if required or more simply through the exterior wall or into the attic and run up partition walls as required. DWV plumbing can be run through cores in the ICCF walls, although not an ideal method. If these runs must be placed within the cores of the ICCF walls by design, then placement of these plumbing runs must be made before the walls are grouted. Water supply piping can also be run through ICCF walls but smaller diameter piping allows for placement within the interior core face of the ICCF wall after grouting. Again, the design should strive to place supply piping and DWV plumbing within a 2X6 or wider interior partition wall when possible.

### Footing and Stem Wall Construction

**Important note:** Reference the detail on the following page (Fig. 6.4) for placement of vertical steel reinforcement dowels (rebar) in the footing. The position of the vertical portion of the rebar that protrudes above the top of slab or top of stem wall will be the same regardless of the type of footing selected (**Exception:** The centering offset dimension (COD, See following detail) will change with the thickness of the wall block chosen for your building project, Example: 8" COD = 4"; 10" COD = 6").

## FOUNDATION CONSTRUCTION

### Footing and Stem Wall Construction (Cont.)

For proper alignment with the vertical cores of EBS block place vertical rebar dowels in the footing and stem wall as depicted in the following details.

UPDATED 4/09/19

PRIOR TO FDN CONCRETE POUR:

**10" ICCF WALL**

## FOUNDATION VERTICAL REINF PLACEMENT

### (#4's @ 24" O.C.) IN FOOTING FOR 10" THICK ICCF

#### IMPORTANT NOTE TO STEELWORKERS:

1. FOUNDATION VERTICAL REINF PLACEMENT IS CRITICAL TO PROPER WALL BLOCK CORE ALIGNMENT WHEN USING THE "NO CUT" CORNER CONSTRUCTION WITH AN ICCF CORNER BLOCK.
2. ALL FDN VERTICAL #4 REINF SHALL EXTEND A MIN OF 24" ABOVE T.O. STEM WALL OR T.O. SLAB ON A MONOLITHIC FDN FOR WALL REINF LAP SPLICE.

#### SUGGESTED STEEL PLACEMENT METHOD FOR 10" BLOCK/24" O.C.:

1. BEGIN AT ANY BUILDING CORNER, WORK CLOCKWISE.
2. PLACE FIRST CORNER VERTICAL REINF 6" FROM LEFT SLAB EDGE OR STEM WALL EXT FACE AND 6" FROM TOP SLAB EDGE OR STEM WALL EXT FACE (AS DEPICTED).
3. PLACE NEXT VERTICAL REINF @ 4" FROM FIRST VERTICAL (10" FROM SLAB EDGE), THEN PLACE ALL SUBSEQUENT VERTICALS @ 24" O.C. OR IAW DESIGN PLAN INTERVAL UNTIL REACHING THE NEXT CORNER.
4. BEGIN AGAIN AT NEXT CORNER.

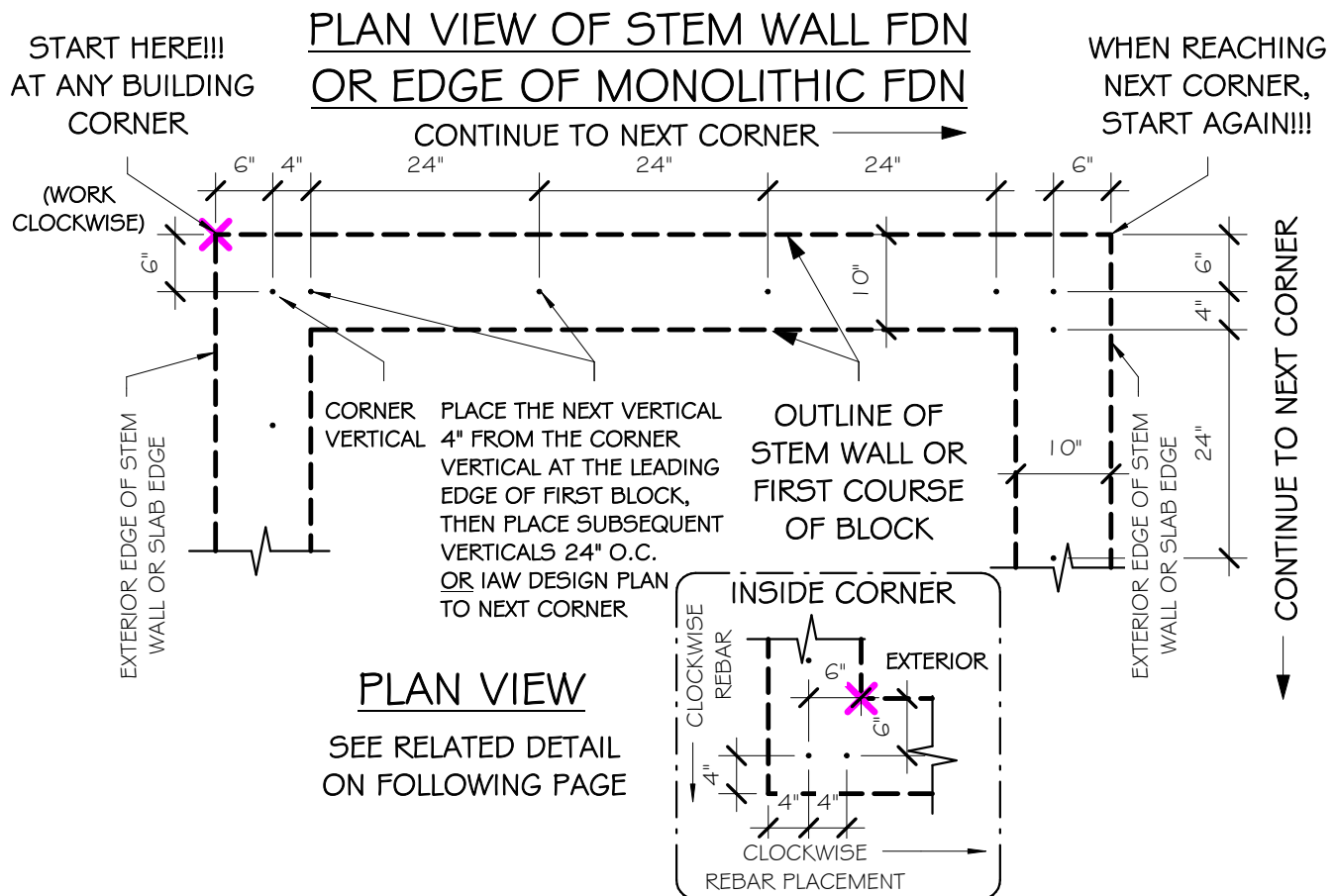

## FDN VERT REINF PLACEMENT/10" ICCF WALL

NOT TO SCALE

## FOUNDATION CONSTRUCTION

### Footing and Stem Wall Construction (Cont.)

The detail below shows a plan view of properly placed vertical rebar in the footing with the proper placement of the first course of ICCF block over the footing.

UPDATED 4/09/19

THE FOLLOWING DETAIL IS  
A RELATED VIEW TO DETAIL  
ON PREVIOUS PAGE

**10" ICCF WALL**

## FOUNDATION VERTICAL REINF PLACEMENT (#4's @ 24" O.C.) IN FOOTING FOR 10" THICK ICCF BLOCK

### VIEW OF REINF PLACEMENT WITH 10" ASYMMETRIC ICCF BLOCK OVERLAY

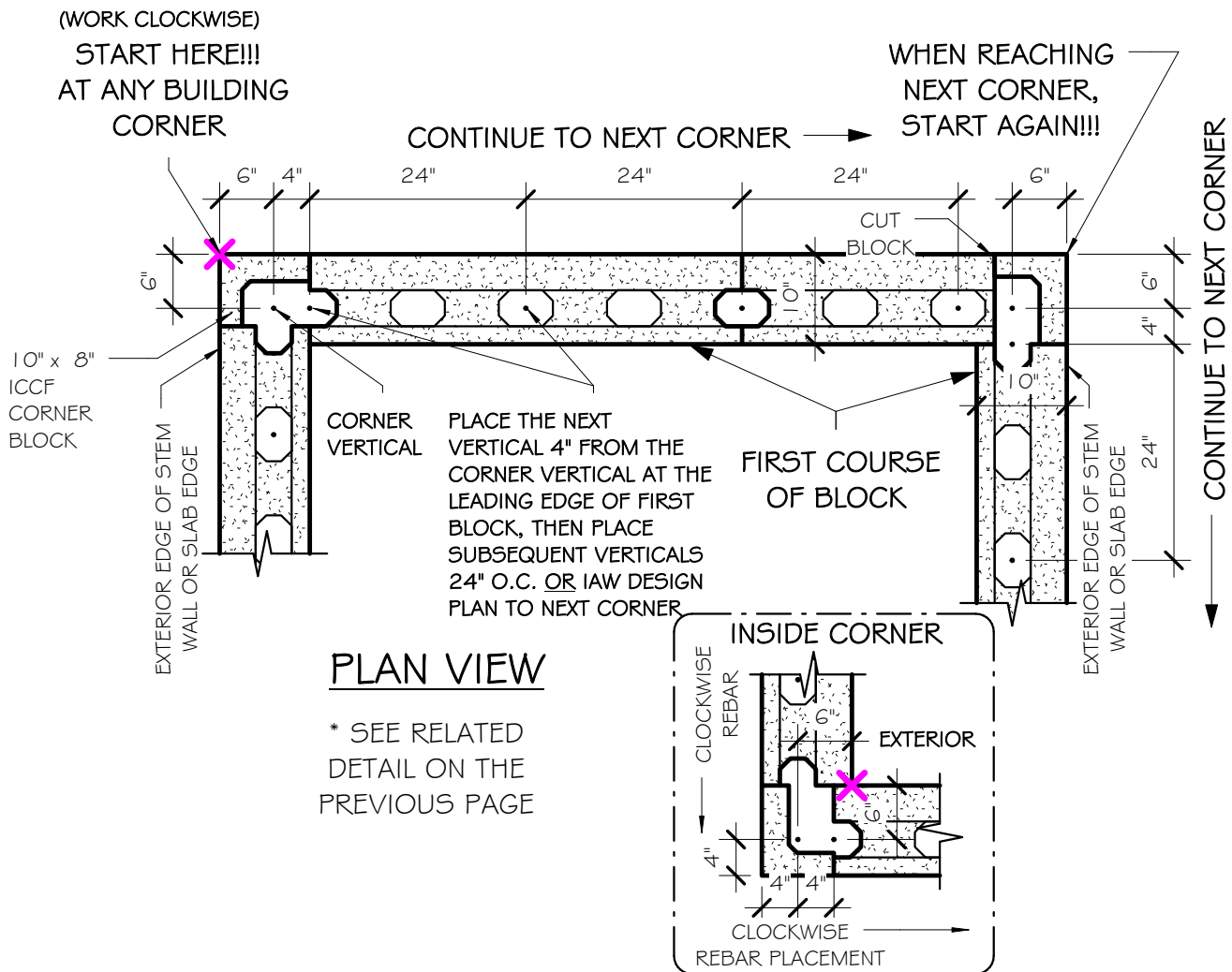

## FDN REINF PLACEMENT/10" BLK OVERLAY

NOT TO SCALE

## FOUNDATION CONSTRUCTION

### Footing and Stem Wall Construction (Cont.)

UPDATED 3/20/20

PRIOR TO FDN CONCRETE POUR:

**8" ICCF WALL**

## FOUNDATION VERTICAL REINF PLACEMENT (#4's @ 24" O.C.) IN FOOTING FOR 8" THICK ICCF BLOCK

### IMPORTANT NOTE TO STEELWORKERS:

1. FOUNDATION VERTICAL REINF PLACEMENT IS CRITICAL TO PROPER WALL BLOCK CORE ALIGNMENT.
2. ALL FDN VERTICAL REINF SHALL EXTEND A MIN OF 24" ABOVE T.O. STEM WALL OR T.O. SLAB ON A MONOLITHIC FDN FOR WALL REINF LAP SPLICE.

### SUGGESTED STEEL PLACEMENT METHOD FOR 8" BLOCK/24" O.C.:

1. BEGIN AT ANY BUILDING CORNER, WORK CLOCKWISE.
2. PLACE FIRST CORNER VERTICAL REINF 4" FROM LEFT SLAB EDGE OR STEM WALL EXT FACE AND 4" FROM TOP SLAB EDGE OR STEM WALL EXT FACE (AS DEPICTED).
3. PLACE NEXT VERTICAL REINF @ 4" FROM FIRST VERTICAL (8" FROM SLAB EDGE), THEN PLACE ALL SUBSEQUENT VERTICALS @ 24" O.C. OR IAW DESIGN PLAN INTERVAL UNTIL REACHING THE NEXT CORNER.
4. BEGIN AGAIN AT NEXT CORNER.

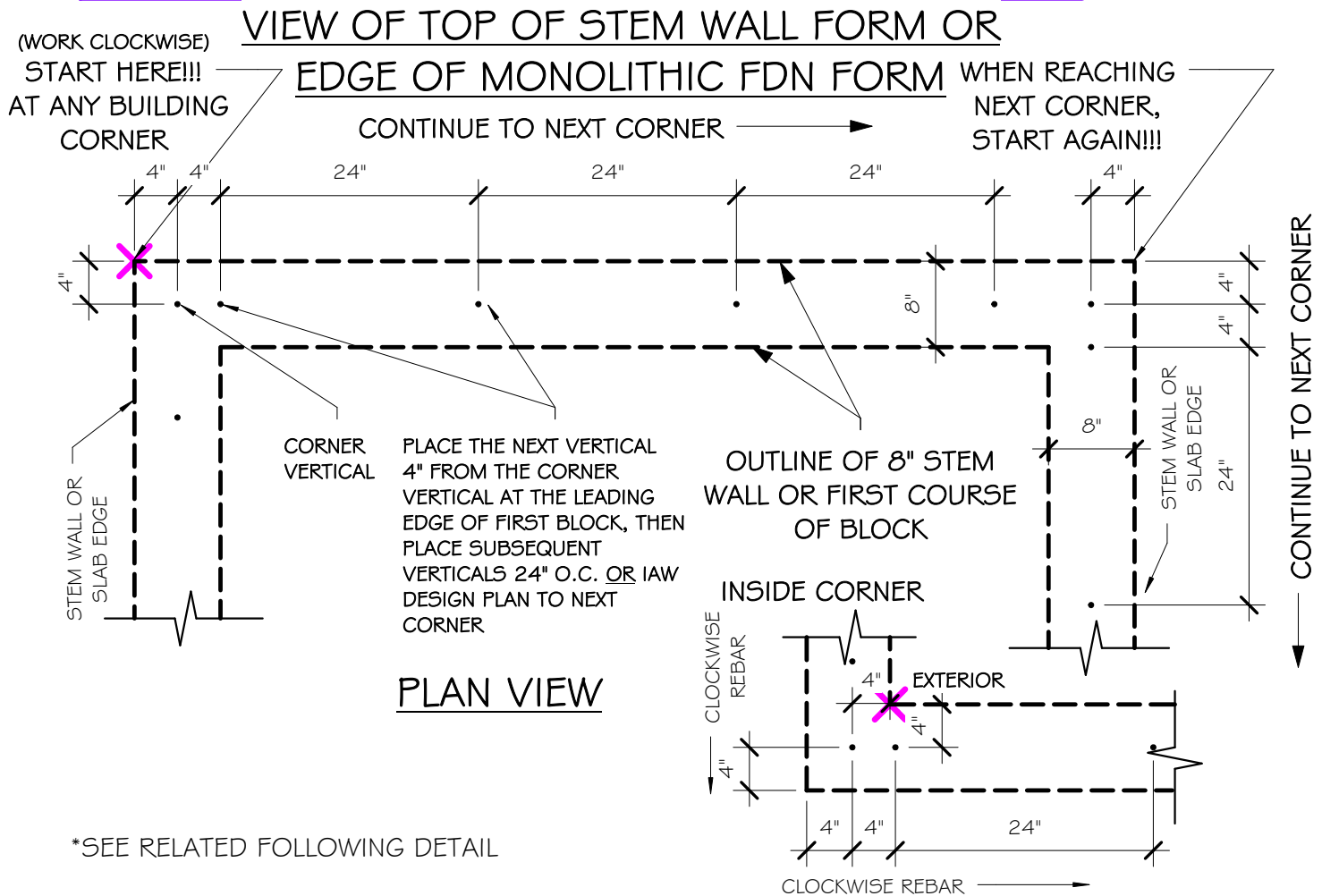

\*SEE RELATED FOLLOWING DETAIL

## FDN REINF PLACEMENT/8" ICCF WALL/24" O.C. (a)

SCALE: 3/4" = 1'-0"

6.4a-a

## FOUNDATION CONSTRUCTION

### Footing and Stem Wall Construction (Cont.)

The detail below shows a plan view of properly placed vertical rebar in the footing with the proper placement of the first course of ICCF block over the footing.

UPDATED 3/20/20

8" ICCF WALL

## FOUNDATION VERTICAL REINF PLACEMENT (#4's @ 24" O.C.) IN FOOTING FOR 8" THICK ICCF BLOCK

### TOP VIEW OF REINF PLACEMENT WITH 8" CORE ICCF BLOCK OVERLAY

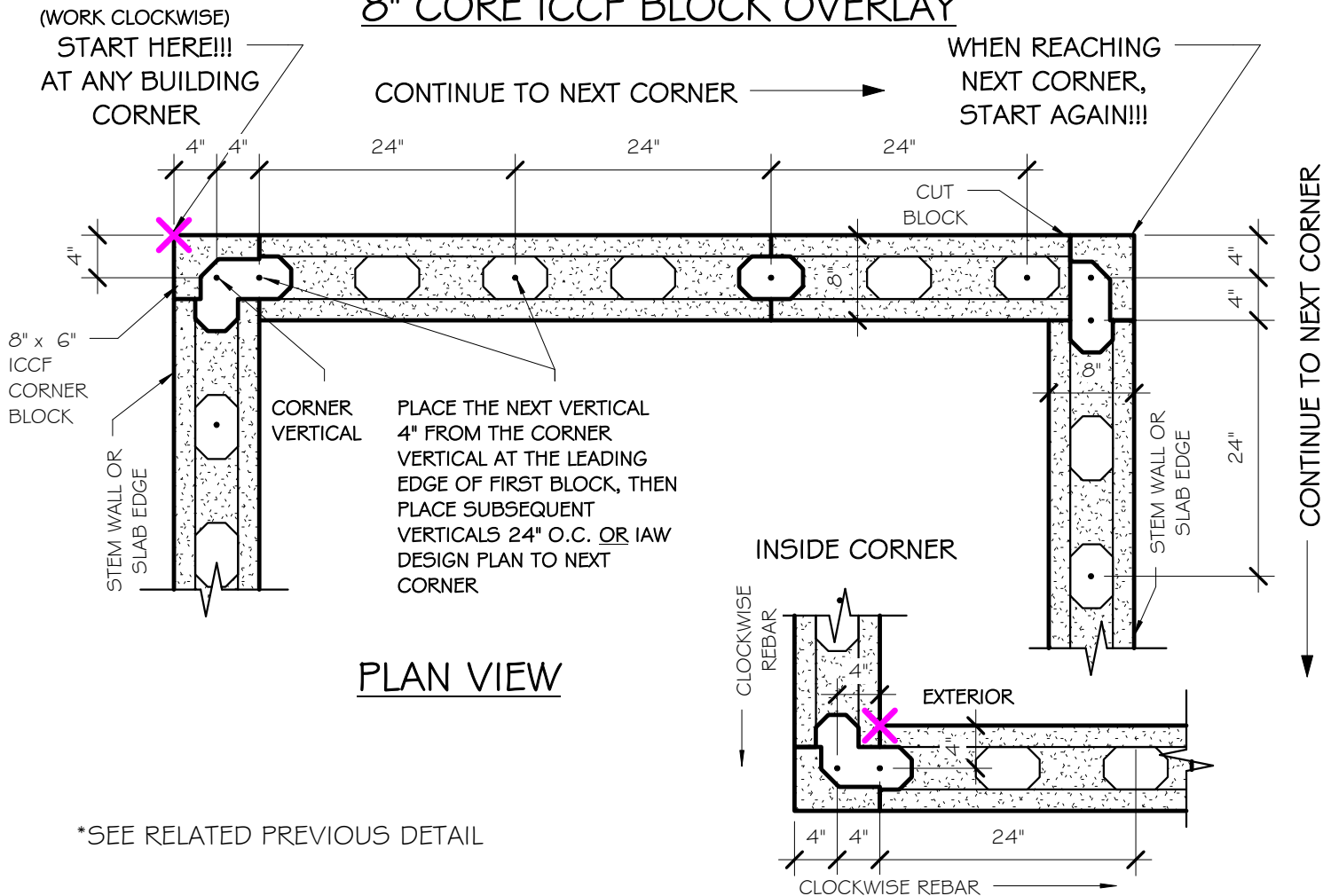

## FDN REINF PLACEMENT/8" BLOCK OVERLAY/24" O.C. (b)

SCALE: 3/4" = 1'-0"

## FOUNDATION CONSTRUCTION

### Footing and Stem Wall Construction (Cont.)

For proper alignment with the vertical cores of EBS block place vertical rebar dowels in the footing and stem wall as depicted (See detail on page 6.4a).

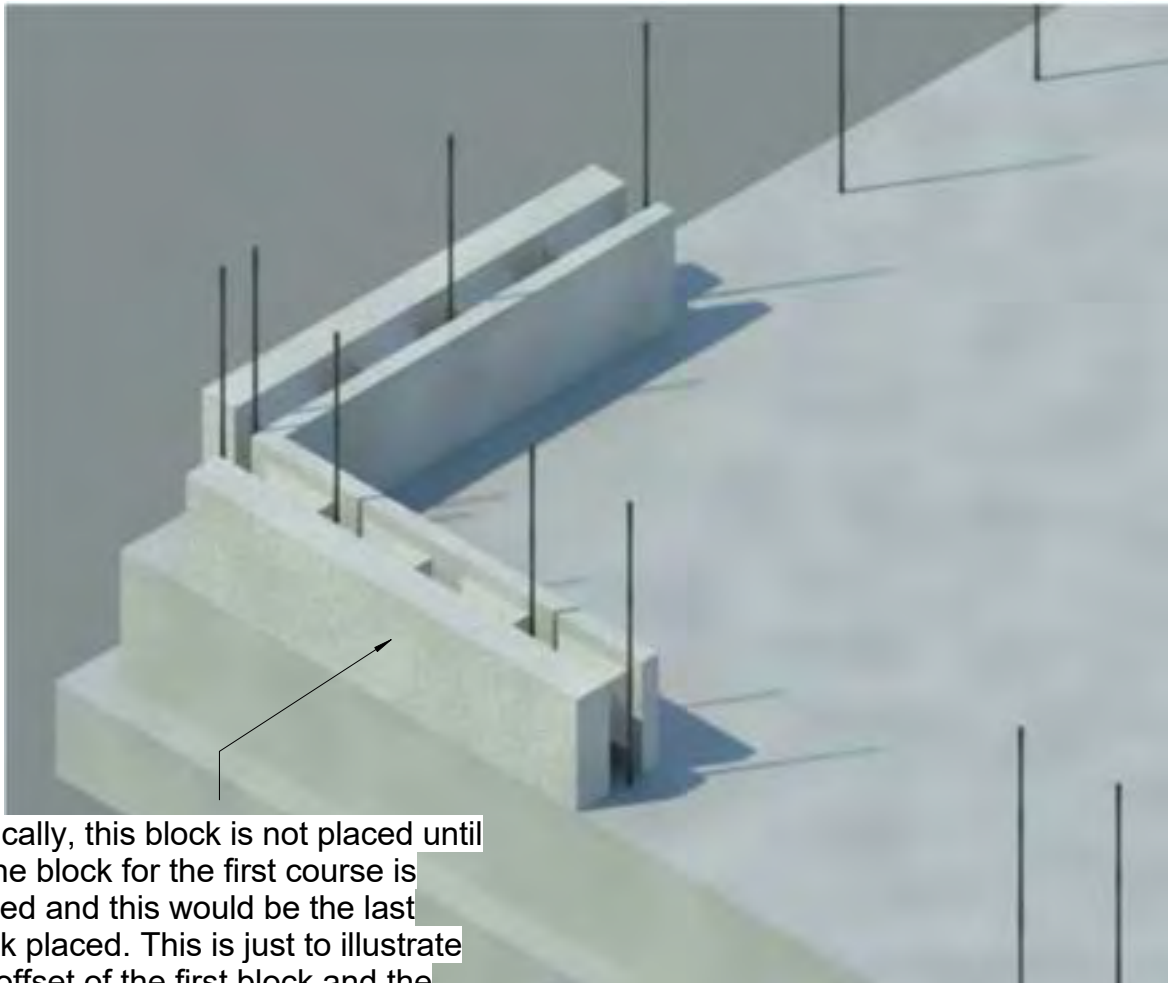

Typically, this block is not placed until all the block for the first course is placed and this would be the last block placed. This is just to illustrate the offset of the first block and the block from the perpendicular wall to accommodate the footprint of a corner block on its end.



## FOUNDATION CONSTRUCTION

### Footing and Stem Wall Construction (Cont.)

The rendering below shows a 3D view of properly placed vertical rebar in a strip footing and stem wall footing without a slab. Note the dropped thresholds in the stem wall at the door locations.

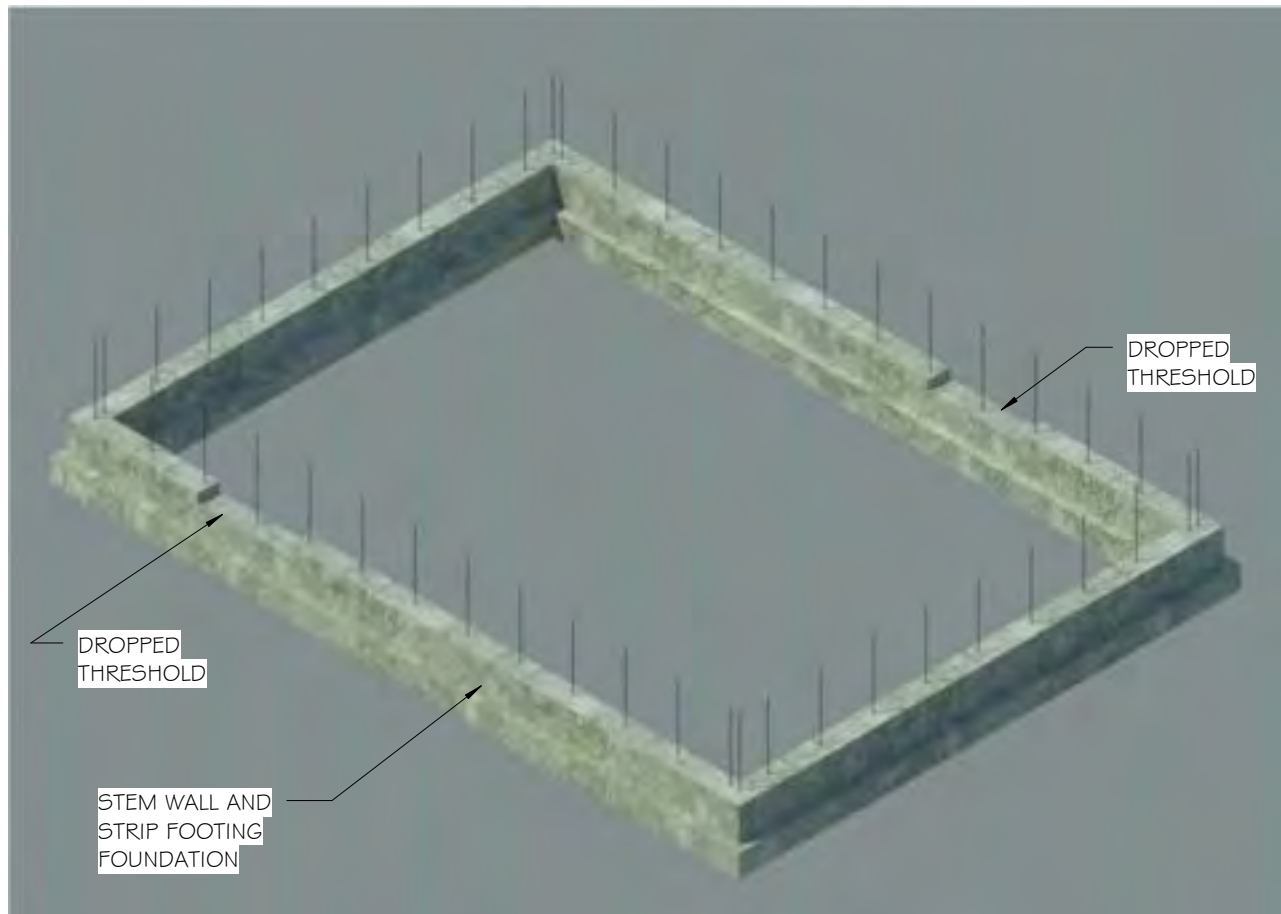

## FOUNDATION CONSTRUCTION

### Footing and Stem Wall Construction (Cont.)

The rendering below shows a 3D view of the strip footing and stem wall foundation with a floating slab. Note the slab creating the thresholds at the door locations.

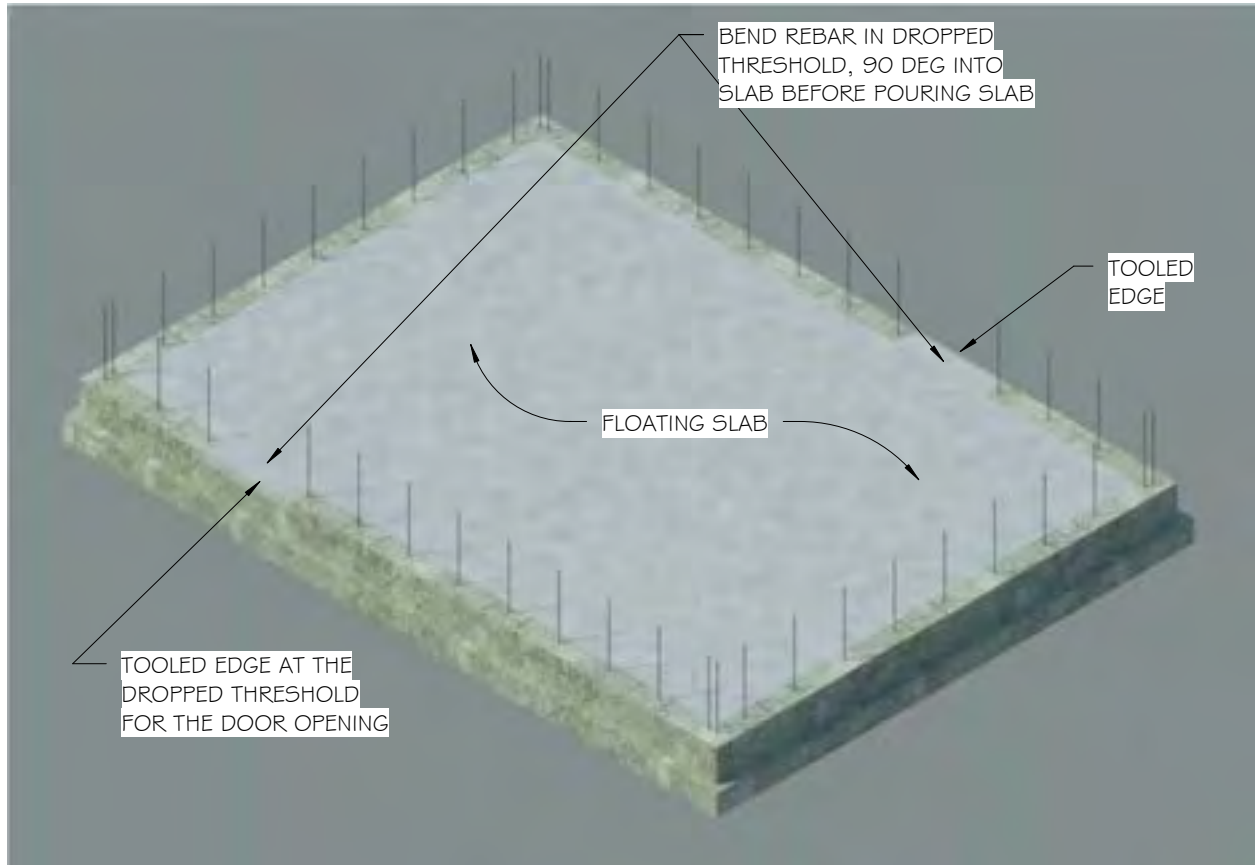

## FOUNDATION CONSTRUCTION

### Footing and Stem Wall Construction (Cont.)

The rendering below show a 3D view of a properly placed first block of the first course of a 10" Asymmetric ICCF wall. Subsequent block is placed one after the other to the next corner.

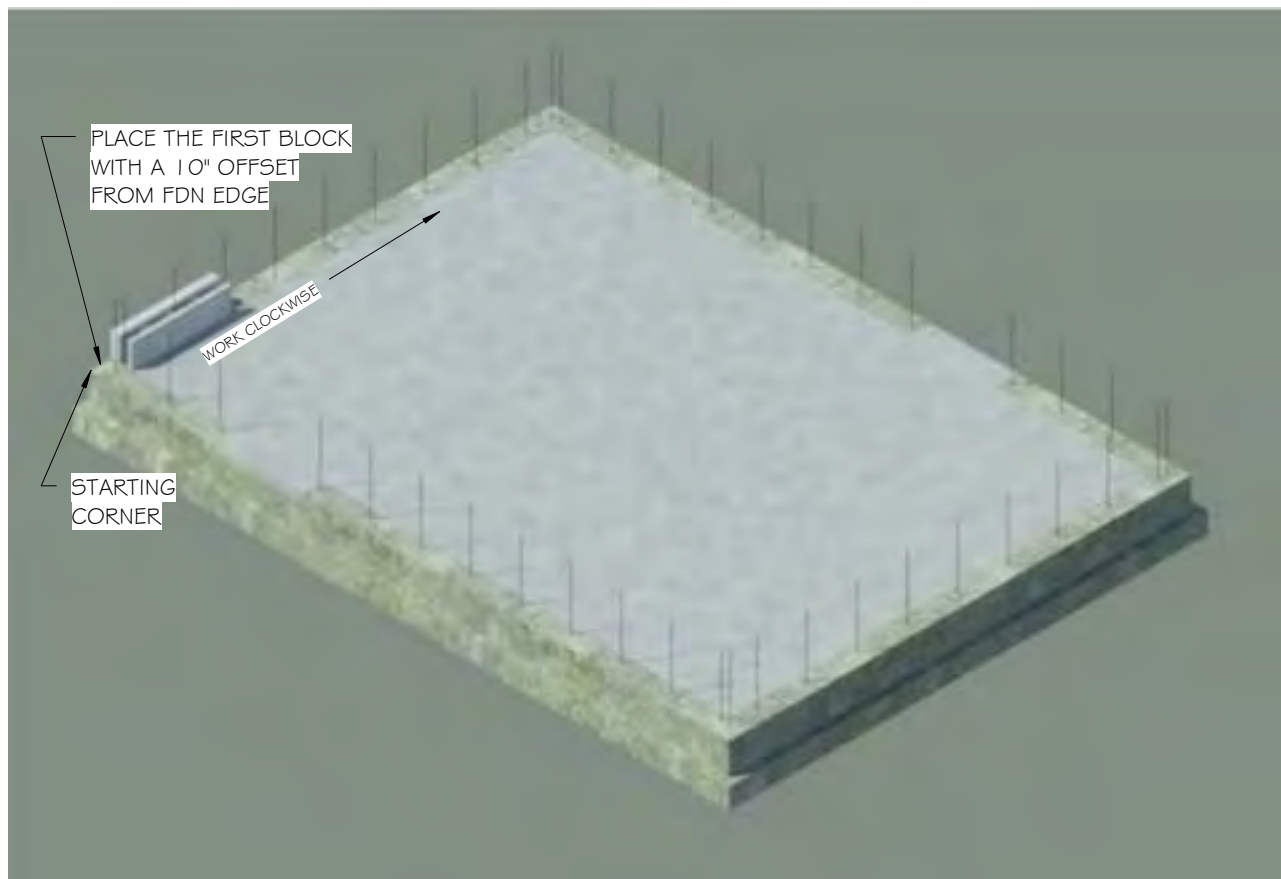
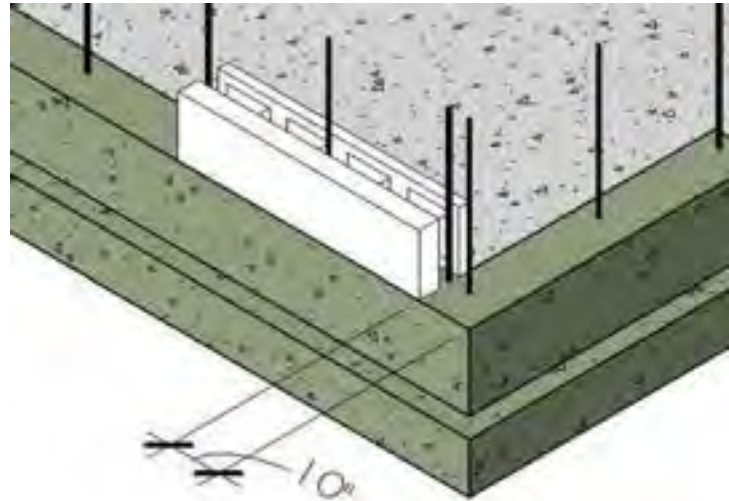

## FOUNDATION CONSTRUCTION

### Footing and Stem Wall Construction (Cont.)

The start block from the next corner is placed with 10" offset, just like the first wall. The gap left for the last block is 11", leaving an offset of 8" to accommodate the 8" leg of a 10" corner block on end, to be installed vertically.

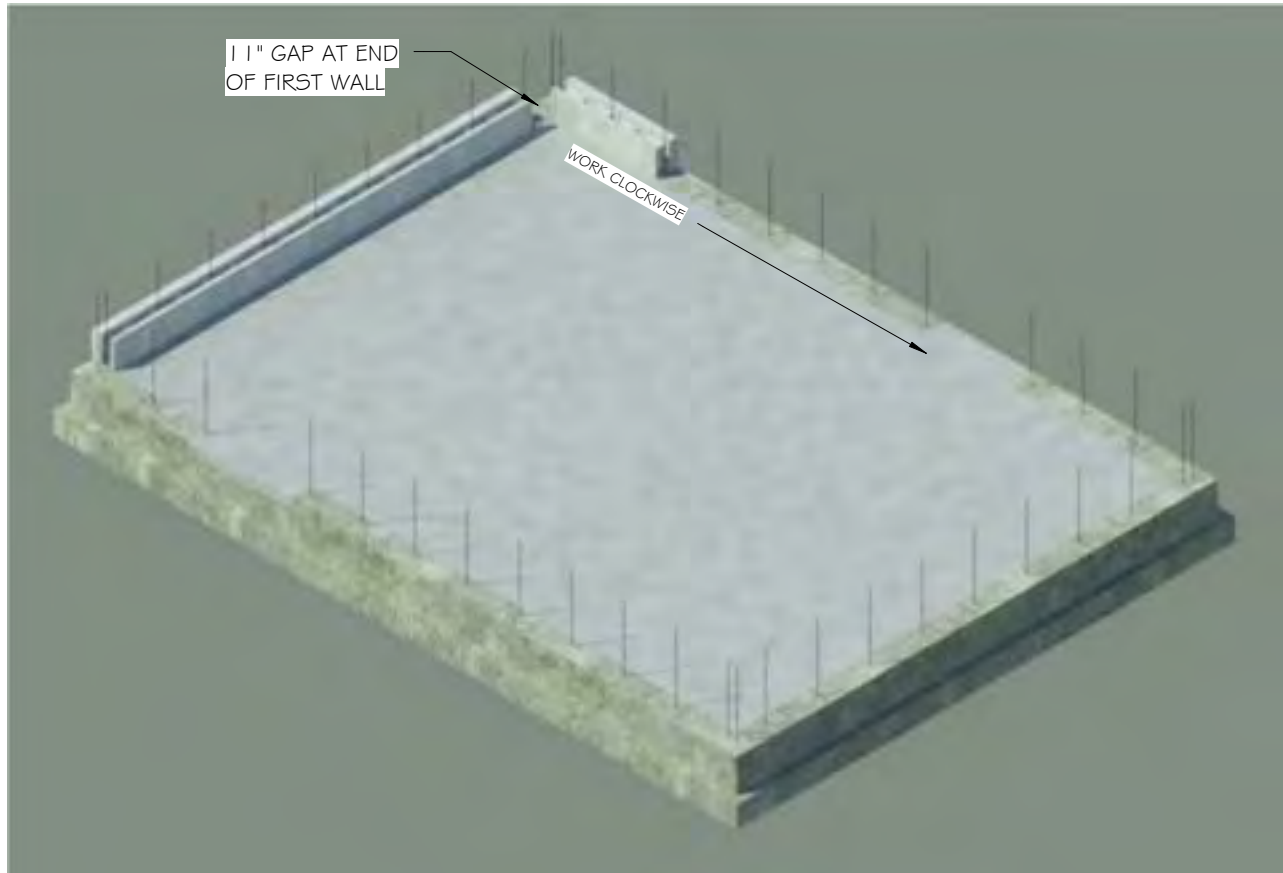

## FOUNDATION CONSTRUCTION

### Footing and Stem Wall Construction (Cont.)

The 11" gap will accept a "ripper" block (a block with 1" of height ripped off lengthwise with a circular saw and guide fence) placed vertically. Using a standing ripper in a gap of less than 12" will cover four courses and save from cutting four 11" long blocks for four courses.

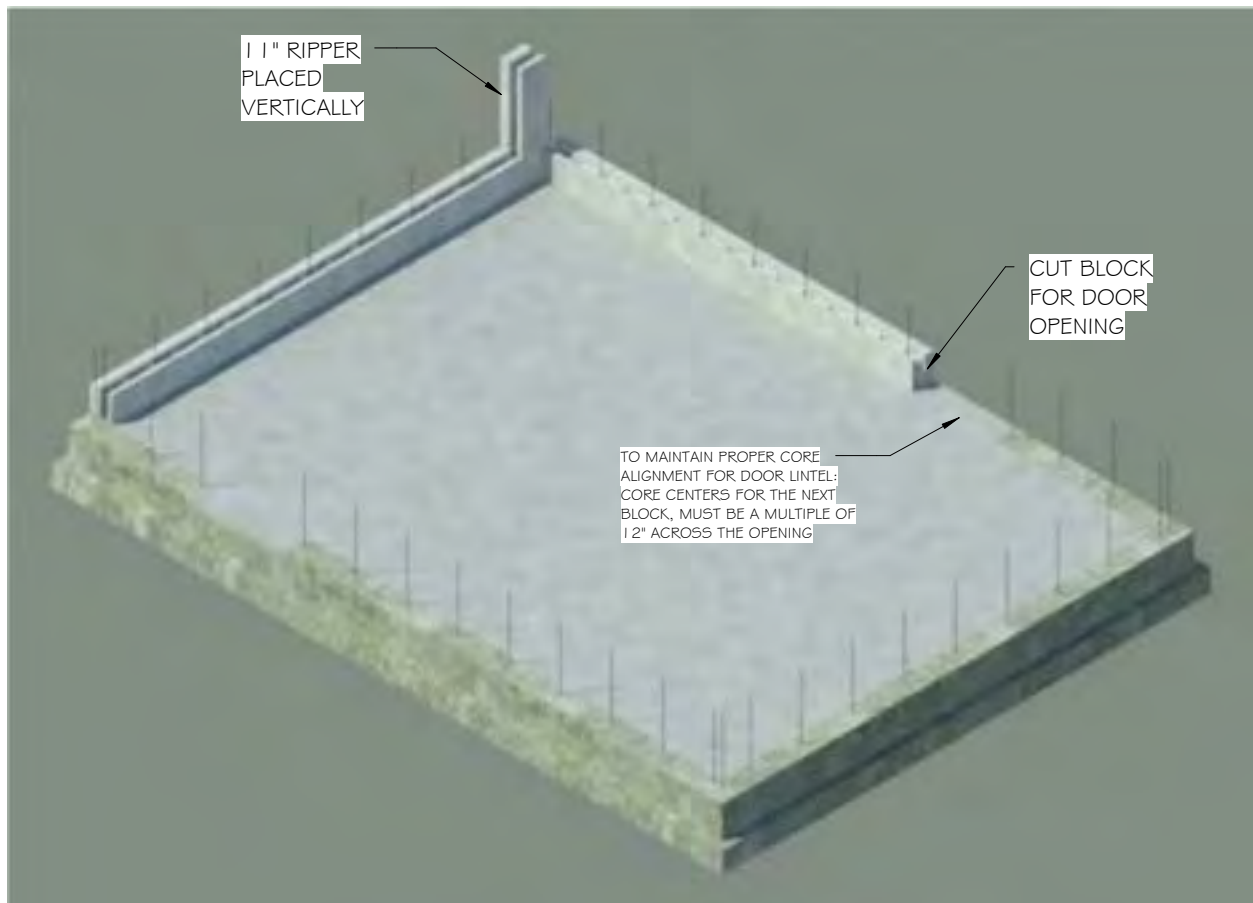

## FOUNDATION CONSTRUCTION

### Footing and Stem Wall Construction (Cont.)

On the second wall, the left edge of the door (looking from the inside), a cut block was needed to the left edge of door opening. Measure the opening width, and another cut block is needed. The far end of the cut block on the other side of the door must equal a multiple of 12" from the factory edge of the cut block left of the door (in this case, it is 8') to ensure the 12" on center vertical core alignment across the door lintel.

Possibly a simpler method is to stack uncut block end to end, measure the door center point, mark the edges and cut out the block for the door opening. Then use the cut out piece, later in the build.

The end block of the second wall ended with a full block, so there was no need for a cut block or standing ripper. The third wall started with same offset and ended with another 11" ripper like the first wall.



## FOUNDATION CONSTRUCTION

### Footing and Stem Wall Construction (Cont.)

The first course is now complete. Note the 6" ripper at the door opening and another 6" ripper at the end of the fourth wall.

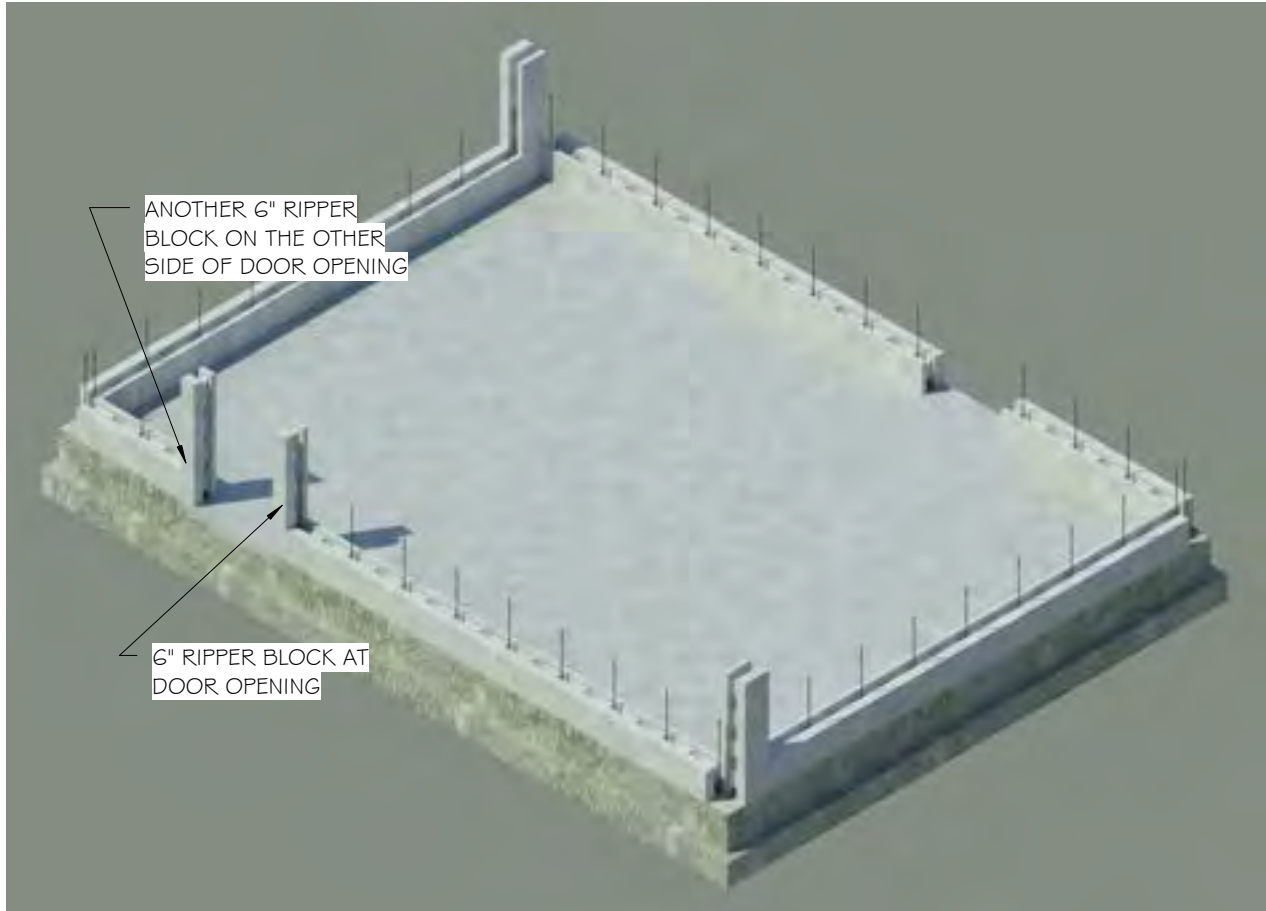

Ripper examples in this model

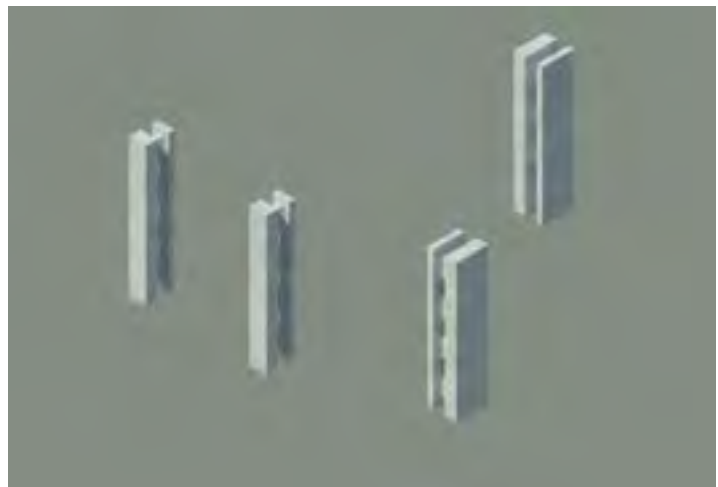
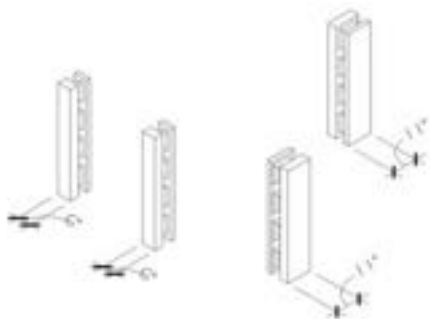

## **FOUNDATION CONSTRUCTION**

### **Footing and Stem Wall Construction (Cont.)**

The second course should go much quicker using a "stack bond" since the second course will be identical to the course below.

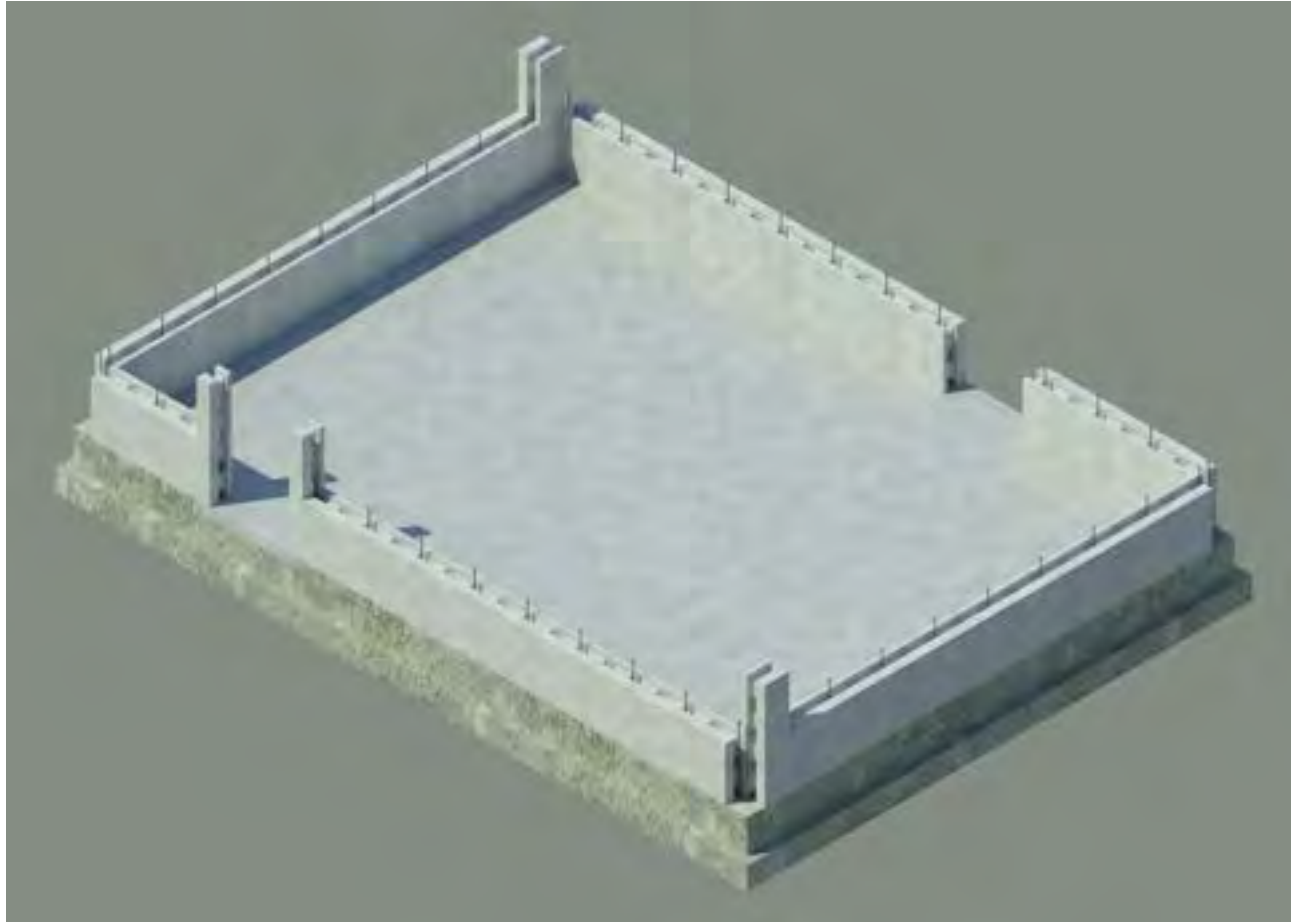

## **FOUNDATION CONSTRUCTION**

### **Footing and Stem Wall Construction (Cont.)**

Now that at least 2 courses are set. Let's add 10" corner blocks to all four corners.

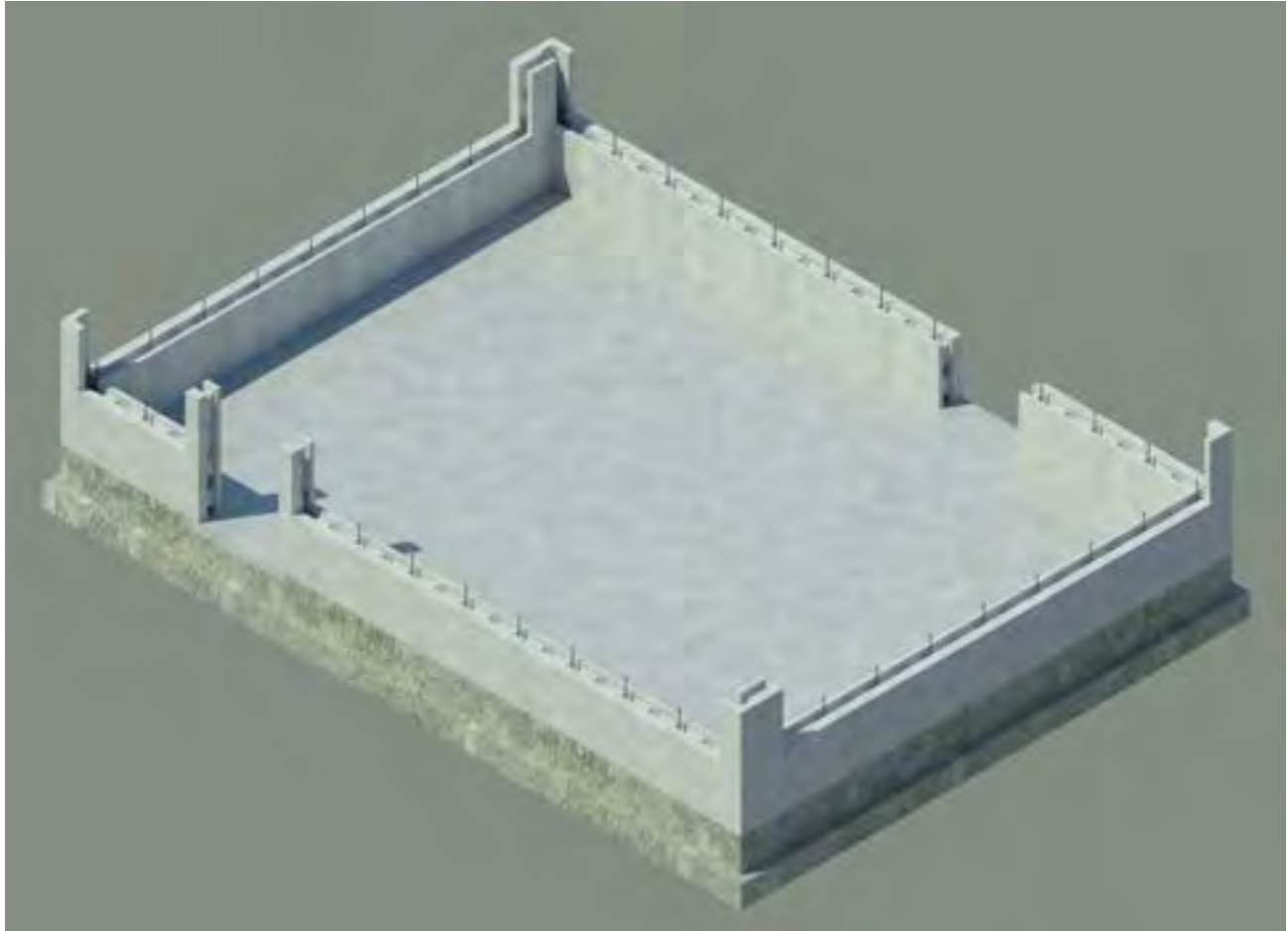

## **FOUNDATION CONSTRUCTION**

### **Footing and Stem Wall Construction (Cont.)**

The third course is placed and complete.

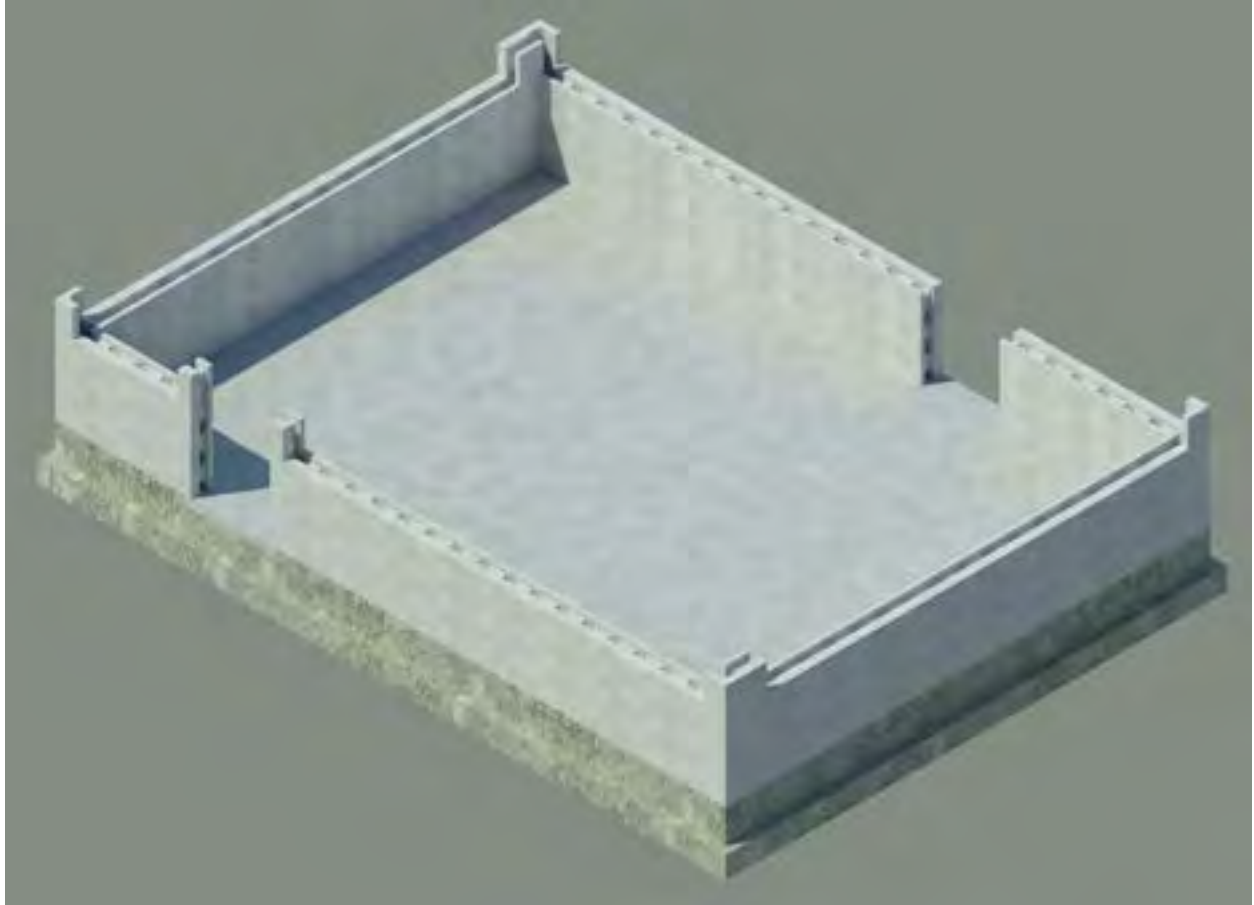

The sequential pictorial of this building construction continues from the third course to the ninth course, grout, and placement of the top plate on page 7.5a.

## FOUNDATION CONSTRUCTION

### Footing and Stem Wall Construction (Cont.)

**Builder's Tip (or maybe just an opinion):** (If your choice for your foundation is a monolithic footing and slab, then this tip is not applicable. With this type of foundation, you will already have a slab from which to work safely). If your foundation choice is a strip footing and stem wall, then once the footing and stem wall are complete, we recommend that you bring in the appropriate fill and compact it, then pour your slab before proceeding with ICCF wall construction (of course, your underslab plumbing or wiring must be completed before pouring the slab, so schedule accordingly). Pouring a slab before starting to build your wall is not a requirement, but in our building experience, having a slab to place your pallets of block in the center of your work area, free from trip hazards and obstacles and being able to roll your scaffolding with ease instead of carrying it, and having a level floor to construct your walls is a sensible and inherently safer choice over a dirt base. Also, if you have a pallet jack, you can move your pallets of block close to your work area. We only make this comment because we have seen photos of several ICF jobsites, that are building from the dirt without a slab.....it's a head scratcher for us. We wanted to urge you not to do that. Let's face it, why would you work in the dirt if you didn't have to do so. All the reasons given why you must work in the dirt, pale in comparison to the safety and comfort provided by a safe, smooth, hard surface from which to work.

Yeah we know, it's just an opinion.

Changed  
1/19/23

## FOUNDATION CONSTRUCTION

### Creating a Brick Ledge

One simple method to create a Brick Ledge when using the ICCF block to create a stem wall on a strip footing instead of a poured concrete stem wall or monolithic footing is to use a line of horizontal 8" ICCF corner blocks supported by threaded rod and nuts and jobsite made washers in an upright "L" position to form a brick ledge.



Strip footing with vertical rebar in place.

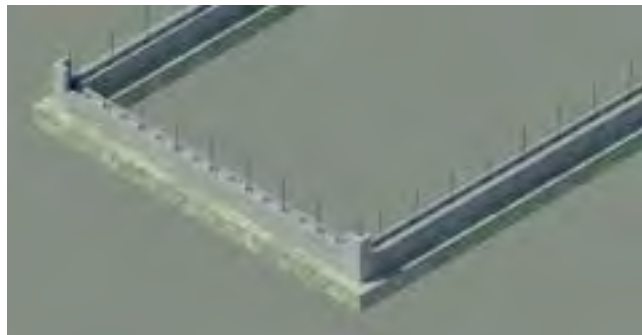

Strip footing with first course of block of ICCF stem wall installed.

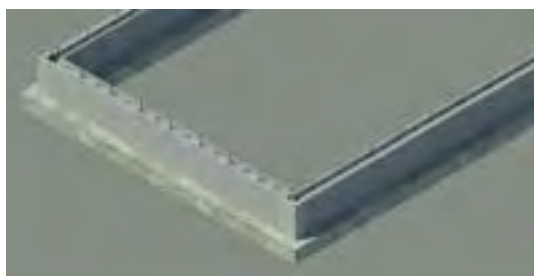

Strip footing with second course of block of ICCF stem wall installed. The top of this course of block will be the floor height of your floor slab. Note: The top of stem wall block course is unmodified.

Note: The strip footing would have been in an excavated trough of dirt in the natural grade that is not shown.

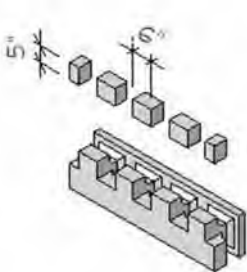

Modify each block of the second course or the top course of the stem wall depending on the depth of your strip footing by cutting out 6" wide by 5 to 6" deep notches in the exterior face of each block. Make sure each notch is aligned with the vertical cores. These will be flow channels for concrete into the horizontal corner block creating the brick ledge. Each notch will have an 90 deg angle rebar to support a horizontal rebar stick, parallel with the wall and in the brick ledge.

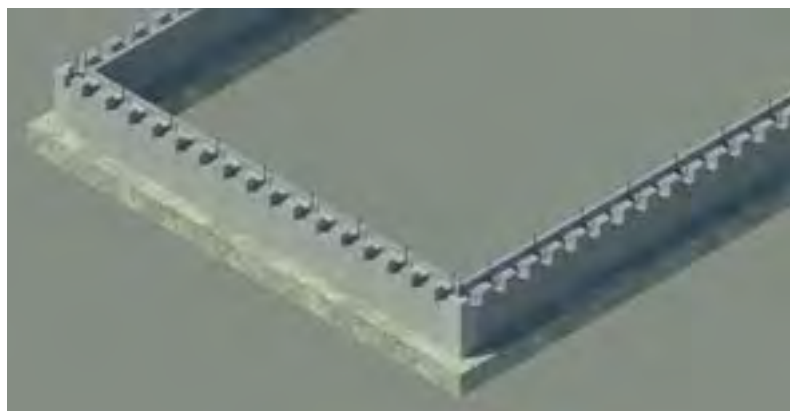

Now that the top course has flow notches at each vertical core, the 8" corner blocks can be secured to the exterior face of the top block with threaded rod, nuts, and 3"x3" plywood washers.

Note: The corner blocks are notched to carry the brick ledge around the building corner.

## FOUNDATION CONSTRUCTION

### Creating a Brick Ledge (cont.)

Added  
9/15/21

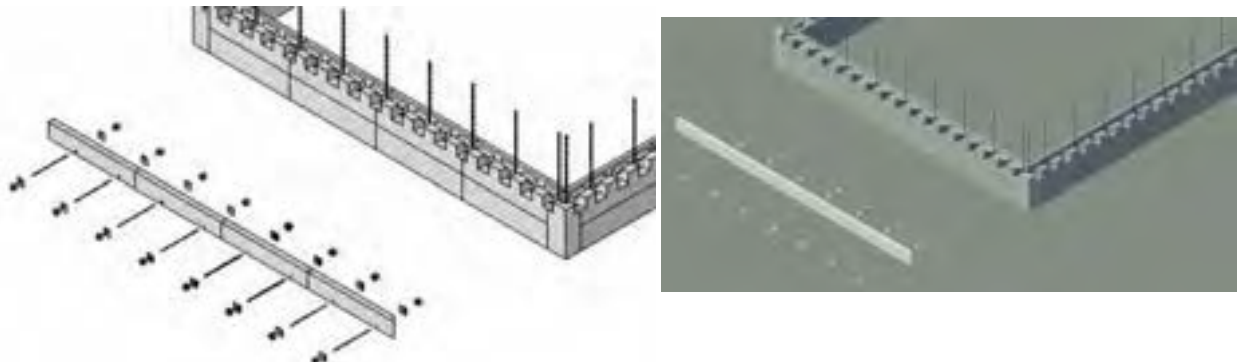

Notice that in the above illustrations, the concrete strip footing is not shown. The strip footing would be well below grade and likely not visible.

To start the brick ledge, attach the 8" corner block, horizontally, to the face of the stem wall with 3/8" threaded rod and plywood washers and nuts. Use a long shaft drill bit to accurately place the threaded rod holes and drill through the corner and wall block at least 24" on center, the length of the wall to hold each corner block in place. This has to be done before pouring concrete for the slab so the rods can be tightened on the interior face. Additionally tack the corner block with spray foam adhesive for added attachment hold.

If you place the rod holes in line with the block webs, the rods can be tapped out easily after the concrete hardens, and the holes can be filled with the spray foam, otherwise if the rods are through the cores, then you must tap out the rods when the concrete is green or cut off the exposed rod with a grinder with a cutting disc..

In this example, the top of the stem wall block is level with the top of the slab that will be poured later. The top of the brick ledge is also level with the top of the block. You may want the level of the brick ledge to be a few inches below the top of the stem wall block. If that is the case, then secure the corner block ledge form at the height you want and make your flow notches deeper to ensure a good fill in the brick ledge form. If the ledge is lower than the top of the block, use a thicker mix of concrete at the top of the wall so the brick ledge concrete can be troweled level as well as the top of the stem wall.

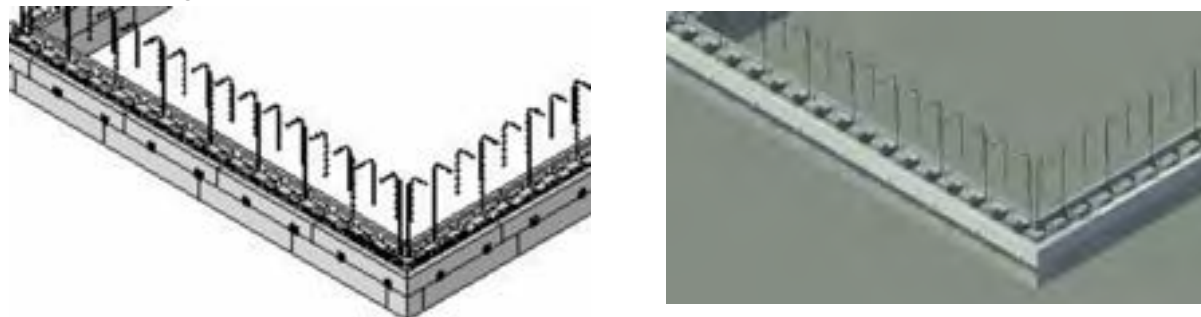

Place a vertical rebar with a hook in each flow notch at 12" on center for a full wall of brick or stone or at 24" on center if the brick or stone is a half wall. Place a long stick of rebar on the top of the vertical rebar with a hook, parallel with the stem wall. Place a 90 deg corner rebar with the proper lap splice at each brick ledge corner. Now the brick ledge and stem wall are ready for filling with grout.

## FOUNDATION CONSTRUCTION

### Creating a Brick Ledge (cont.)

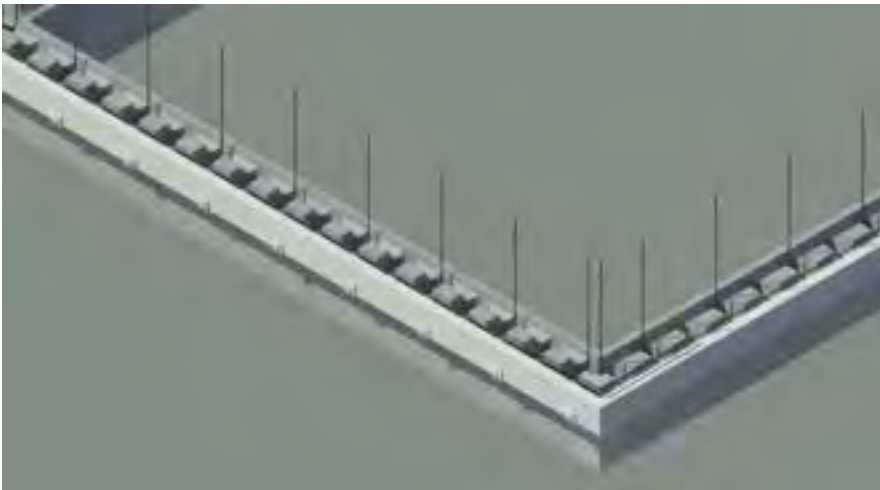

Brick ledge and stem wall are ready for grout.

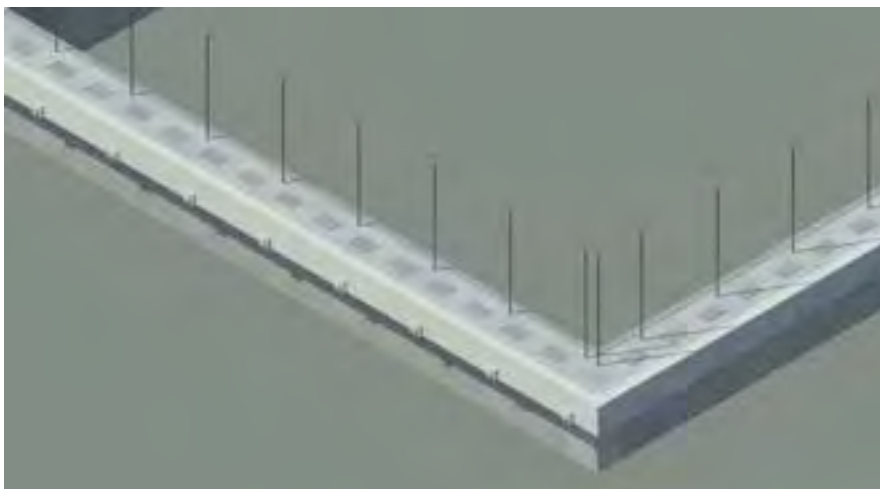

Brick ledge and stem wall are finished, and now the interior slab base can be filled and compacted and termite treated, and the slab can be poured.

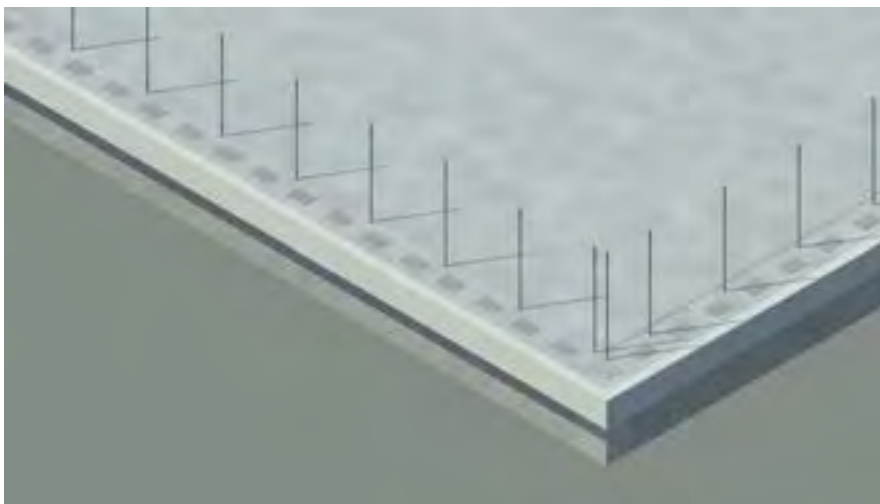

With the slab poured, the exterior walls can begin to be constructed.

## **FOUNDATION CONSTRUCTION**

### **Creating a Brick Ledge (cont.)**

The rendering below shows a 3D view of the finished brick ledge and the first two courses of block installed with the poured slab.

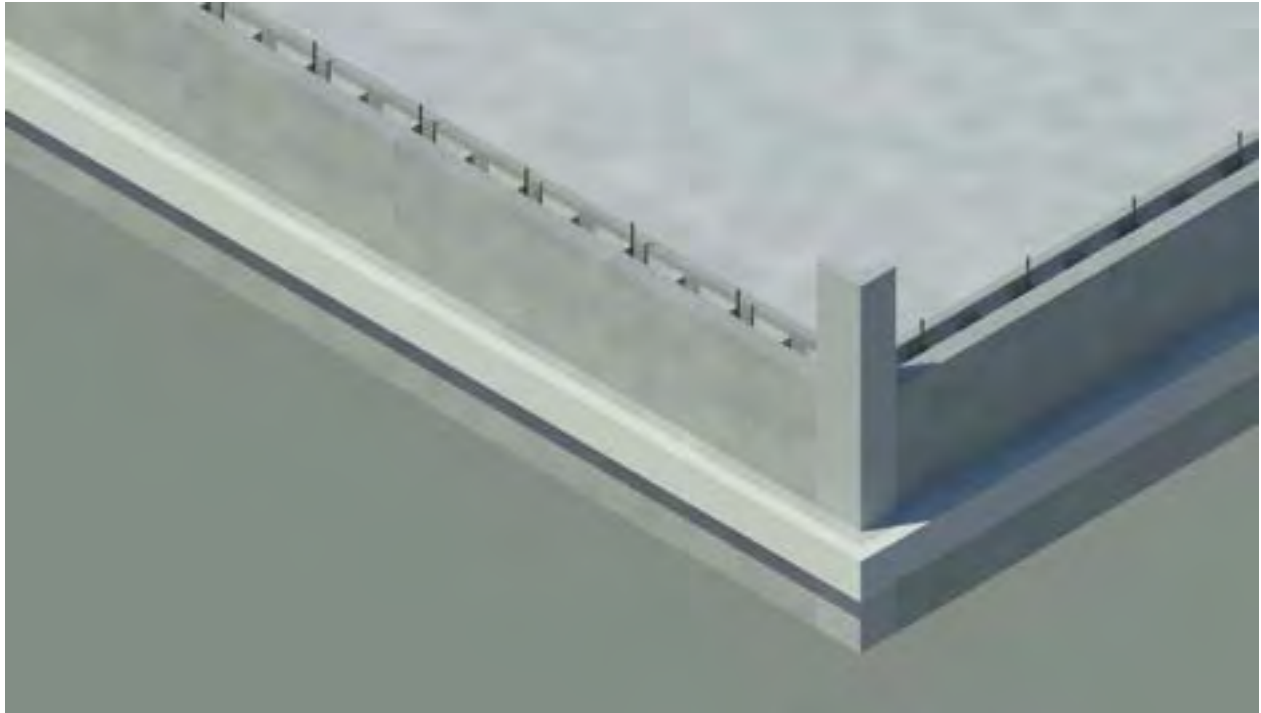

## FOUNDATION CONSTRUCTION

### Creating a Brick Ledge (cont.)

Added  
9/21/21

The detail below shows a section view of the attached brick ledge before concrete is poured to the finished floor level and the stem wall is backfilled and the floor slab base is prepared. The brick ledge can be placed at an elevation below the finished floor elevation if desired. If so, cut flow holes instead of flow channels, where the top of the flow hole is even with the top of the top of the brick ledge.

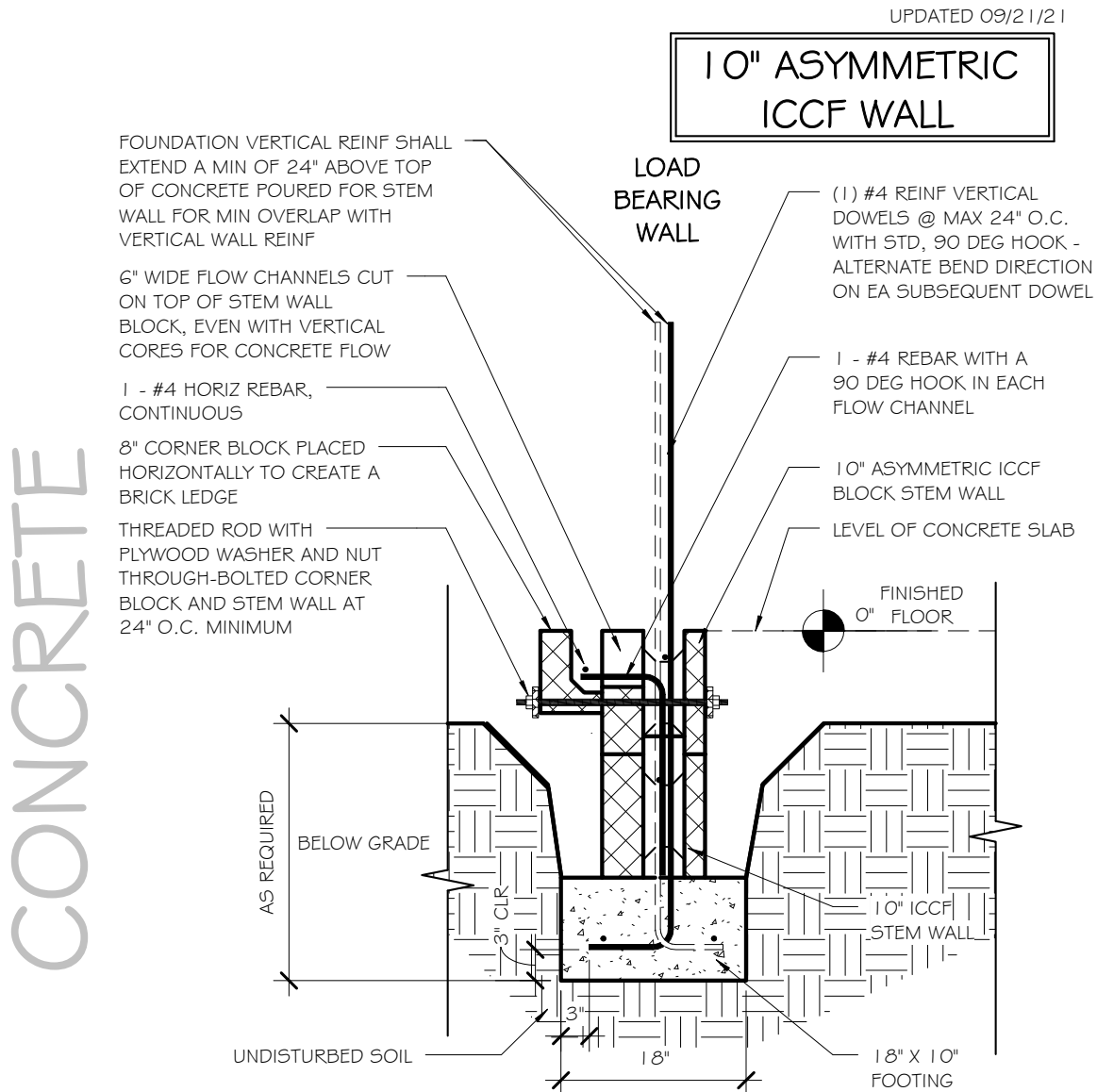

## BRICK LEDGE W/ 10" ICCF STEM WALL

SCALE: 3/4" = 1'-0"

## FOUNDATION CONSTRUCTION

### Waterproofing - Below Grade

#### Basement Wall and Stem Wall Waterproofing

What are the best solutions to treat the exterior for waterproofing below grade applications including retaining walls?

#### Basement Wall Waterproofing ICCF

Like any building material used below grade for a dry basement, ICCF must be waterproofed. The waterproofing method we suggest is to apply a waterproofing coating, such as Hydroguard (black) or Rub-R-Wall (aqua green) or several other available waterproofing coatings on the below grade ICCF wall. If desired, a parge coat (a thin skim coat of stucco) applied to the wall prior to coating the wall, can reduce the consumption of waterproofing on the highly textured ICCF wall). In addition, a French drain at the footing is essential to remove water in the surrounding soil, to a sump and pump well away from the house or drain to daylight if you have a sloped yard. Then roll out and apply a water impermeable plastic sheet of dimple board around the basement wall to direct water to the French drain to remove water, reduce water pressure against wall and prevent water passing through the basement wall.

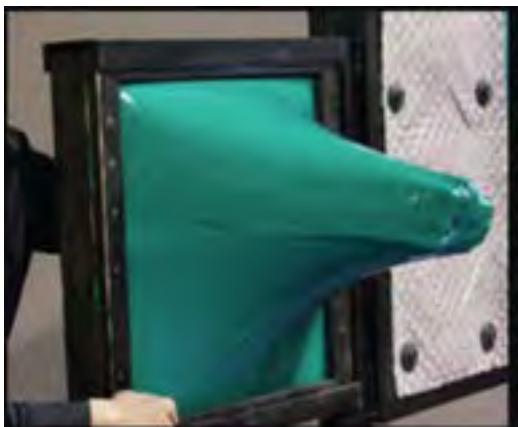

## FOUNDATION CONSTRUCTION

### Waterproofing - Below Grade

#### Basement Wall and Stem Wall Waterproofing (Cont.)

Along with the previous methods, use gutters to prevent rainwater from saturating the backfill around the basement wall and increasing water pressure in the soil or overwhelming the French drain. Ensure there is, at a minimum, a negative 5% slope in the grade around your house to prevent surface puddling of water against your basement wall that can seep down through your backfill. Follow these guidelines for any basement wall and your basement will likely remain dry.

#### Stem Wall Waterproofing

ICCF Stem wall foundations that do not have a living space behind them or a crawl space, only a waterproofing layer on the block face is suggested to minimize the ICCF wall from absorbing moisture from the surrounding soil. Like an ICCF basement wall, the waterproofing method we suggest is to apply a waterproofing coating, such as Hydroguard (black) or Rub-R-Wall (aqua green) or several other available waterproofing coatings on the below grade ICCF wall.



## WALL CONSTRUCTION

### Wall Layout

Once the foundation has been completed and ideally after the floor slab has been poured, the ICCF wall construction can begin.

**Builder's Tip:** We are builders as well as a manufacturer of ICCF, and we will not work on dirt when we build ICCF walls. Besides the obvious safety issues that dirt floors can compromise, the simplicity and downright "pleasure" it is to work on a safe, hard and flat concrete surface, with few trip hazards justifies our hard line about working on dirt. [Of course there are exceptions: Building ICCF stem walls and crawl spaces come to mind. But, if you have to work on dirt, or you want to, then grade your dirt floor well and work slow and safe.]

Wall construction must start at wall layout. Wall layout begins with a measured and squared chalk line diagram marked on the foundation and/or slab that you will use to properly align and set **the interior face** of your first course of EBS block. From the exterior edge of the foundation or slab, snap a parallel chalk line that is offset the thickness of the ICCF blocks chosen for your exterior wall (Example: For 8" block thickness; For 10" block thickness). Placing the interior face of the block wall aligned with this chalk line will align the exterior face of the wall exterior face of the stem wall foundation or slab. See Figure 7.1., and Photo 7.1., page 7.1.1.

Changed  
6/04/22

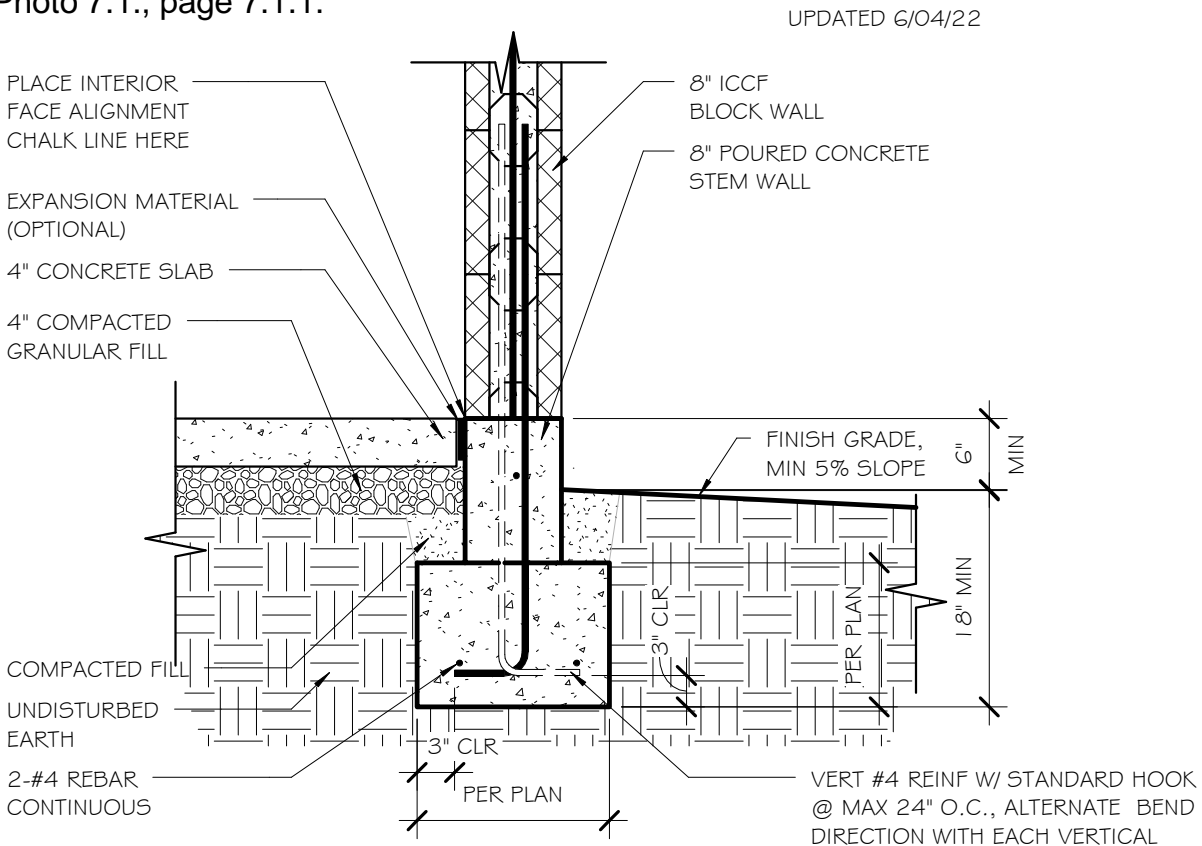

Figure 7.1

## ICCF BLOCK FIRST COURSE PLACEMENT

SCALE: 3/4" = 1'-0"



## WALL CONSTRUCTION

### Beginning Wall Layout and Block Placement



For a 10" block, measure 10" (9 1/2" for exterior offset) from the edge of the stem wall for placement of the first block of the first course of a wall.

Note: 10" Stem wall and poured slab. Two vertical rebar dowels at the corner, 4" apart. Then rebar dowels at 24" on center from the second rebar dowel to next corner. Working clockwise, and starting at any corner, marking the 10" (9 1/2" for exterior offset) offset for the footprint of the 10" corner block to be placed vertically. See Figure 7.2, page 7.2.

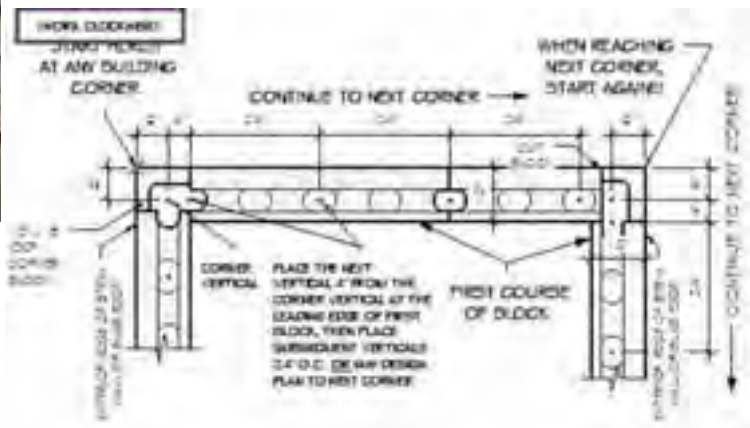

When all the block has been placed for a wall except the very last one, cut the last block to the exact dimension of the wall termination line which would be 8" (7 1/2" for exterior offset) from the edge of the stem wall to accommodate the 8" side of a 10" corner block. To start the next wall, the procedure is identical to the first. See Figure 7.2, page 7.2.

## WALL CONSTRUCTION

### Beginning Wall Layout and Block Placement (cont.)



Photo 7.1

When using 10" EBS blocks - The red chalk line is placed 9 1/2" (for 1/2" offset) from the exterior face of the stem wall or foundation, align the interior face of the block wall with this line. This alignment will provide the exterior wall with a minimum 1/2" drip edge over the foundation. See Figure 7.2, page 7.2.



Photo 7.2

When using 10" EBS blocks - Offset the first block of the first course 10" (9 1/2" for exterior offset) to allow for the EBS corner block placement. See Figure 7.2, page 7.2.



Photo 7.3

Place subsequent blocks over the foundation vertical rebar adjusting vertical rebar as necessary to center the rebar in the block cores as not to interfere with the blocks when adjusting the wall alignment.



Photo 7.4

Take care to "plumb and level" each block. Maintain straight wall alignment with a long straightedge, level or string.



Photo 7.5

Plumb and level using shims.

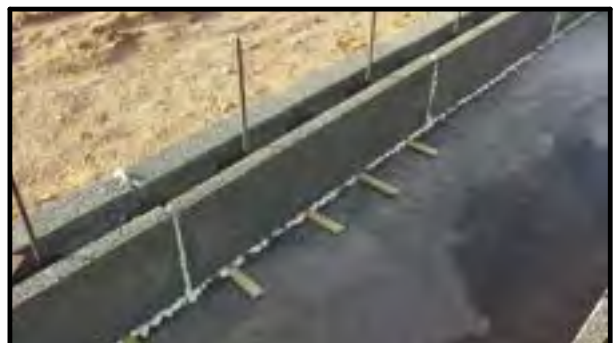

Photo 7.6a

Plumb and level and polyurethane foam glue in place. Take great care not to move the block when tacking block in place.

## Gluing Block and Corner Preparation



Photo 7.6a  
Tack gluing (every 12") of the first course.



Photo 7.6b  
Tack gluing, both sides.



Photo 7.6c  
Plumb and level and polyurethane foam adhesive in place. Take great care not to move the block when tacking block in place. 15 to 20 minutes later, when the tack gluing dries, you can "super glue" (glue every 3-4") the block.



Photo 7.1

**NOTE: When gluing, foam adhesive outside the glue joint is waste. Release the trigger on the glue gun when adhesive starts to come out of the joint.**



Photo 7.8  
The second course placed, plumbed, leveled, and glued. (10" Asymmetric Block pictured)

Photo 7.7  
For 8" Block: When the first course terminates at the beginning of the next corner, cut the last block to align 6" (5 1/2" for exterior offset) from the exterior face of the stem wall or foundation to allow for the 6" side of an 8" corner block's footprint of the EBS corner block placed vertically. Place at least 2 courses of block, then place a corner block. See Figure 7.2, page 7.2.



Photo 7.9  
Interior Corner, 10" Asymmetric ICCF



Photo 7.10  
Exterior Corner, 10" Asymmetric ICCF

As the manufacturer of The Perfect Block ICCF blocks we have compiled manufacturer's specifications notes that we include in the "Construction Notes" sheet of the construction documents that we submit to jurisdictions when we are contracted to do a "design/build" project. The following notes are typical of our specifications and may be relevant to your design project.

## INSULATED COMPOSITE CONCRETE FORM (ICCF) NOTES

UPDATED 8/02/20

INSULATED COMPOSITE CONCRETE FORM WALL CONSTRUCTION CONFORMS TO CHAPTER 6, EXTERIOR CONCRETE WALL SYSTEM, SCREEN-GRID WALL SYSTEM IN THE CURRENT INTERNATIONAL RESIDENTIAL CODE (IRC).

ICCF WALL BLOCKS MAY BE INSTALLED IN A VERTICAL OR HORIZ POSITION WITH VERT AND HORIZ CORE CAVITIES ALIGNED AND REINFORCEMENT INSTALLED IAW IRC AND/OR MANUFACTURER'S INSTRUCTIONS AND/OR ENGINEERING REQUIREMENTS.

WALLS MUST BE ADEQUATELY BRACED TO RESIST LATERAL FORCES PRIOR TO AND DURING CONCRETE GROUTING.

### **CONCRETE MATERIAL**

ICCF VERTICAL AND HORIZ CORES SHALL BE GROUTED SOLID.

READY-MIX CONCRETE FOR ICCF WALLS SHALL BE IAW IRC SECTION 402.2.

VIBRATION OF WALL GROUT IS NOT REQUIRED.

CONCRETE SHALL HAVE A MINIMUM SPECIFIED COMPRESSIVE STRENGTH OF 3000 PSI AT 28 DAYS.

CONCRETE SLUMP OF 8 - 10 INCHES IS PREFERRED FOR ADEQUATE CONCRETE FLOW. THE USE OF CONCRETE FLOW ENHANCER ADDITIVES IS ENCOURAGED.

MAXIMUM AGGREGATE SIZE SHALL NOT BE LARGER THAN 3/8".

### **REINFORCING STEEL**

MINIMUM YIELD STRENGTH OF REINFORCING STEEL SHALL BE 40,000 PSI (GRADE 40).

HORIZ REINFORCEMENT SHALL BE CONTINUOUS AROUND BUILDING CORNERS USING CORNER BARS OR BY BENDING THE BARS. MINIMUM LAP SPLICE SHALL BE 24" FOR 1/2" DIAMETER REINFORCEMENT, 30" FOR 5/8" DIAMETER REINFORCEMENT. WIRE TYING LAPPED REINF IS NOT REQUIRED.

## INSULATED CONCRETE FORM NOTES

### (cont.)

#### REINFORCING STEEL (CONT.)

WHERE LAP SPLICING OF VERTICAL OR HORIZ REINFORCING STEEL IS NECESSARY, THE LAP SPLICE SHALL BE A MINIMUM OF 24" FOR 1/2" DIAMETER REINFORCEMENT, 30" FOR 5/8" DIAMETER REINFORCEMENT.

HORIZ REINFORCEMENT MAY BE PLACED ON BOTTOM OF ICCF HORIZ CORE WITH NO NEED FOR ELEVATION FOR CONCRETE COVERAGE.

VERTICAL REINFORCEMENT INTERVAL IS PLACED IN ACCORDANCE WITH THE APPROVED BUILDING PLANS.

THE MAXIMUM DISTANCE BETWEEN NON-CONTACT PARALLEL BARS AT A LAP SPLICE SHALL NOT EXCEED 8 DIAMETERS.

PLACE 2 VERTICAL REINFORCEMENT IN CORRESPONDING VERTICAL WALL CORE AT EACH GIRDER TRUSS OR BEAM SUPPORT POSITION ON AN ICCF WALL.

#### WALL OPENINGS

REINFORCEMENT PLACED HORIZONTALLY ABOVE AND BELOW AN OPENING SHALL EXTEND A MINIMUM OF 24" ON EACH SIDE, BEYOND THE LIMITS OF THE OPENING.

THE PERIMETER OF ALL WALL OPENINGS SHALL BE FRAMED OR "BUCKED" SUFFICIENTLY TO PREVENT THE FLOW OF GROUT CONCRETE INTO THE OPENING DURING CONCRETE POUR.

PLACE VERTICAL REINFORCEMENT WITHIN A MAXIMUM OF 1 2" FROM EACH VERTICAL EDGE OF WALL OPENING.

## WALL CONSTRUCTION

### Wall Layout (Cont.)

**Builder's Tip:** Use red chalk snap lines. Red chalk seems to make a more resilient mark than blue chalk and spraying chalk lines on a concrete slab with a can of cheap hair spray can make the lines last longer under most common construction site wear and tear.

**Marking the Corners:** (Note: the following text describes the method of block placement to create a "natural drip edge" which is not a building requirement, if you choose not to do this then just use the full block widths) See Figure 7.2 for this description. For marking corners to start each block wall that ends with a 90-degree corner, three lines must be placed for an accurately built wall. As described in Wall Layout on the previous page, the "(A) interior wall face alignment lines" are placed matching the thickness of the wall block being used, minus 1/2", this interior wall face line will be your alignment line for the interior face of all the blocks of your first course. Now is the time to mark your corners. Working clockwise, from the edge of the stem wall or slab, measure a distance aligned with your wall that is offset -1/2" of the thickness of the EBS blocks chosen for your exterior wall (Example: For 8" block thickness, offset 7 1/2"; For 10" block thickness, offset 9 1/2"). Make a perpendicular line to your interior wall face alignment line at this distance. This mark is your start point for each first block of each wall. These "(B) wall block start lines" will be where you place the "factory" end edge of your first course block for the start of each block wall (these lines should coincide with your interior wall face alignment lines). This measurement ensures that when the corner blocks are installed after completion of all the walls the corner blocks will have the same "overhang" of the stem wall or slab that your full blocks have, creating a natural "drip edge".

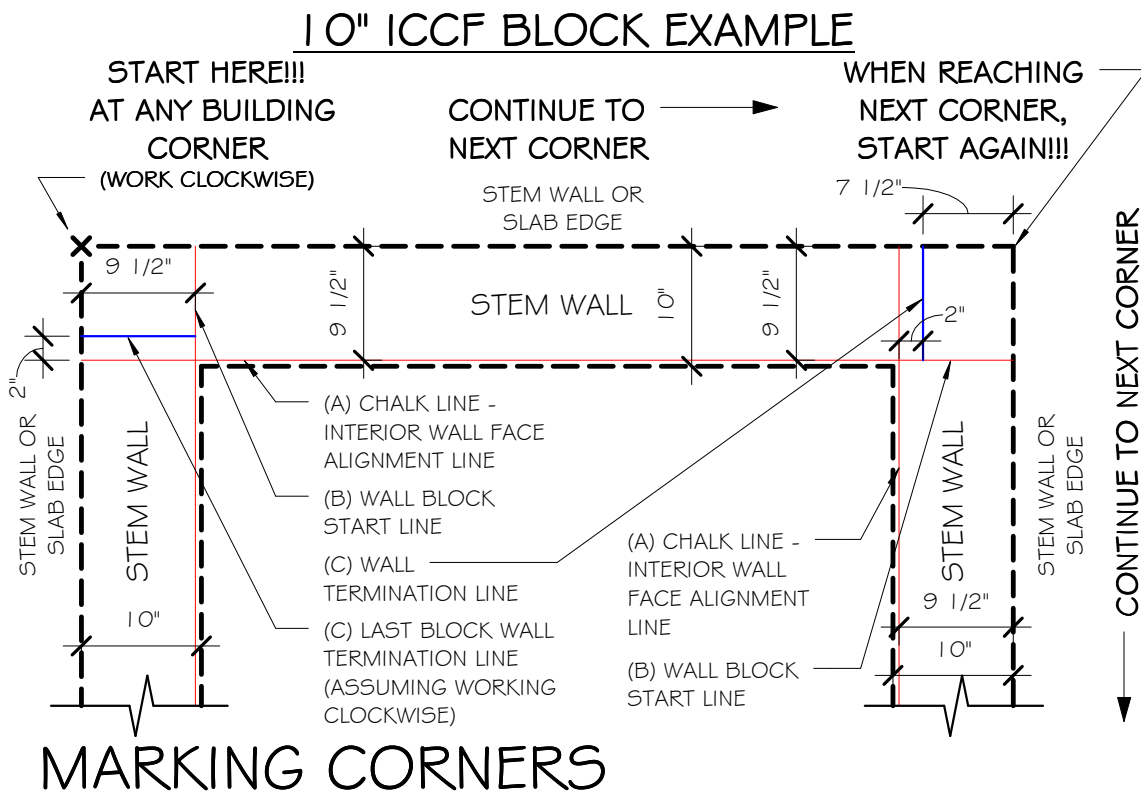

SCALE: 3/4" = 1'-0"

Figure 7.2

## WALL CONSTRUCTION

### Wall Layout (Cont.)

The last line needed to mark a wall is a "(C) wall termination line". From the edge of the stem wall or slab where the wall will terminate and turn 90 degrees, measure a distance aligned with your wall that is offset minus 2-1/2" of the thickness of the ICCF blocks chosen for your exterior wall (Example: For 8" block thickness, offset 5 1/2"; For 10" block thickness, offset 7 1/2"). Make a perpendicular line to your interior wall face alignment line at this distance. This mark is your termination point for the last block of each wall. These "(C) wall termination lines" will be where you measure and cut your last block of each course of each block wall. This measurement will ensure, like the previous offset that when the corner blocks are installed after completion of all the walls, that both edges of the corner blocks will have the same "overhang" of the stem wall or slab that your full blocks have, creating a natural "drip edge".

### Creating Door and Window Openings

Creating door and window openings is as simple as cutting an ICCF block to length to your layout line for your openings and setting the cut block.

**Builder's Tip:** It's critical to know what your "rough opening" dimensions will be for the type of window or door you will install in your building. An additional factor that will affect your rough opening dimensions is the method or type of opening "buck" you will use. "Bucks" are the framing within an opening that support the lintel and hold back fluid concrete during grouting. There are countless methods to "buck" an opening including using end elements to frame an opening. Suggested methods will be described later.

**Marking door openings:** After placing block alignment and corner lines, mark and label the location of the door rough openings with "magic marker" (permanent marker makes more persistent lines) on the stem wall or slab. In addition, also mark the layout for any intersecting EBS interior walls. It is much easier to build intersecting block interior walls with each perimeter course so block cuts and tie-in rebar can be placed with little effort as the wall courses go up. (Marking window rough openings will come later after placing the third course of block.)

**Important Note:** When cutting to length and placing blocks for each side of door or window openings, the block vertical core alignment must be maintained (12" on center) across the opening to the other side of the opening to ensure vertical core alignment for the block lintels above the openings and the foundation vertical rebar on the other side of the opening. An easy way to visualize this is to think of building your course by placing full block across a marked opening and then cutting and removing the piece in between thus ensuring the 12" on center core alignment of the block on the other side of the opening. Of course, we do not suggest that you actually build like this because it would generate more waste than necessary. Use a full block set to the side as a guide.

## WALL CONSTRUCTION

### Creating Door and Window Openings (Cont.)

**Builder's Tip:** If 2x wood bucks are used to "buck" openings in the block core flush with the rough opening: A technique for getting smooth RO cuts after grouting: Cut the block approximately 1" or more longer so the cut end of the block extends into the rough opening. When the bucks are precisely placed and secured to the exact rough opening dimensions this leaves extended block material beyond the bucks for better gluing and added strength before the grout pour. After the grout pour, using the bucks as a saw guide, an electric chain saw can cleanly cut the extended block flush with the bucks.

### Staging Materials and Preparing a Work Area

Placement of stacks of EBS blocks, materials and tools, and locating the general work area inside the perimeter of the wall on the finished slab will make wall assembly and concrete placement easier and safer. Tools and materials required to construct buildings using EBS blocks are those hand and power tools used in work associated with ordinary carpentry, concrete, and reinforcing steel installations. Only a few specialized tools are needed. A list of recommended tools can be found in Recommended Tools and Supplies (Page 4.2). Owning your own pallet jack is always a plus.

**Builder's Tip:** Before we begin to build on a slab, we place 5 gal buckets (preferably orange buckets) over any under-slab rough-in plumbing or electrical stubs that stick out of the slab to hopefully prevent an inadvertent trip or fall over an obstacle that will likely be present on any slab-on-grade project.

Added  
6/04/22

We recommend staging your bundled rebar not on your slab but outside of your perimeter near an opening for easy access. Prepare a place near your rebar bundle for easy measuring, cutting and bending rebar. If you are using a circular saw and metal cutting blade to cut rebar, saw horses to raise the rebar make measuring and cutting rebar less of a bending or kneeling chore.

### Setting The First Course Of Blocks

EBS blocks may be installed horizontally or vertically. EBS believes that installing EBS blocks horizontally is the fastest and most efficient way to erect straight walls. Vertical block installation should be used for special applications such as curved walls or used as "rippers" in places requiring a short block length (under 12", the height of a block) to avoid multiple cuts. A ripper placed vertically will cover 4 courses of height, avoiding cutting four short block. Horizontal installation will be described here and vertical installation will be described later.

See Figure 7.2 on page 7.2. Horizontal placement of the first course of EBS blocks should begin at a corner. Build in one direction only (clockwise is recommended) until approaching the next corner. Place the first block over the foundation vertical rebar and align with the block's vertical cores and position the end of the first block at the "(B) wall block start line". Ensure that the interior face of the blocks of this first course are set along your chalk line "(A) interior wall face alignment line" and take care to plumb each block **and** level each block with the previous placed block. With a six foot or longer level or straightedge, ensure a straight wall alignment from one block to the next.

## WALL CONSTRUCTION

### Setting the First Course of Blocks (Cont.)

Shim to plumb and level if needed and liberally glue each block in place to the foundation or slab and each previous block. Be careful not to move aligned and plumb blocks while gluing.

### Setting the Last Block of the First Wall

Cut the last block of the wall to align with the (C) wall termination line you placed for this wall. Start the next wall at this corner as the previous corner and continue the next wall in the same direction and repeat for each subsequent wall. When the first course is complete, mark locations of any other significant wall features (utility penetrations, beam pockets, etc.) with a magic marker on the inside side of the first course at this time.

### Setting Second Course and Subsequent Courses of Block

Build one course at a time and before setting the next course of block, place all the horizontal rebar and corner rebar with the proper lap splice lengths in the top horizontal core of each course or as specified by code or your design plan.

Vertical rebar will be placed in the vertical wall cores from the top of the wall when all courses are complete. For multi-story buildings, the vertical rebar must also be provided with the proper lap splice by code as the horizontal rebar. Placement of the second course of block and subsequent courses should be identical to the first course.

Be sure to use a level placed at the end edge of the start and end blocks of each of the following courses to ensure that the ends of each wall are plumb and aligned with the first course blocks and all other course blocks below it. Stack blocks identical in length to the block below. Shim each block if necessary to level and plumb the interior face of the wall. Glue each set block to the block below and the previous set block.

**Important Note:** When building with EBS Block, stacking block in a "running bond" pattern like brick or cinder block (concrete masonry unit (CMU)) for additional strength is not necessary. The strength of an EBS wall comes from the cured reinforced concrete (grout) within the EBS Block wall. A "stack" bond is what we prefer to use to construct ICCF walls. A stack bond is placing a block directly over a block below without a halfway offset. This allows you when laying block, and you come up to an opening, you can make identical cuts in the vertical stack of block in each course. This minimizes measuring and cutting blocks to different lengths saving time and labor over a "running bond" stack and does not affect wall strength. If you prefer a running bond, there is no harm if you choose to stack in a "running bond."

### Gluing Technique with Spray Foam Adhesive

**Builder's Tip: Gluing technique with spray foam adhesive:** This is a recommended EBS construction technique and not necessarily the only way to glue block. When gluing block, take care while pressing the glue gun tip into block joints, not to misalign the block you just spent precious time and effort to level and plumb. One method to gluing is, with a hand on the top of the block adding pressure, gently tack (about every 12") in the line

## WALL CONSTRUCTION

### Gluing Technique with Spray Foam Adhesive (cont.)

between blocks with a wrist twist of the glue gun, so the tip penetrates approximately 1/2" without moving the block and with the bottle upright, squeeze a quick trigger squeeze in a few key places and allow the glue to set while you prepare and set the next blocks. In fifteen to twenty minutes when the adhesive has set, and so you will not misalign a plumb block, you can come back to the tacked block and jab the gun tip in without a twist and tack glue liberally on each side of block every 5" to 6". Laying a bead of glue as if it were mortar, is a mistake and a very wasteful gluing technique. (See Gluing Technique video link below)

The link below is a YouTube video illustrating our recommended gluing technique:

<https://www.youtube.com/watch?v=ZxzHsS9K5vY>

### Builder's Tip: Gluing Consumption and Technique Blog Added:

#### **How Much Adhesive Do I Need for My ICCF Project? How do I estimate consumption?**

We suggest you use our method of gluing, described in the EBS Technical Construction Manual, and not the long bead method seen used by some on YouTube. The adhesive saved will be tremendous.

Everyone's gluing technique can vary from one person to the next. To determine adhesive consumption for your project, our recommendation is to order one box of 12 cans of adhesive from Amazon (Amazon links below) or others. Then remove and use 6 cans for your initial block placement. When the 6 cans are empty, determine the number of block courses or the wall square footage that the first 6 cans of adhesive covered.

Once your consumption is determined by wall courses or wall square feet. Then calculate the remaining courses or wall square footage for your project. From that remaining square footage number, you can estimate the total cases or cans of adhesive to order for the rest of the build before you run out of the first box. This method can save you from running short during building and save you from ordering too much or too little foam adhesive for the job.

Amazon links for ordering foam adhesive and cleaner (you only need one can of cleaner):

[https://www.amazon.com/Enerfoam-30oz-Sealant-Polyurethane-Insulation/dp/B091MLX4G2/ref=sr\\_1\\_1?crid=2G0FMHAJ6GM07&keywords=enerfoam%2Bby%2Bdow&qid=1696440675&srefix=ener%2Bfoam%2Bby%2Bdow%2Cspecialty-aps%2C511&sr=8-1&th=1](https://www.amazon.com/Enerfoam-30oz-Sealant-Polyurethane-Insulation/dp/B091MLX4G2/ref=sr_1_1?crid=2G0FMHAJ6GM07&keywords=enerfoam%2Bby%2Bdow&qid=1696440675&srefix=ener%2Bfoam%2Bby%2Bdow%2Cspecialty-aps%2C511&sr=8-1&th=1)

Amazon links for ordering foam adhesive and cleaner (you only need one can of cleaner): Continued.

[https://www.amazon.com/GREAT-STUFF-PRO-Construction-Adhesive/dp/B0044UV358/ref=sr\\_1\\_5?crid=BV3KDVVJ59BK&keywords=great%2Bstuff%2Bprofessional%2BAdhesive&qid=1696440898&srefix=great%2Bstuff%2Bprofessional%2BAdhesive%2Caps%2C133&sr=8-5&th=1](https://www.amazon.com/GREAT-STUFF-PRO-Construction-Adhesive/dp/B0044UV358/ref=sr_1_5?crid=BV3KDVVJ59BK&keywords=great%2Bstuff%2Bprofessional%2BAdhesive&qid=1696440898&srefix=great%2Bstuff%2Bprofessional%2BAdhesive%2Caps%2C133&sr=8-5&th=1)

[https://www.amazon.com/Great-Stuff-Foam-Cleaner-12oz/dp/B0BFTTPDYJ/ref=sr\\_1\\_7?crid=2RF43J7S8SW3L&keywords=foam+adhesive+cleaner&qid=1696441567&srefix=foam+adhesive+cleaner%2Caps%2C160&sr=8-7](https://www.amazon.com/Great-Stuff-Foam-Cleaner-12oz/dp/B0BFTTPDYJ/ref=sr_1_7?crid=2RF43J7S8SW3L&keywords=foam+adhesive+cleaner&qid=1696441567&srefix=foam+adhesive+cleaner%2Caps%2C160&sr=8-7)

Remember to use the adhesive as suggested. Do not pour/squeeze a bead of adhesive on the top of the block mating surfaces between block as if it were mortar and drop a block on top (Some YouTube videos, not made by us, suggest to pour beads this way - This is not recommended by us). This makes a very poor, flat glue joint and can consume as many as 20 to 30 times the adhesive needed to tack the forms in-place.

**Don't use this gluing technique! It makes a poor joint and is tremendously wasteful!**



**How Much Adhesive Do I Need for My ICCF Project? How do I estimate consumption? Cont.**

The recommended method is to dry stack the block, align and plumb the block using shims if needed, then tack the block together at the seams between blocks, horizontally and vertically, with a 1/2" of penetration of the gun nozzle and a quick trigger squeeze every 5" to 6" (please see the above YouTube link to our glue technique video). This delivers adhesive under pressure and fingers of adhesive reach up and down into each block and creates an excellent bond between block, with very little adhesive consumed. If foam comes out of the joint, release the trigger (the gun can adjust the adhesive delivery flow). Foam adhesive outside of the joint is waste and does not help secure the block. Glue both sides of the blocks.

Also, think of the foam adhesive as being cheap insurance to keep every block secure and in place and plumb and level until grouting. So, don't use it sparingly, but don't waste it either.

## WALL CONSTRUCTION

This is a continuation of the sequential construction pictorial for the small house on pages 6.4b - 6.4f.

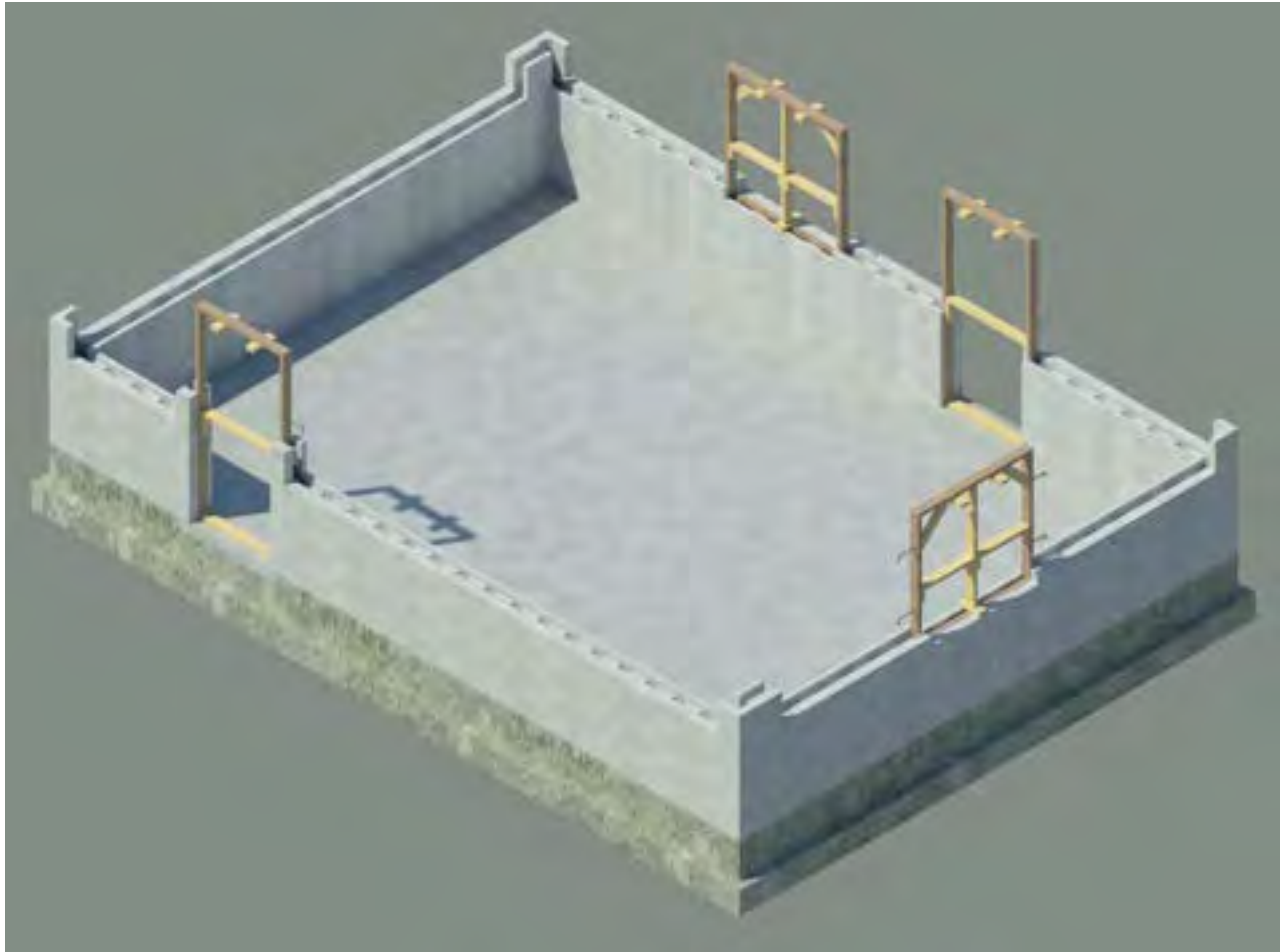

After placing the third course, the third course is a good place to begin to set the door and window bucks. Note that the 4040 window sill is at 32", and the top of the third course block must be cut down 4" to have the door and window head heights align.



## **WALL CONSTRUCTION**

The fourth course is placed and the 3030 window for placement over the kitchen sink is set at a sill height of 44".

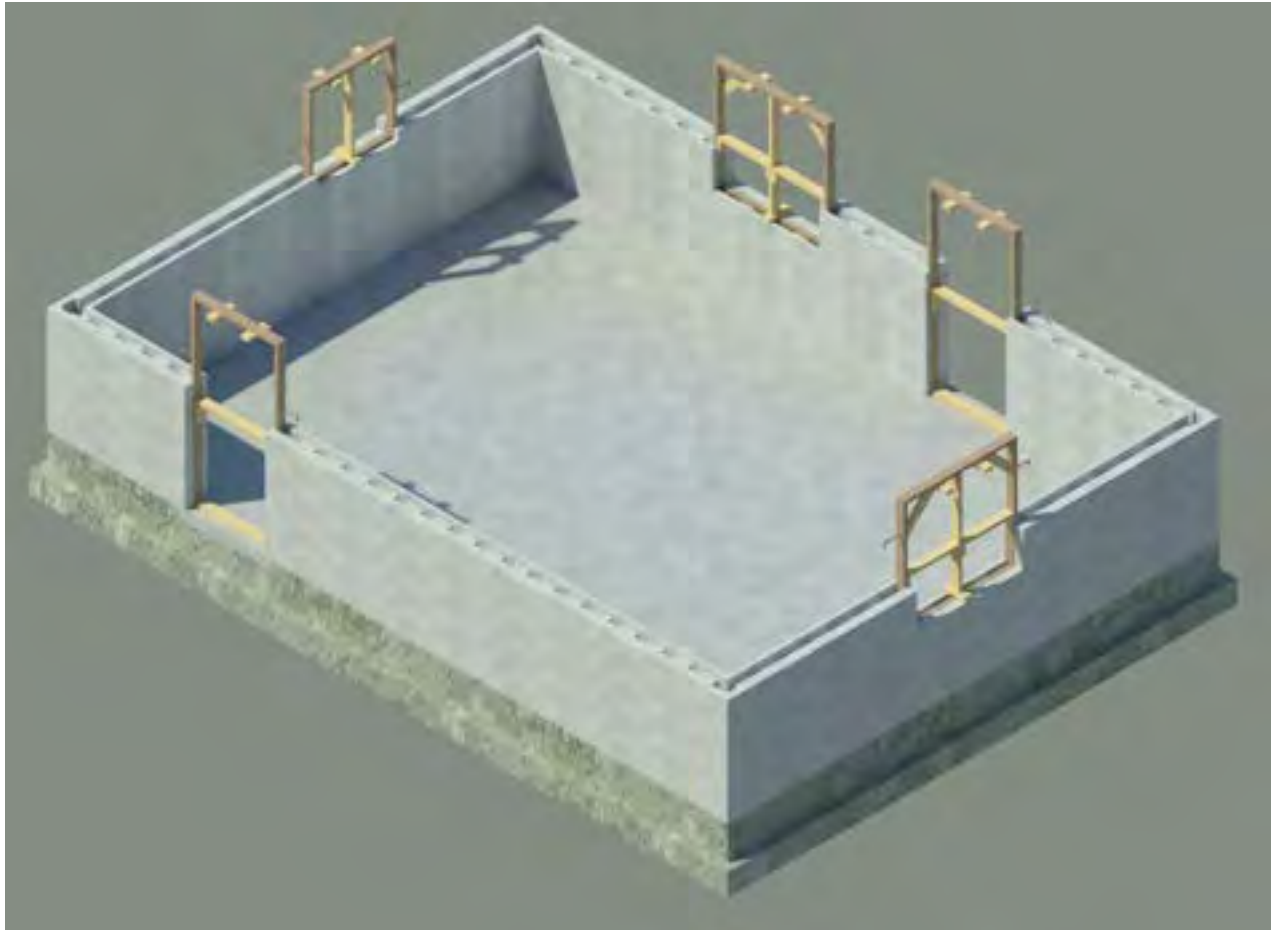

## WALL CONSTRUCTION

The fifth and sixth courses are placed. Note the two foot long 6" wide rippers on each side of the kitchen window.

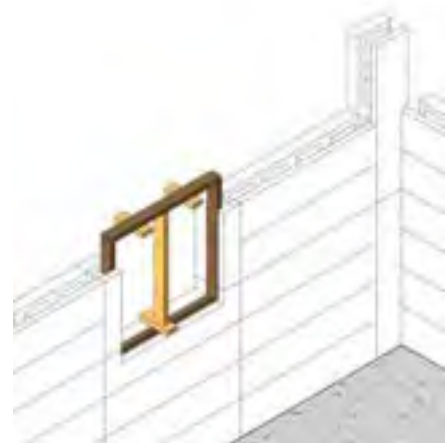
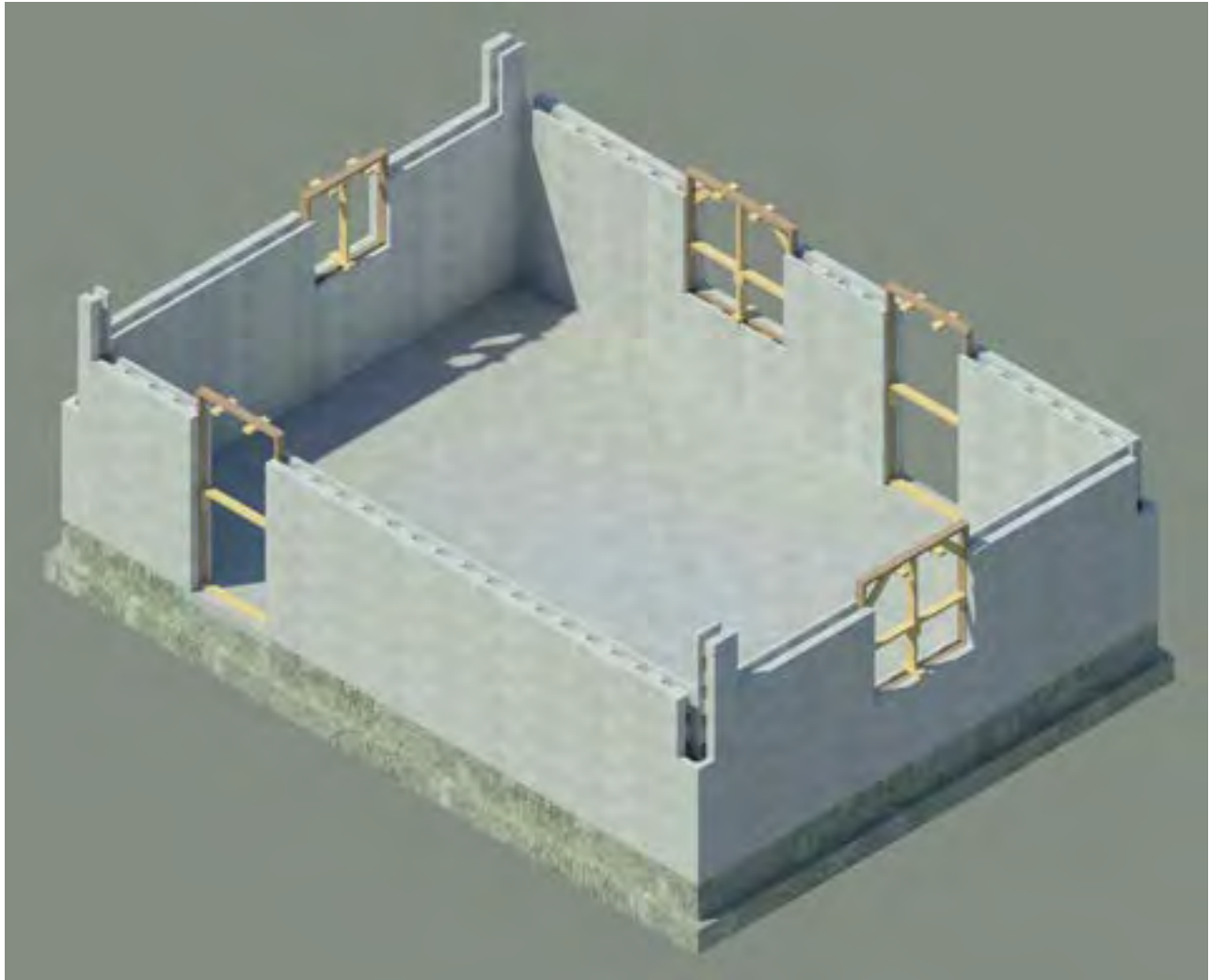

## WALL CONSTRUCTION

The seventh course is placed, and 4 more 10" corner blocks are placed vertically at the building corners.

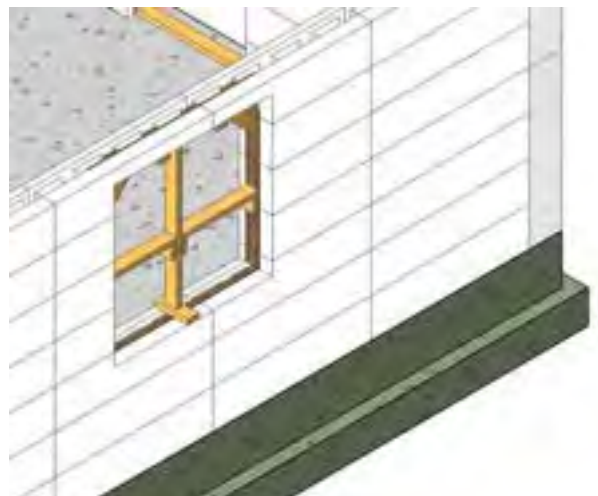
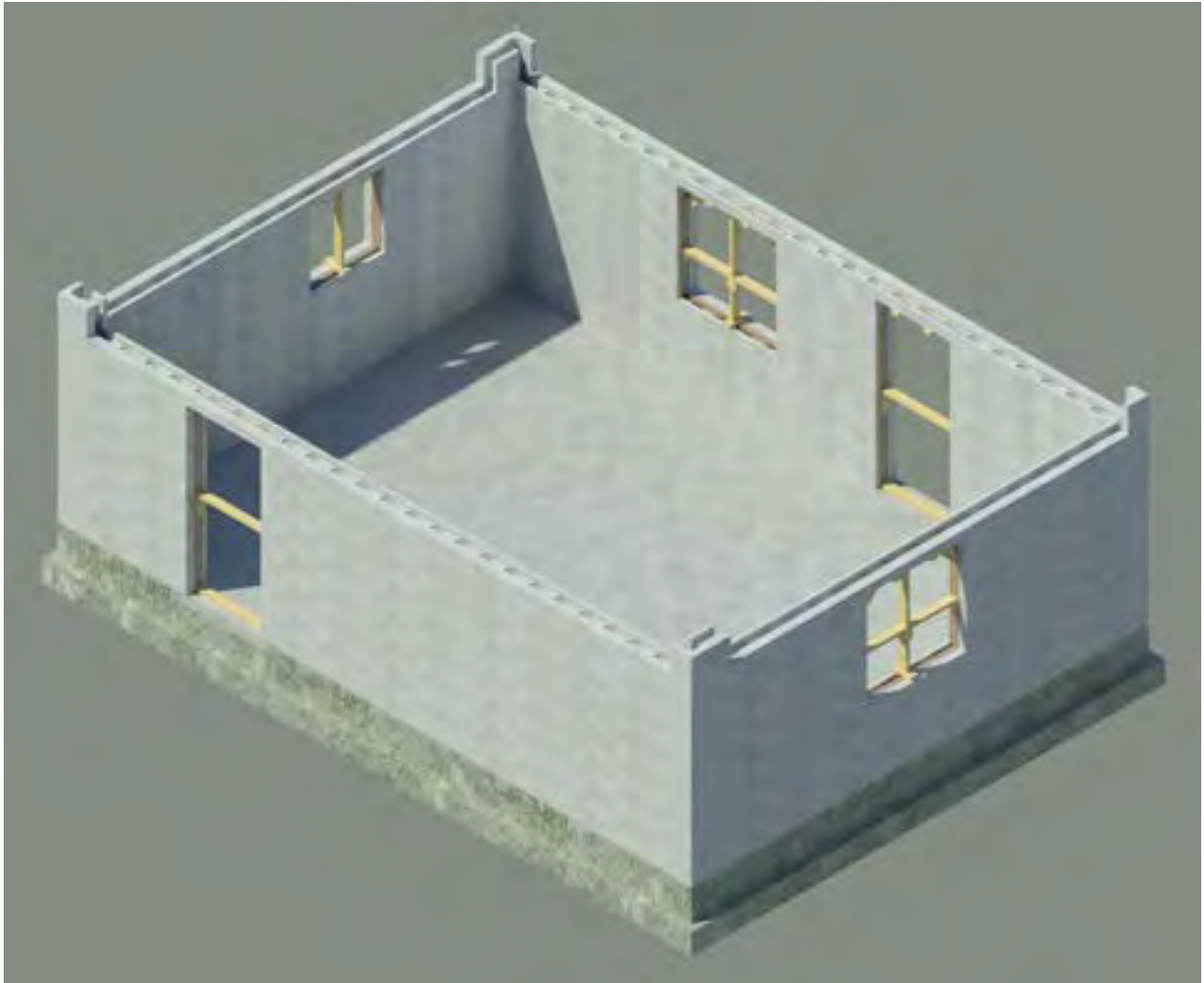

## WALL CONSTRUCTION

The eighth and ninth courses are placed. The top plate height is 9' 0" plus 1 ½" for the thickness of a single 2x10 top plate, from the finished floor. Four 1' pieces of 10" corner block need to be placed and then the walls will be complete and ready to drop the vertical rebar in from the top course at the proper design interval, and then grout. After grouting and while the concrete is fluid, anchor bolts are placed @ 36" on center or IAW design requirements.

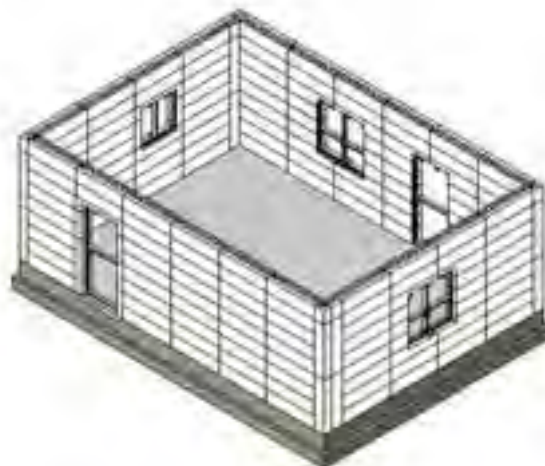
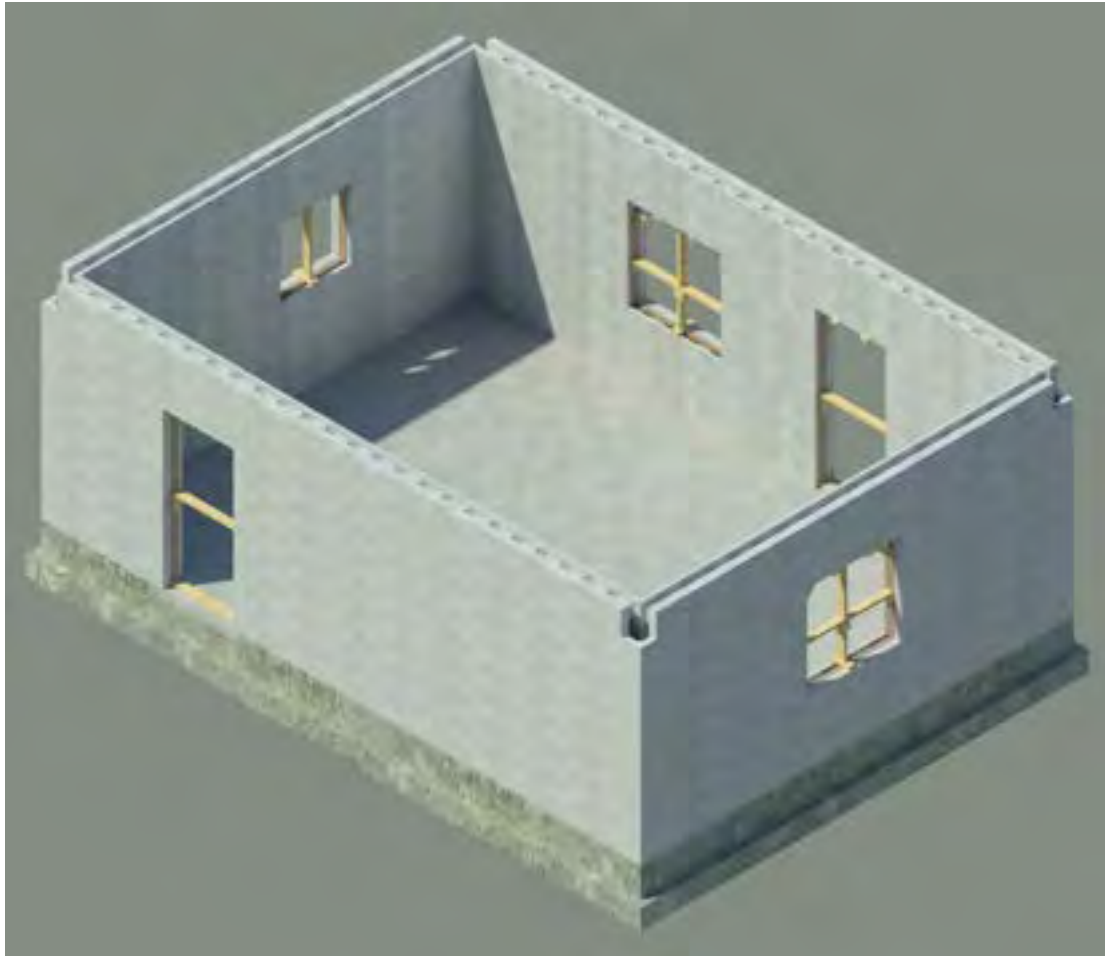

## **WALL CONSTRUCTION**

The building walls are complete to nine courses, 9' 1 1/2" height of wall, and fully grouted with anchor bolts in place at 36" on center. The anchor bolts are set to receive a single thickness 2x10 with miter cuts at the corners. Typically the inside edge of the 2x10 top plate is aligned with the interior face of the wall.

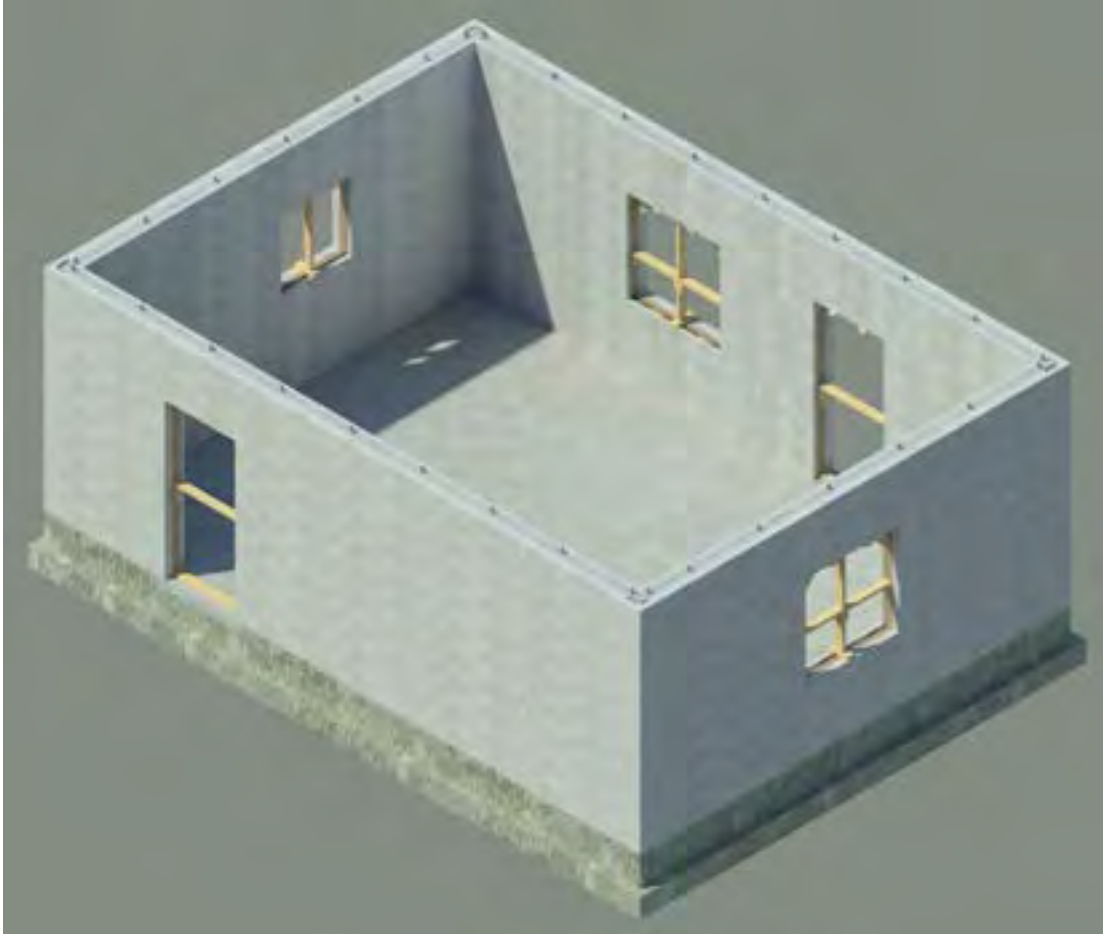

## WALL CONSTRUCTION

Now that the walls are complete and grouted. Place sill gasket between the top of wall and top plate. Place the top plate boards with the inside board edge aligned with the interior face of the ICCF wall. Tighten the anchor bolt nuts.

**Builder's Tip:** Decide whether to miter or butt the top plate boards at the corners prior to grouting. That decision will determine how you place the anchor bolts at the corners. If you know the length of the top plate boards that you will be using, you can calculate and mark the placement for the anchor bolts before pouring the grout. This will allow you to place anchor bolts for securing the butt ends of the boards IAW code.

The use of a wood top plate is for placing any wood truss or rafter roof on the top plate and securing the roof to the building top plate with several types of hurricane tie and strap connectors. The wood top plate is, of course, secured to the wall itself with anchor bolts embedded into the concrete filling the ICCF walls. There are many other types and material roofs that can be used with an ICCF wall but only wood truss roofs are discussed here. If you would like to use a different roof, please feel free to call us for guidance.

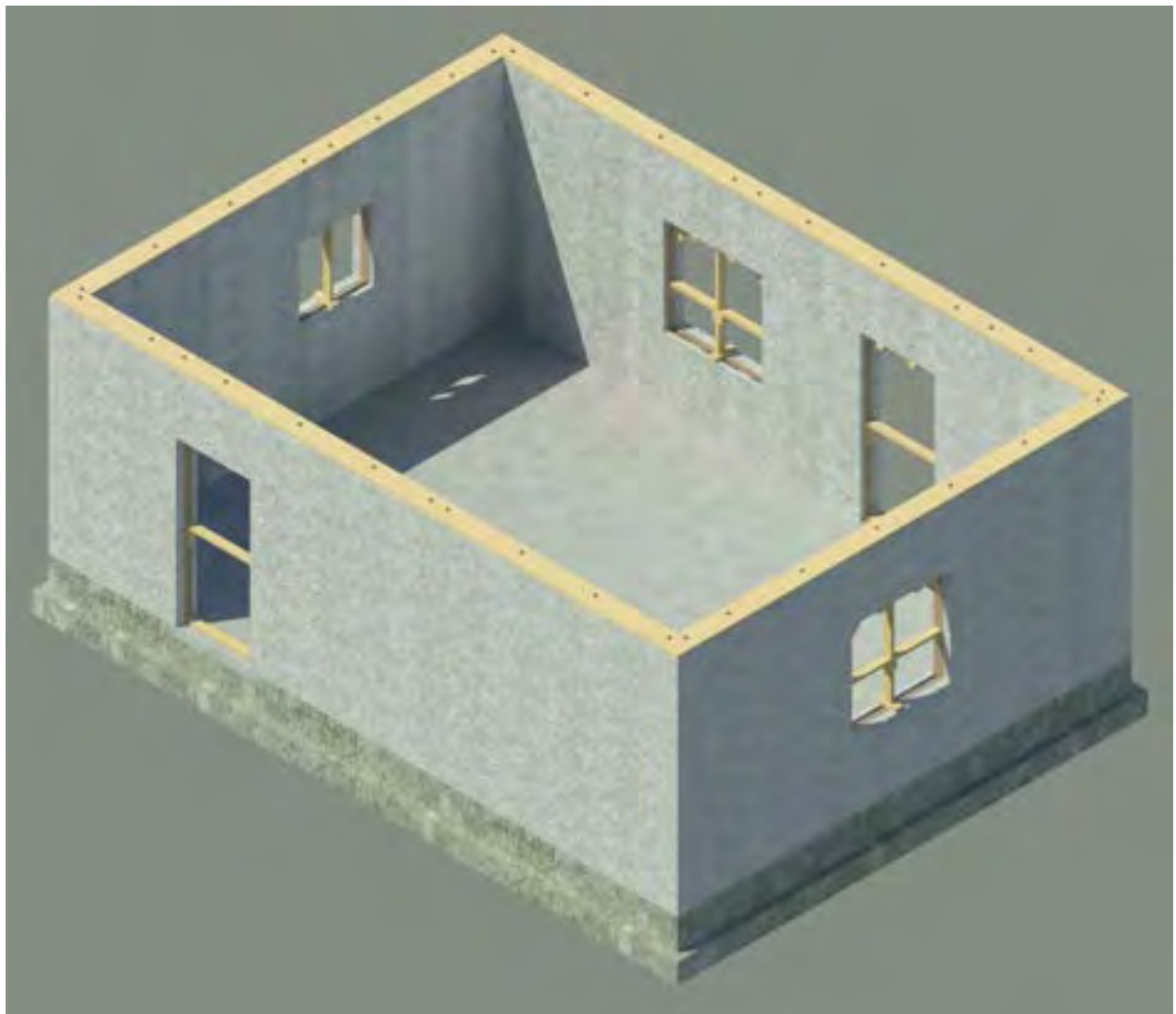

## **WALL CONSTRUCTION**

### **Installing Roof Trusses on Top Plate**

This example is just but one type of roof that can be attached to the top plate. This example is a wood pitched truss roof with gable ends. Many types and different materials and methods of attachment can be used on the top of ICCF walls.

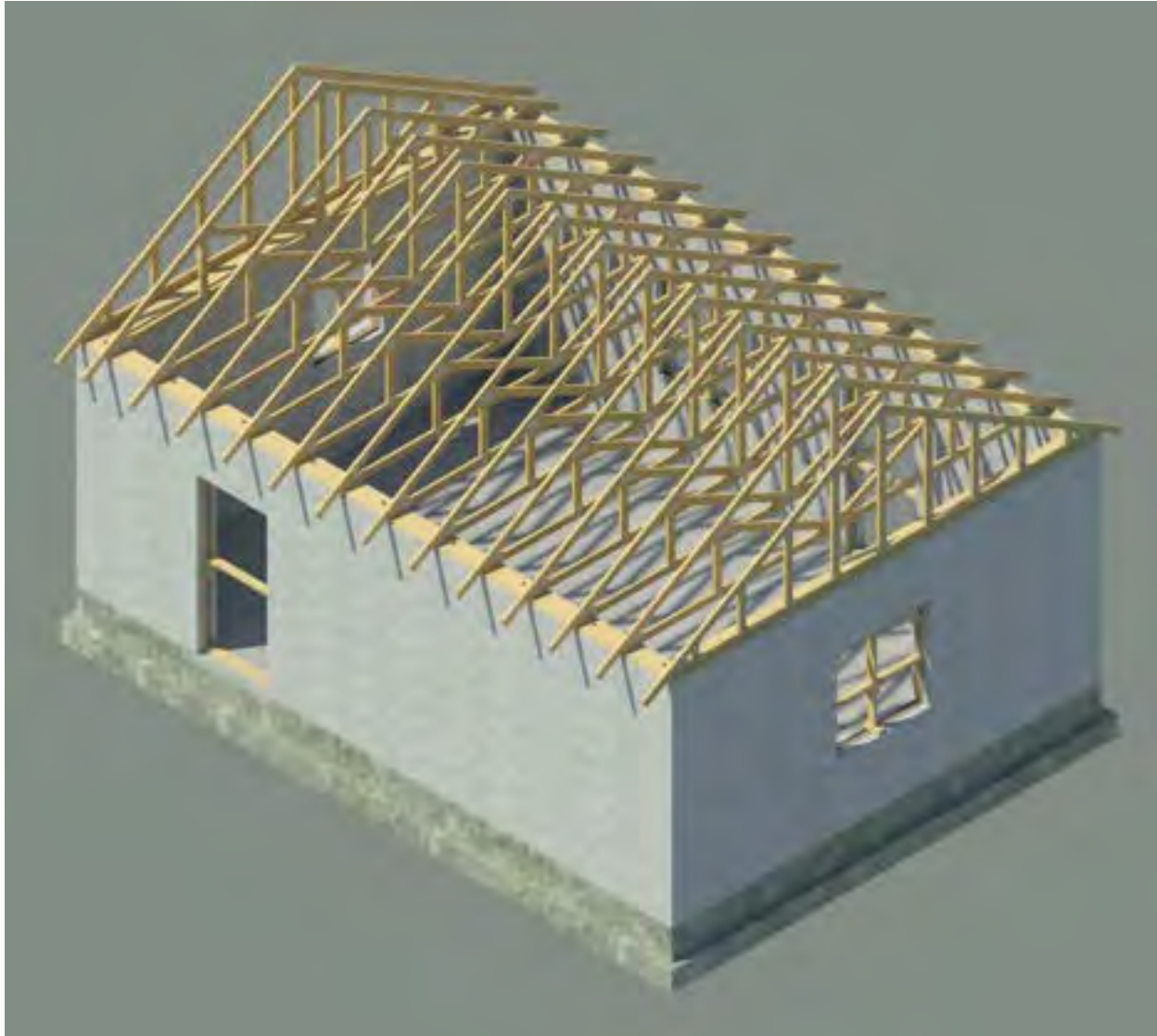

## WALL CONSTRUCTION

### Constructing the First Corner

As described previously, the start of every wall should begin at a corner. The following detail, ICCF 8" BLOCK CORNER CONSTRUCTION (Fig. 7.3) illustrates the placement of the first blocks in a corner (assuming a clockwise build direction). All 90-degree corners can be built this way, stacking identical blocks as you complete each course. An ICCF corner block of the same thickness as the wall block is used to complete the corner.

**Builder's Tip:** Installing the corner blocks on the building corners when four or more courses of ICCF forms have been placed adds tremendous stability to your wall (think of it as a wall brace). But before placing the corner block, confirm proper placement of wall and corner rebar in accordance with your design. Once the corner block is glued and stapled, it will be difficult to determine if a corner bar was omitted (it happens!), so take the opportunity to double check your work.

UPDATED 4/05/19

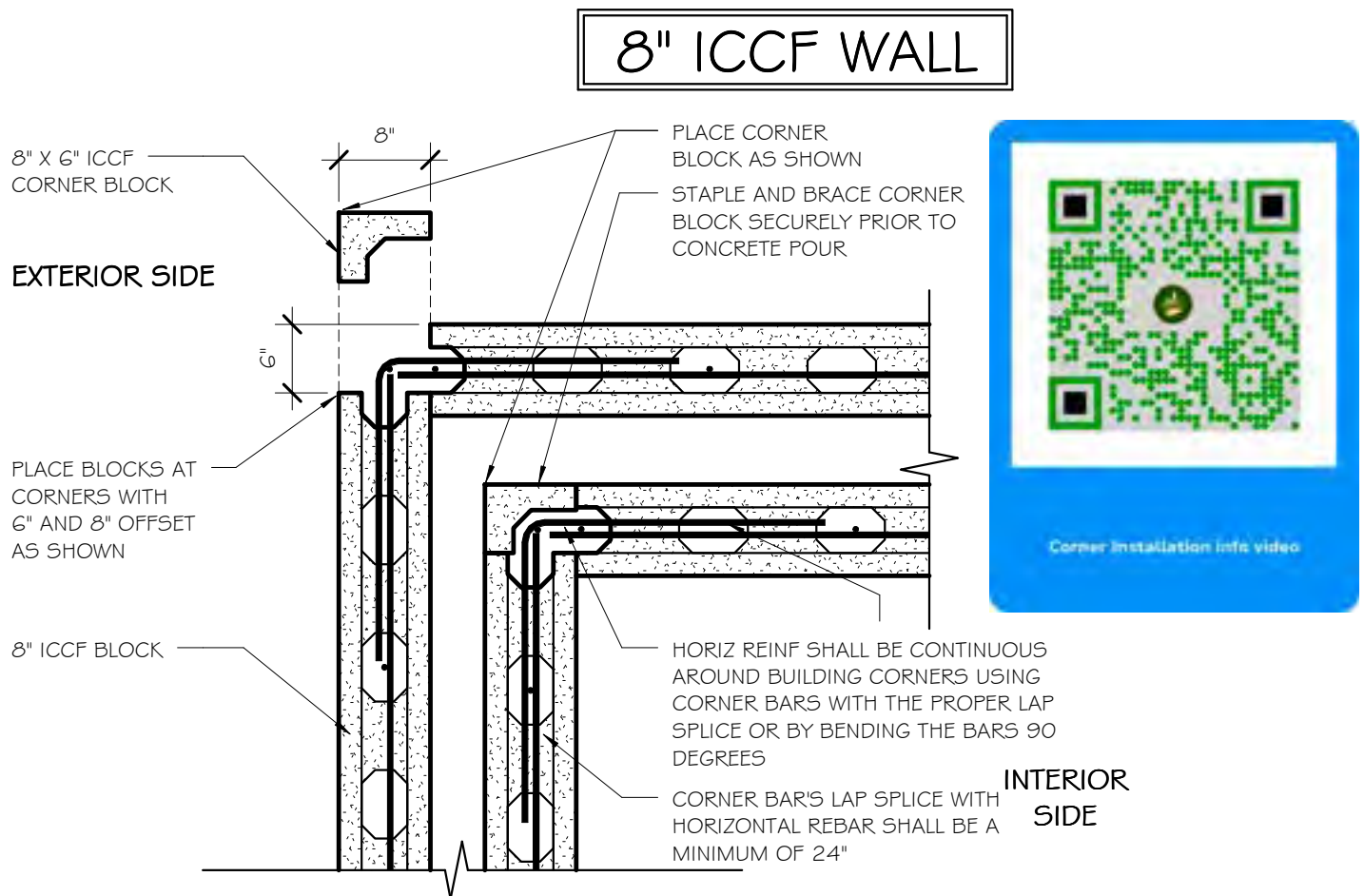

## ICCF 8" WALL CORNER CONSTRUCTION

SCALE: 3/4" = 1'-0"

Figure 7.3

## WALL CONSTRUCTION

### Corner Construction

The image below illustrates a TPB 10" Asymmetric block first course corner construction with the 24" O.C. vertical spacing corner rebar placed.

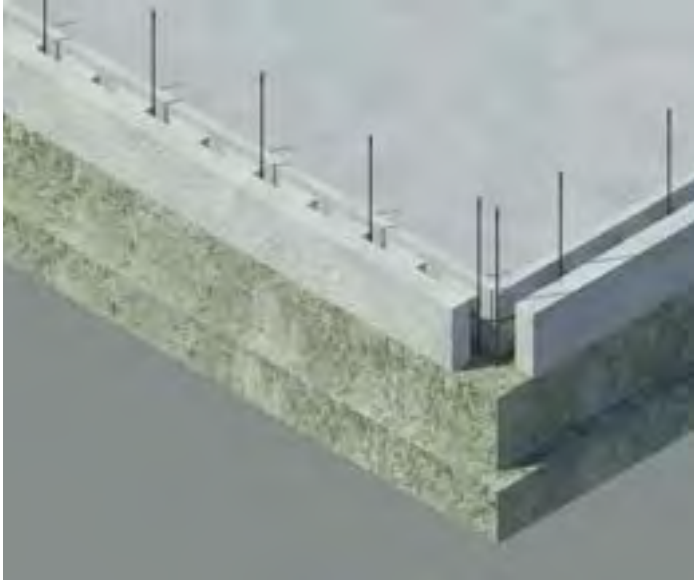

Figure 7.4

The image below is a corner with all cores placed with rebar at 12" O.C.

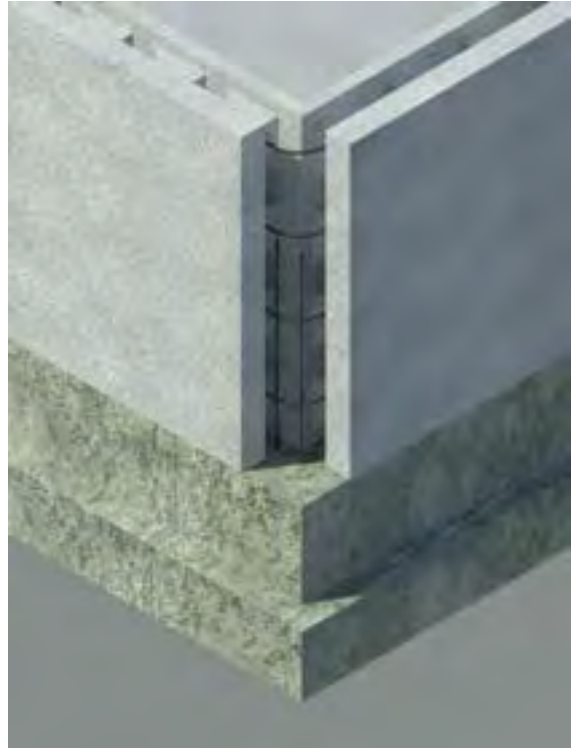

Figure 7.5

The following image does not necessarily represent typical building technique but illustrates corner construction and other building components from an interior view.



Figure 7.6

## WALL CONSTRUCTION

### Corner Staples

Corner staples, along with liberal application of foam adhesive, provide significant mechanical hold to the ICCF corner blocks during grouting the walls with concrete.

Changed  
7/10/21

### Corner Staple Fabrication

To fabricate reusable corner staples, one method is shown below.

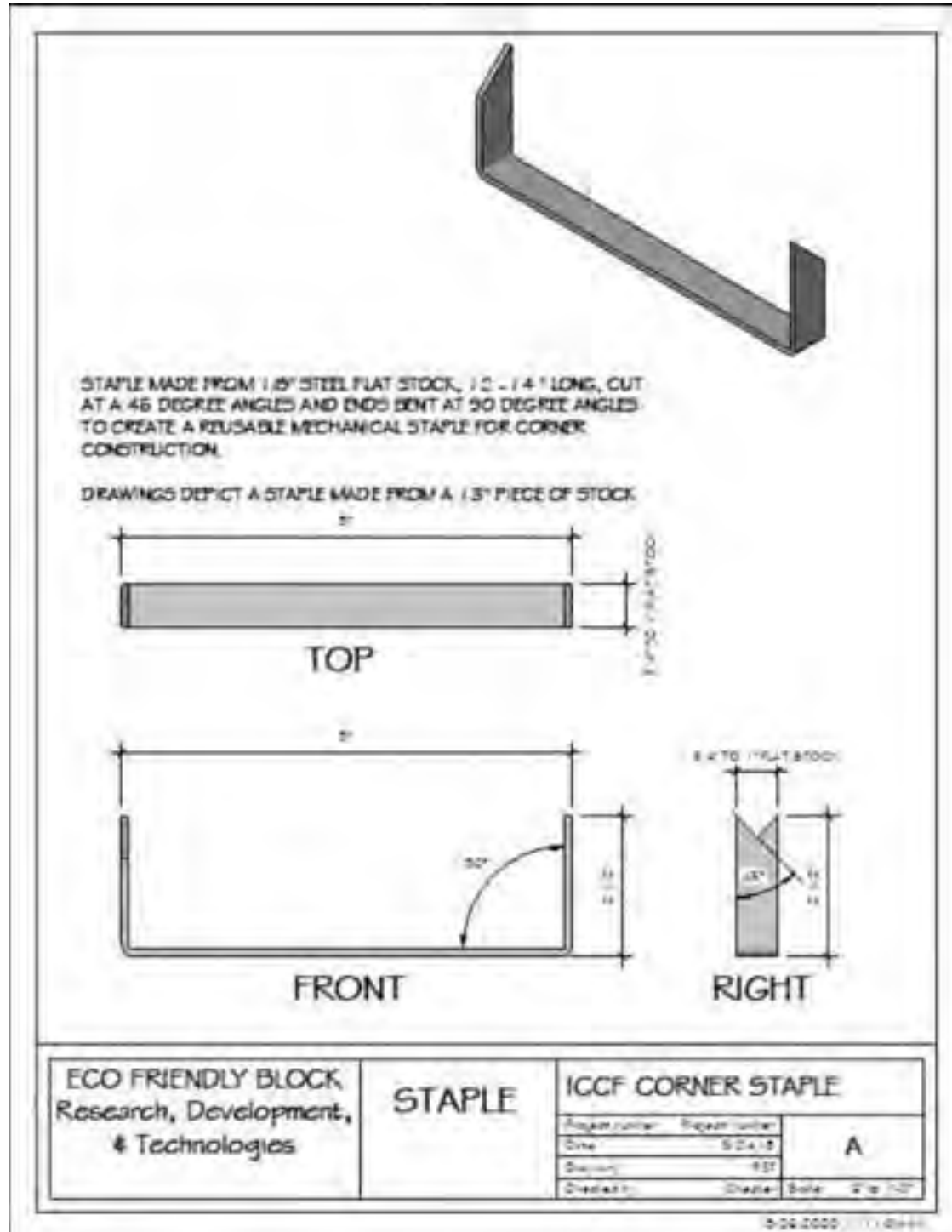

Photo  
Added  
7/10/21



Notice: One staple per course on each side of the corner block.

The wood at the top of the wall is a "buck" to hold back concrete for a beam seat placement for a porch beam during the grout pour.

## WALL CONSTRUCTION

### Jobsite Fabricated Corner Staple

To fabricate corner staples at the jobsite with scrap wood or OSB, one method is shown below.

Added  
7/10/21

(2' x 4' x 1/2\" OSB WITH 4-5, 3\" - 3  
1/2\" NAILS ON EACH END FOR A  
JOBSITE BUILT STAPLE

**OSB WOOD STAPLE**  
SCALE: 3" = 1'-0"

Notice the jobsite fabricated staples on the corner blocks on the second story

ECO FRIENDLY BLOCK Research, Development, & Technologies		<b>OSB Wood Staple</b>												
		<table border="1" style="width: 100%; border-collapse: collapse;"> <tr> <td style="font-size: small;">Project number:</td> <td style="font-size: small;">Project Number:</td> <td rowspan="4" style="text-align: center; vertical-align: middle; font-size: 2em;"><b>B</b></td> </tr> <tr> <td style="font-size: small;">Date:</td> <td style="font-size: small;">2.08.2021</td> </tr> <tr> <td style="font-size: small;">Drawn by:</td> <td style="font-size: small;">Kushan</td> </tr> <tr> <td style="font-size: small;">Created by:</td> <td style="font-size: small;">Chetan</td> </tr> <tr> <td></td> <td style="font-size: small;">Scale:</td> <td style="font-size: small;">3" = 1'-0"</td> </tr> </table>	Project number:	Project Number:	<b>B</b>	Date:	2.08.2021	Drawn by:	Kushan	Created by:	Chetan		Scale:	3" = 1'-0"
Project number:	Project Number:	<b>B</b>												
Date:	2.08.2021													
Drawn by:	Kushan													
Created by:	Chetan													
	Scale:	3" = 1'-0"												
		7/10/2021 11:30:00 PM												

### Jobsite Bracing for Corners

45 degree bracing with 2x lumber and stakes can be substituted or added to other bracing methods to shore up corners before grouting. Additionally, two 2x boards can be attached together to form a vertical "L" to spread the support for the corner blocks over the entire corner vertically and then braced with 45 degree bracing.

**Builder's Tip:** Emphasis placed on sensible and safe grouting technique when pumping concrete will minimize the need for extensive wall and corner bracing. Please review the entire section on Grouting in this manual for needed guidance for grouting wisely. But remember, if you have doubts... just throw up a simple brace.

## WALL CONSTRUCTION

### ICCF "T" Intersection Construction

When building an ICCF wall that intersects within the field of another wall and not creating a corner, that is referred to as a "T" wall or "T" intersection.

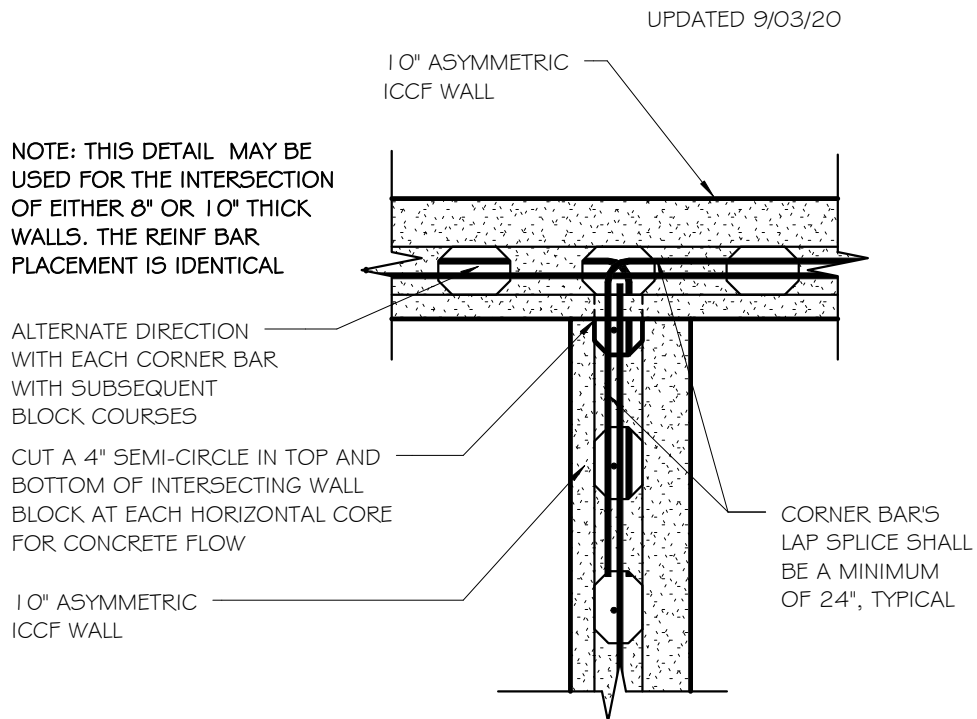

## 10" ASYMMETRIC WALL "T" INTERSECTION

SCALE: 3/4" = 1'-0"

## WALL CONSTRUCTION

### ICCF 45 Degree Corner Wall Construction

When building an ICCF wall for a 45 degree bumpout, a simple 22 1/2 degree cut on each end of two wall blocks will achieve a very strong 45 degree corner.

UPDATED 8/8/23

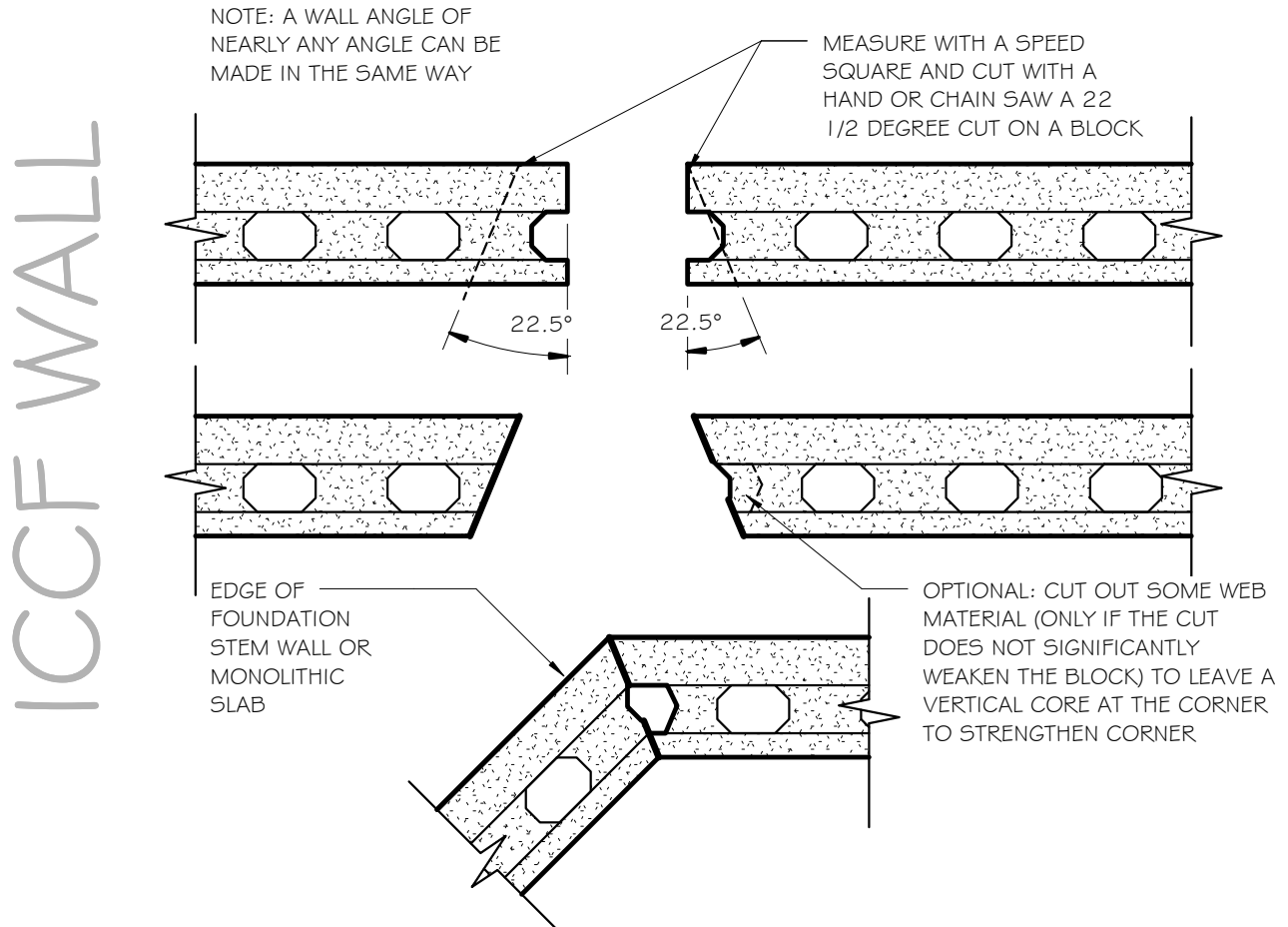

## 45 DEGREE CORNER WALL CONSTRUCTION

SCALE: 3/4" = 1'-0"

## WALL CONSTRUCTION

### Installing ICCF Block Vertically

Typical block construction will likely be laying block horizontally and as earlier suggested, in an identical stack as the previous block course. Because of the symmetrical design of ICCF block, the block may also be installed vertically while maintaining ICCF block's vertical core spacing of 12" on center. Vertical block installation is ideal when building a radius or curved wall.

**Builder's Tip:** Another efficient way to use vertical installation is at door or window openings when the end of the course requires a short block less than 12" long to finish to the opening. A block ripped to that measurement lengthwise and placed vertically could replace several stacked short blocks minimizing several block cuts. These ripped blocks are commonly called "rippers".

### Creating Curved Walls

A testament to the versatility of building with ICCF blocks is how relatively simple it is to construct a curved wall. The most practical method to build a curved wall with ICCF block is to place flange modified blocks vertically on the radius footing or slab. A curved wall begins at the planning stage with your design. Once the design (i.e. radius size, center location, start, and stop) is determined, the footing can be constructed with the proper foundation vertical rebar spacing. Your architect or designer can easily refine the required block modifications for curved walls with any radius dimension. For some general size radius dimensions, a chart is provided for guidance to make the proper sized cuts needed for block modification on the following page.

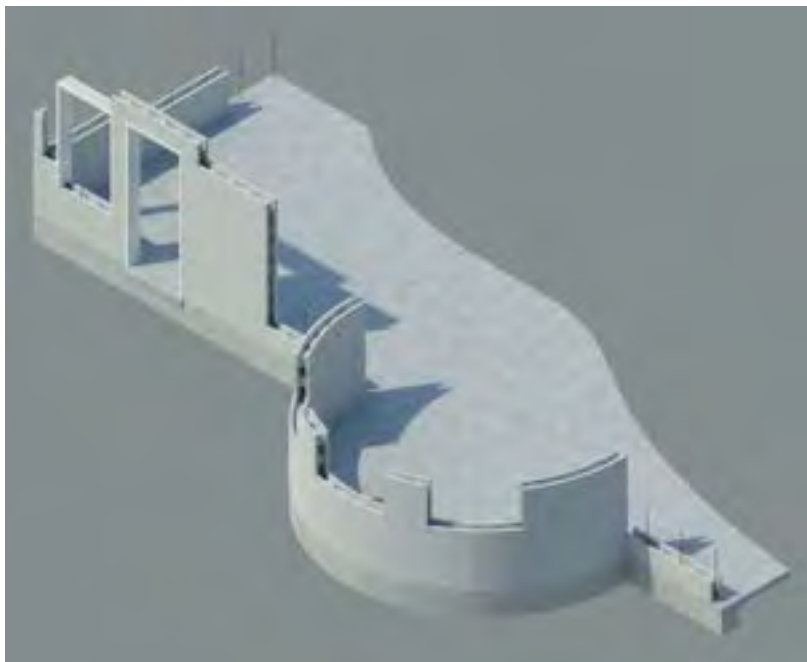
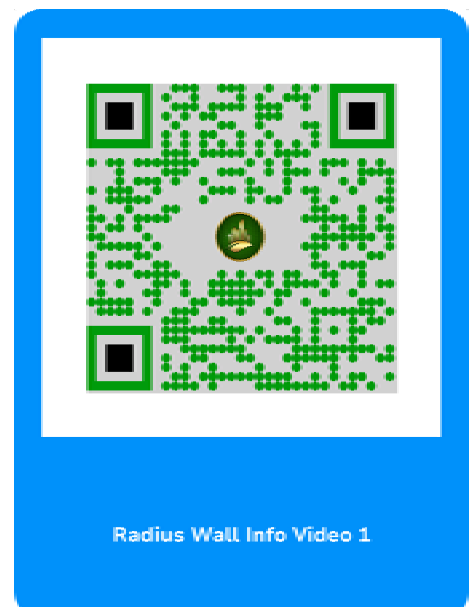
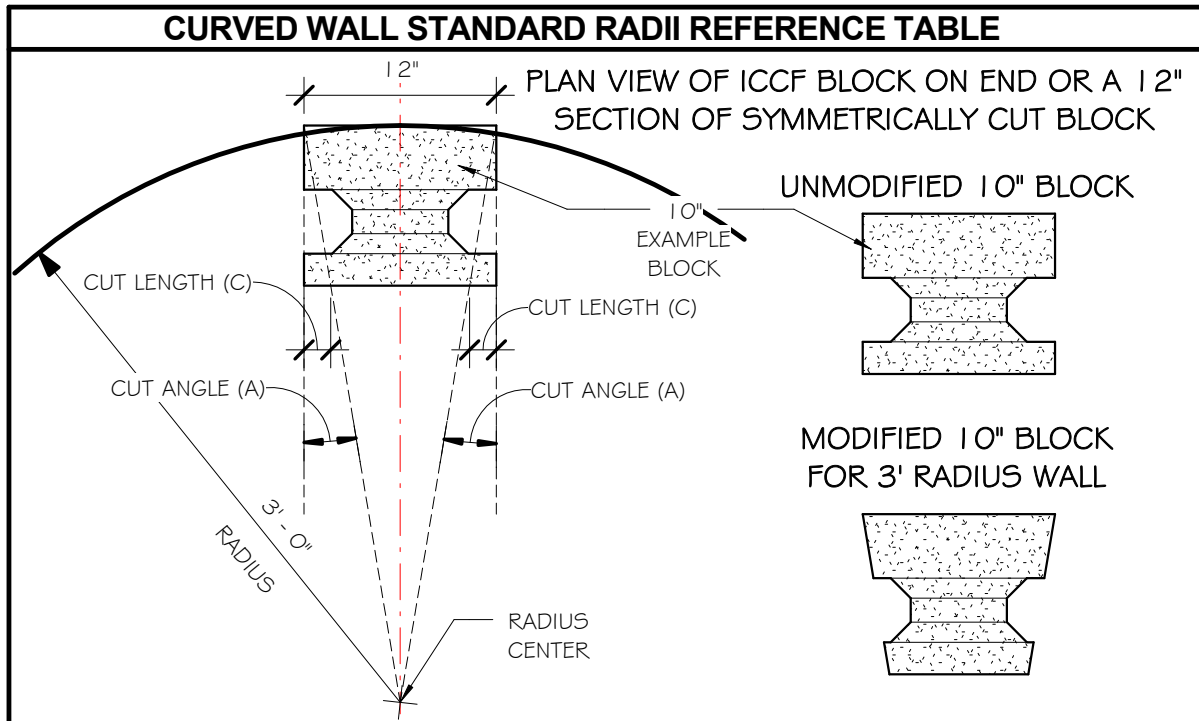

Figure 7.7



## WALL CONSTRUCTION Creating Curved Walls (Cont.)



**BLOCK CUTS FOR STANDARD RADII**

Radius	6" Block		8" Block		10" Block	
	Cut Angle (A)	Cut Length (C)	Cut Angle (A)	Cut Length (C)	Cut Angle (A)	Cut Length (C)
1'	26.6°	3"	26.6°	4"	26.6°	5"
2'	14.0°	1 1/2"	14.0°	2"	14.0°	2 1/2"
3'	9.5°	1"	9.5°	1 5/16"	9.5°	1 11/16"
4'	7.1°	3/4"	7.1°	1"	7.1°	1 1/4"
5'	5.7°	5/8"	5.7°	13/16"	5.7°	1"
6'	4.8°	1/2"	4.8°	11/16"	4.8°	13/16"
7'	4.1°	7/16"	4.1°	9/16"	4.1°	11/16"
8'	3.6°	3/8"	3.6°	1/2"	3.6°	5/8"
9'	3.2°	5/16"	3.2°	7/16"	3.2°	9/16"
10'	2.9°	5/16"	2.9°	3/8"	2.9°	1/2"
11'	2.6°	1/4"	2.6°	3/8"	2.6°	7/16"
12'	2.4°	1/4"	2.4°	5/16"	2.4°	7/16"
15'	1.9°	3/16"	1.9°	1/4"	1.9°	5/16"
20'	1.4°	1/8"	1.4°	3/16"	1.4°	1/4"
25'	1.1°	1/8"	1.1°	3/16"	1.1°	3/16"
30'	1.0°	1/16"	1.0°	1/8"	1.0°	1/8"

- Angle measurements to nearest .1 of a degree
- Cut length measurements to the nearest 1/16"
- For fractional radii, use interpolation

Figure 7.8

## WALL CONSTRUCTION

### Creating a Curved Wall (Cont.)

The following detail illustrates the modifications needed to blocks that will be placed vertically on a curved wall with a 3' radius.

### EXAMPLE 3' RADIUS WALL USING 8" ICCF WALL BLOCK

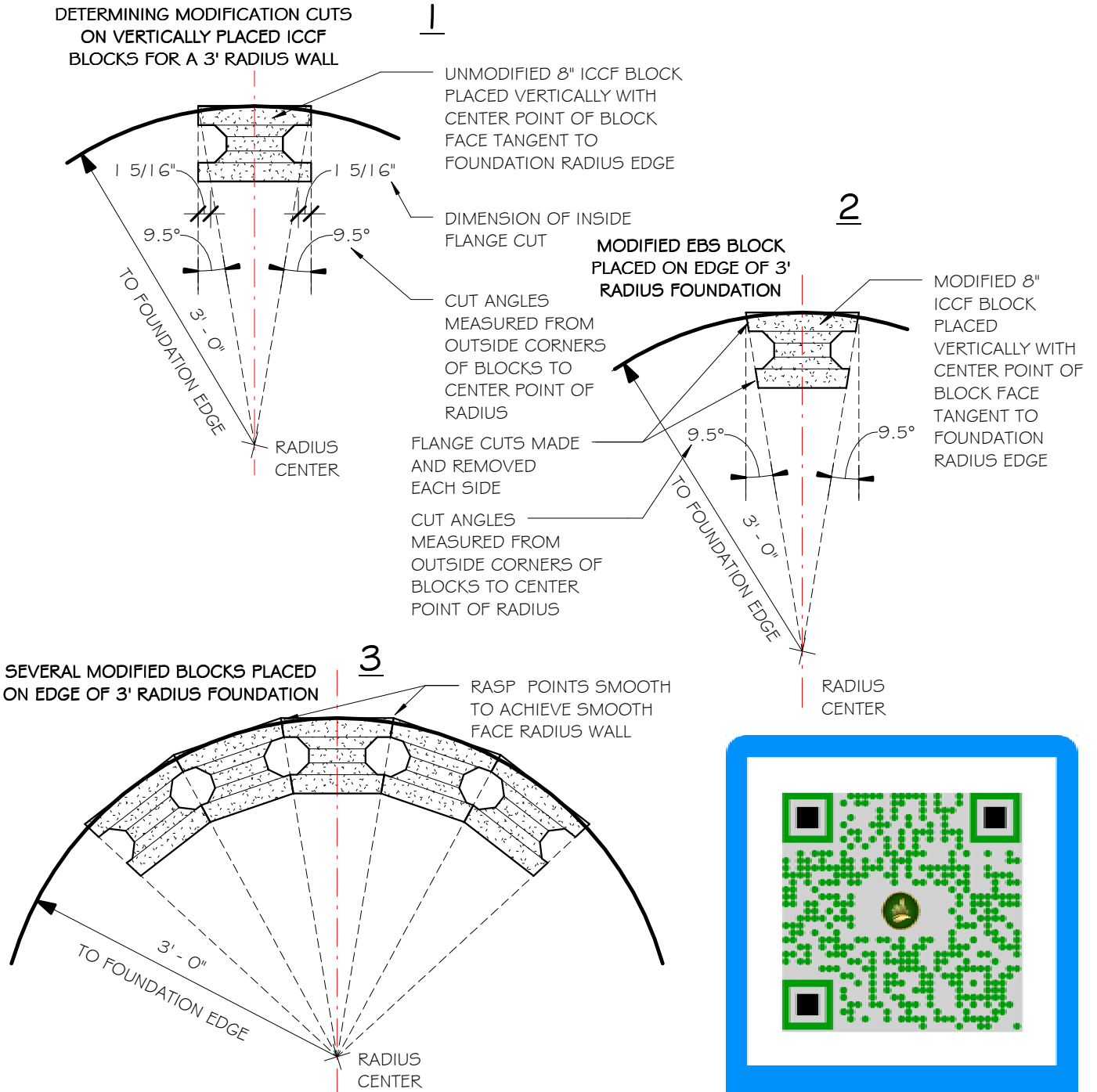
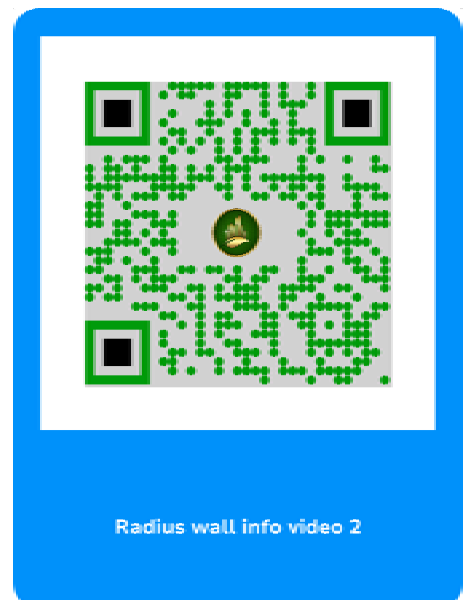

Figure 7.9



## WALL CONSTRUCTION

### Creating a Curved Wall (Cont.)

A comparison of the following detail of a 10' radius curved wall with the 3' radius wall detail on the previous page illustrates that as the radius of the curved wall increases the flange cuts and cut angles required to modify the curved wall blocks become smaller. Also, the block points on the outside of the wall require less rasping to smooth the radius wall.

### EXAMPLE 10' RADIUS WALL USING 8" ICCF WALL BLOCK

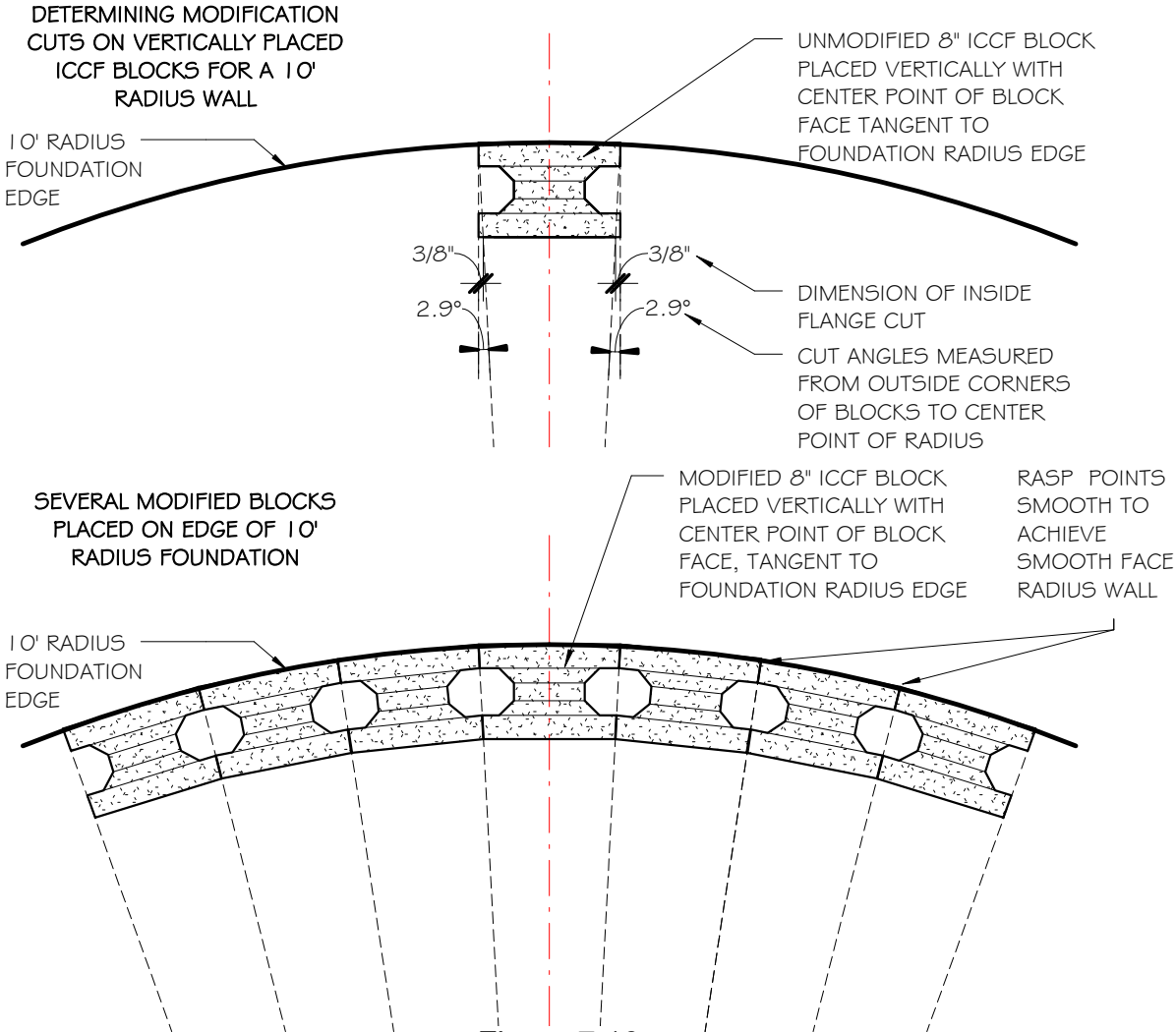

Figure 7.10

**Builder's Tip:** When radii are larger, i.e 20', 25', 30' and so on, it may not be feasible to use a circular saw with the blade angled to make the angle cuts because the angles required are so small. Careful rasping of the block flange edges to achieve a softened edge that is equivalent to the cut angle and cut length on each block flange will provide the best results for larger radii block placement.

## WALL CONSTRUCTION

### Creating a Curved Wall (Cont.)

These two images represent a 8' radius curved wall with three window openings under construction. These images do not necessarily represent typical building technique but illustrate curved wall construction and other building components including vinyl bucks for the nearby window and door.

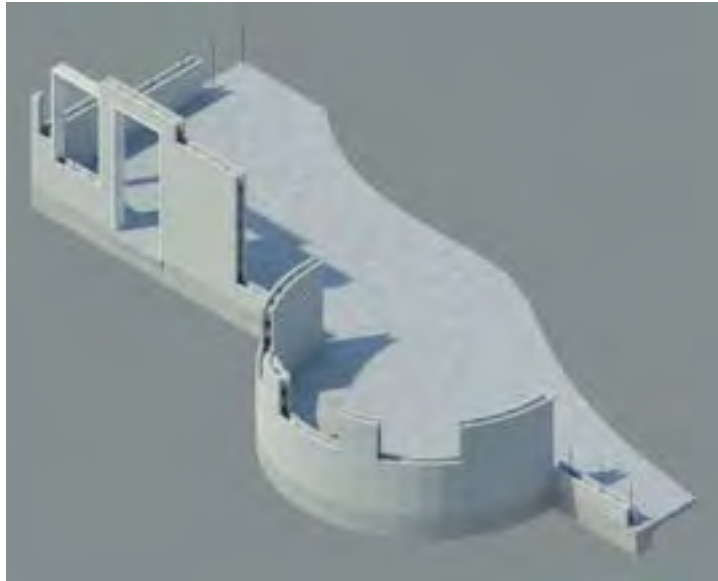

Figure 7.11

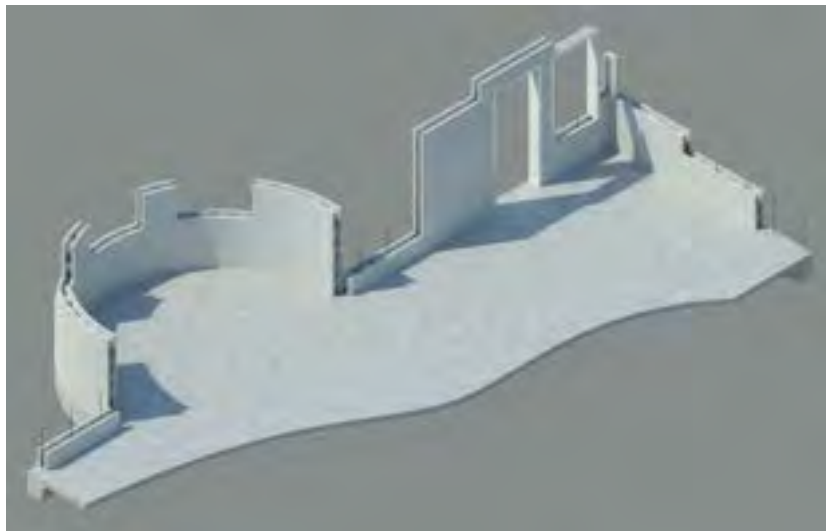
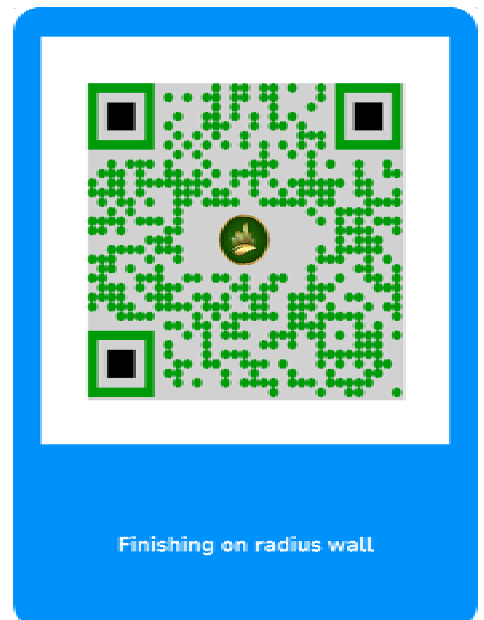

Figure 7.12



### Placing Rebar in a Curved Wall

Placing rebar in a curved wall that is built with blocks on the vertical obviously cannot be placed in each course as with a straight wall with blocks placed horizontally. The rebar be must be bent to the same curvature as the curved wall. The curved rebar can be "fished" in the horizontal core from the sides at the spacing required by design or place the required curved rebar for the height of the wall at the wall edge and slide a block into place with the required rebar spacing on the wall one at a time.

## WALL CONSTRUCTION

### Curved Wall Photo Gallery



## WALL CONSTRUCTION

### Rebar Placement Around Openings

Place a vertical rebar in each vertical core adjacent to each side of each opening. Your design vertical rebar spacing may leave a vertical core adjacent to the edge of an opening empty but residential and commercial code requires that a minimum of one vertical rebar be placed within 12" of each edge of an opening.

### Supporting Openings

Creating door and window openings in an ICCF wall will require "bucks" to finish the opening to block the flow of concrete into the opening during grouting. ("Bucks" are the framing within an opening that support the lintel and holds back fluid concrete during grouting.) There are many methods to "buck" an opening, 2X4, 2X6, 2X8, 2X10 dimensional lumber, engineered wood, LVL, or OSB (double layer of 1/2" OSB can be substituted for dimensional lumber) cut to block width, extruded vinyl bucks, and even using ICCF end elements to frame an opening.

The bucking method shown below in the photos is using pressure treated (PT) 2X dimensional lumber. This home was built with 10" ICCF block with a 4" core thickness, so PT 2X4 bucking was used.

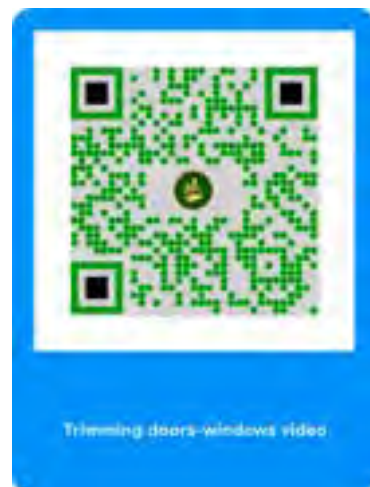
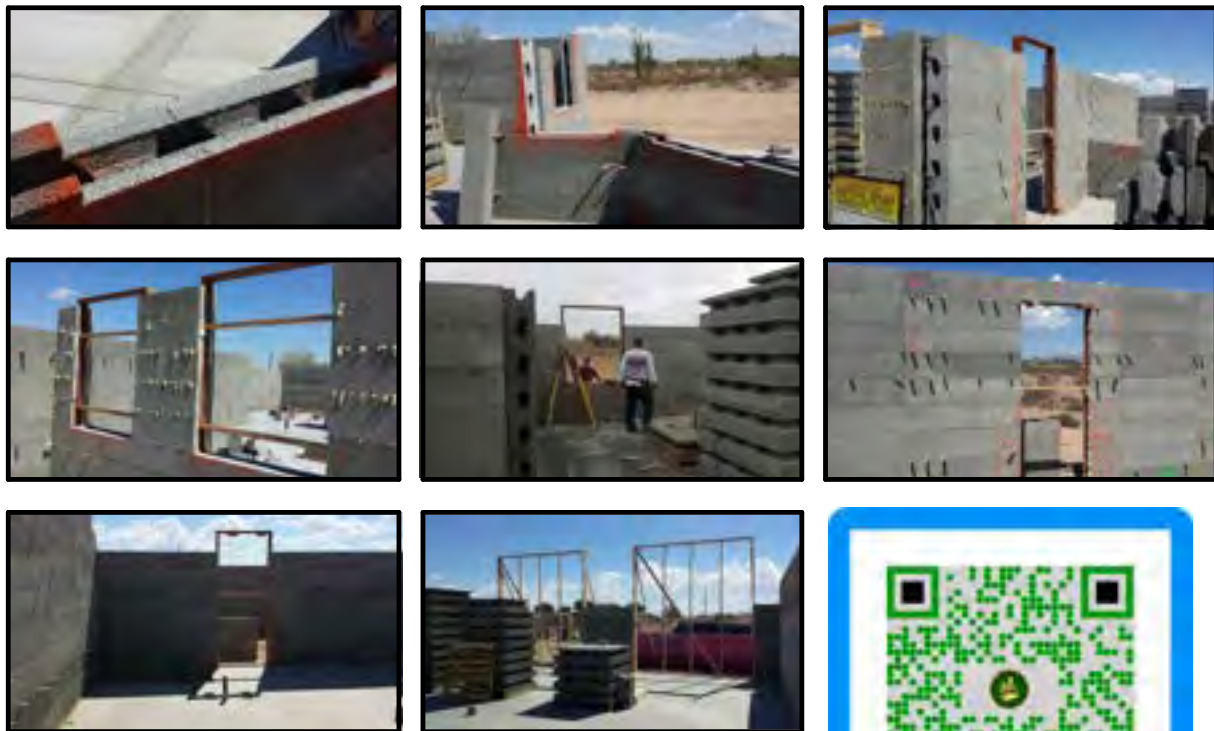

## WALL CONSTRUCTION

### Supporting Openings (Cont.)

ICCF wall installers must give special consideration to the construction and installation of wood door and window bucks.

### **Methods of Wood Buck Construction**

There are many ways constructing wood door and window bucks. The list below describes a few of the methods that can be used:

1. External stay-in-place buck or fin nailer insert - Typically, PT lumber, flush with the interior face of ICCF wall, wide enough to cover the internal ICCF cores and the interior dimensions are the rough opening dimensions for the window - to create a fin nailer for windows with fins for attachment. (See page 7.13a.1)
2. Internal- Inset or recess the PT lumber buck into the cavity of the form that stays-in-place and becomes a nailer for a window without fins or nailer for a fin nailer insert. Commonly called a "flush buck". (See rendering below and page 7.13a.2)
3. Combination with both 1 and 2. (See page 7.13a.3)
4. External removable buck - same as #1 but the buck is temporary lumber scrap and removed after grouting. (See page 7.13a.4)

Pre-building the bucks to the rough opening dimensions on or off-site will increase on-site productivity. If the wood buck method you use will be a stay-in-place buck, the buck must be anchored to the concrete grout during the wall grout pour using lag or anchor bolts, only on the two vertical stiles at 24" on center aligned with the horizontal cores.

Changed  
8/09/24

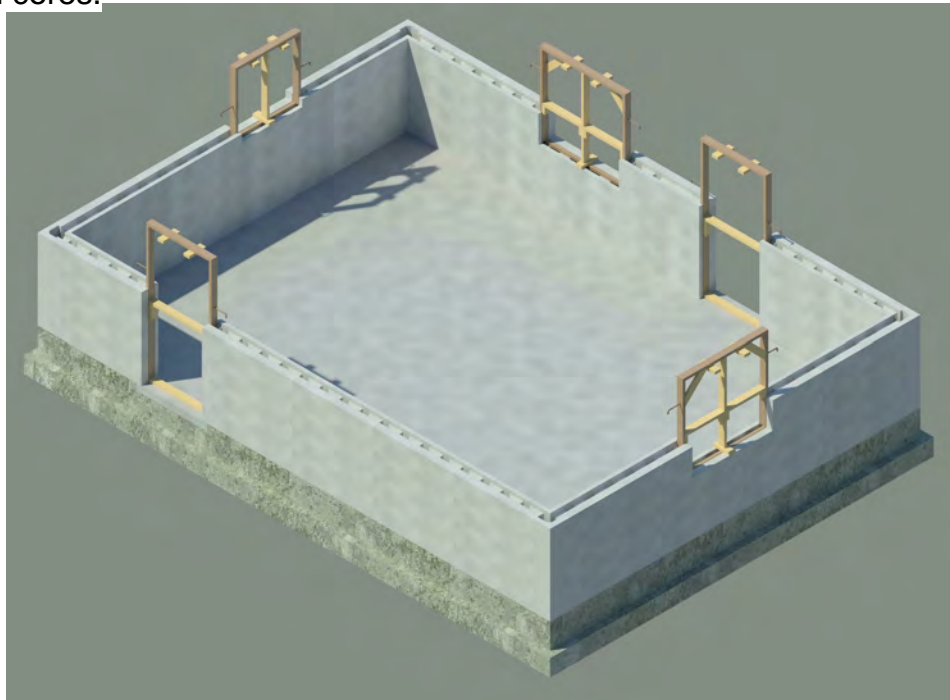

7.13a

## WALL CONSTRUCTION

### Supporting Openings (Cont.)

#### Method One

##### The Stay-In-Place Fin Nailer Buck

The external stay-in-place buck method: The PT 2x buck is built to the rough opening dimensions of the window or door and is placed so that the interior edges are flush with the interior face of the ICCF wall. Depending upon the form core width, the 2x will need to cover the form core width. Bucks are glued in place with foam adhesive to the ICCF wall. Scrap lumber or OSB on the corners is used to square and add extra support to the buck. Driving 3-inch drywall screws through the ICCF block and into the wood bucks from the interior side, will add additional strength to keeping the buck square and in place. This method provides a fin/flange nailer for "finned" windows.

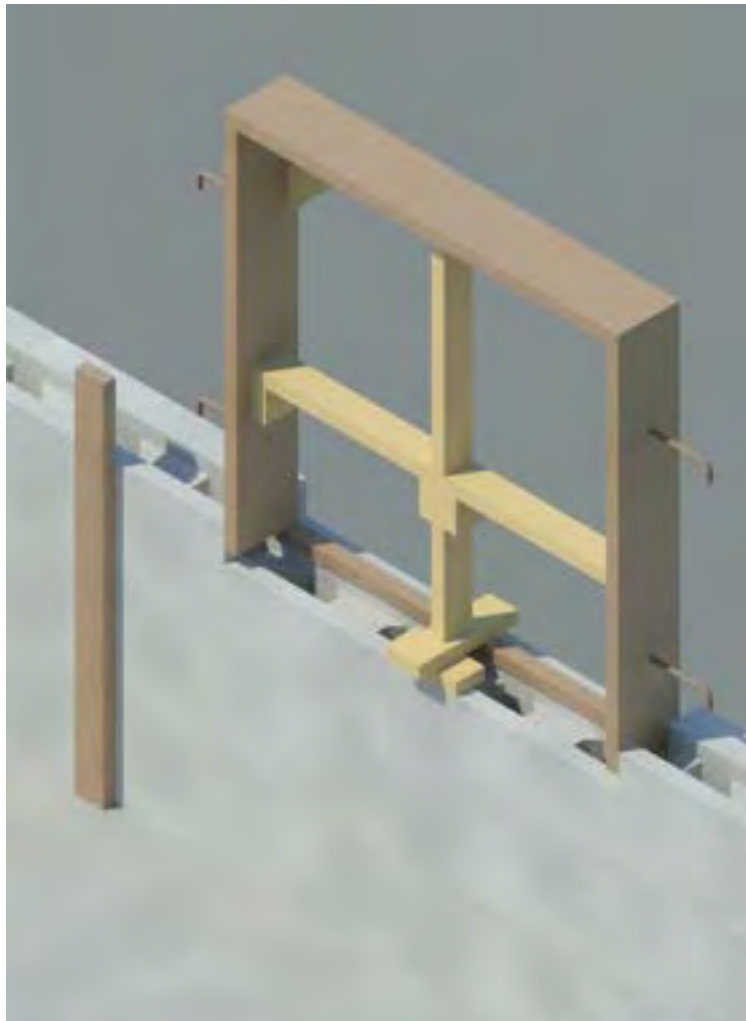

The PT board standing to the left of the window is to be placed and secured to the buck at the bottom of the buck after the grout pour. The narrow board at the bottom of the buck is to provide viewing the concrete grout as it is pumped in from side holes while keeping the buck square.

## WALL CONSTRUCTION

### Supporting Openings (Cont.)

#### Method Two

##### The Stay-In-Place Flush Nailer Buck

The second method is often used for projects that will have a stucco exterior finish or when thermal bridging is a concern. It also uses less materials than the first method, and is useful when the total wall thickness exceeds 10 inches. The “internal buck” uses 2x material cut to the width of the concrete cavity, and is placed flush into the cavity of the cut form. The buck is well glued in the cores and long drywall screws can be driven through the interior face of the ICCF into the wood to aid in securing the buck. This method works well for bucking doors too. The 2X cross supports on the underside of the top cross piece are needed to support the block placed over the opening.

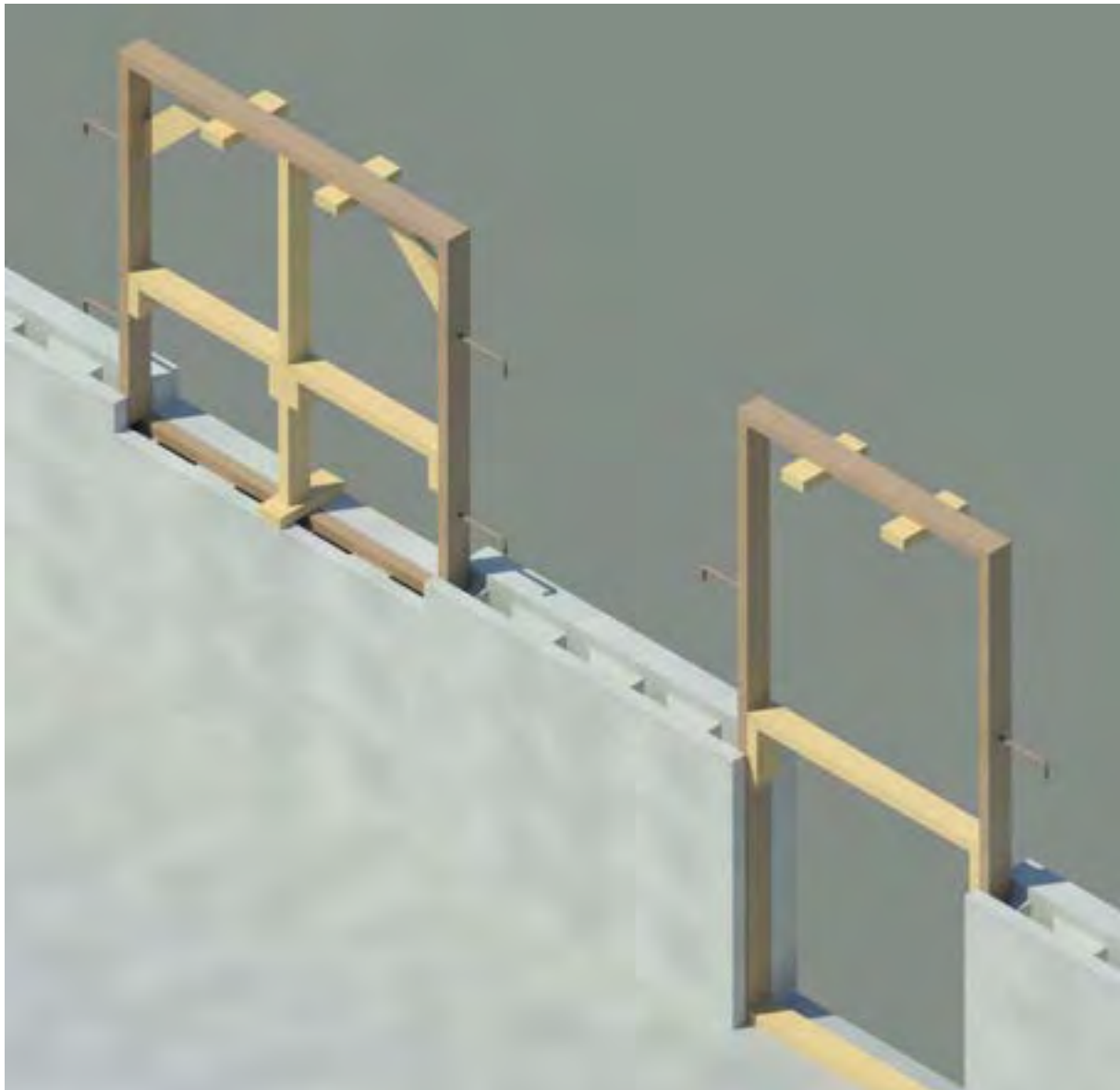

## WALL CONSTRUCTION

### Supporting Openings (Cont.)

#### Method Three

Method Three is a combination of both Method 1 and Method 2. A stay-in-place flush nailer is placed in an opening cut 3" over the rough opening measurement. And after grouting, a stay-in-place fin nailer is installed and secured to the flush nailer to attach and caulk a finned window.

Changed  
8/09/24

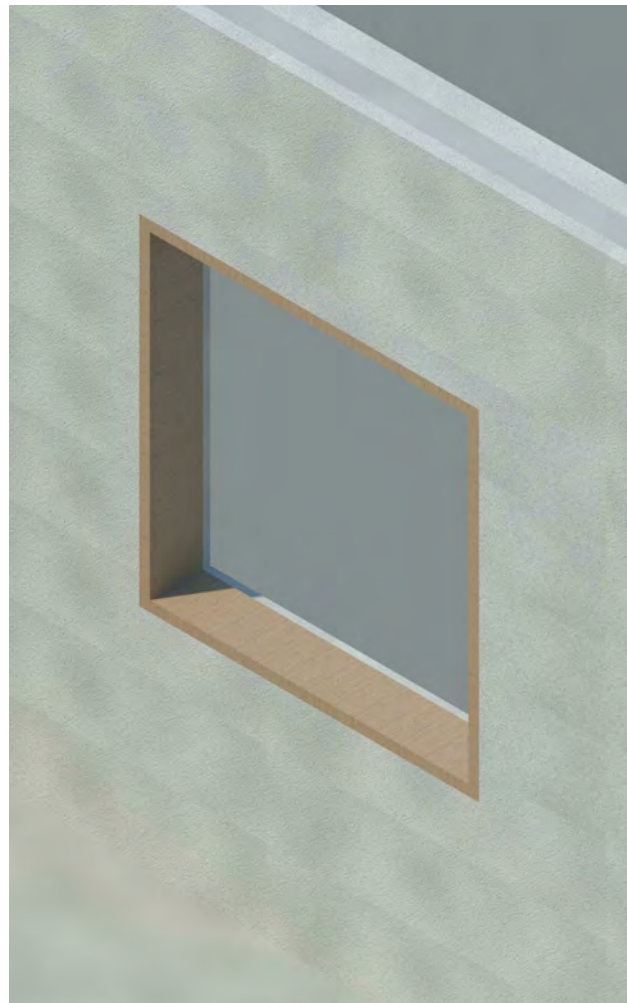
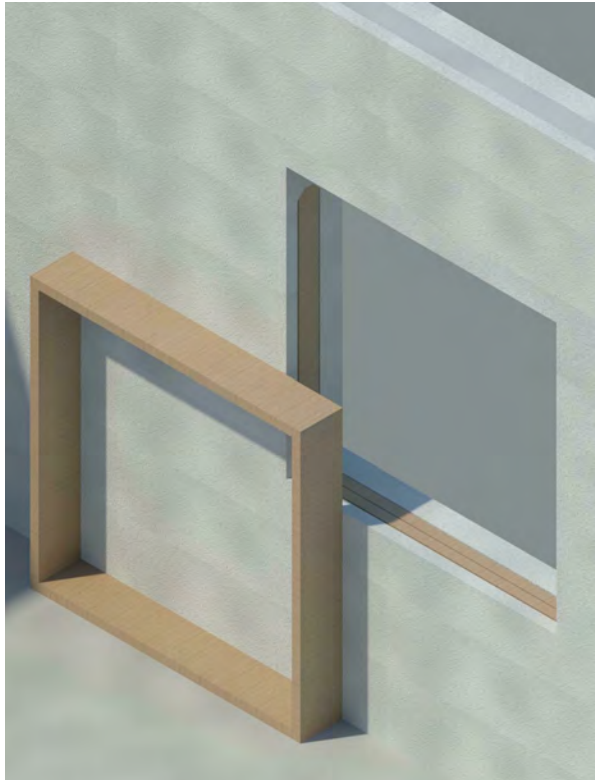

## WALL CONSTRUCTION

### Supporting Openings (Cont.)

#### **Method Four**

##### Temporary buck

This method uses scrap or reusable lumber to "buck" the opening and then is removed after grouting. The opening is bucked as in Method One (without anchors) but since the buck will be removed, PT wood is not required. This method will not accommodate a "finned" window unless the opening measurement was made to be able to add a fin/flange nailer after grouting. This method works well for bucking doors too. The 2X cross supports on the underside of the top cross piece are not needed to support the block placed over the opening because the width of the bucks must be wide enough to block the internal cores and support the forms over the opening. The plywood scabs aid in squaring the buck and keeping it flush with the interior face of the ICCF wall.

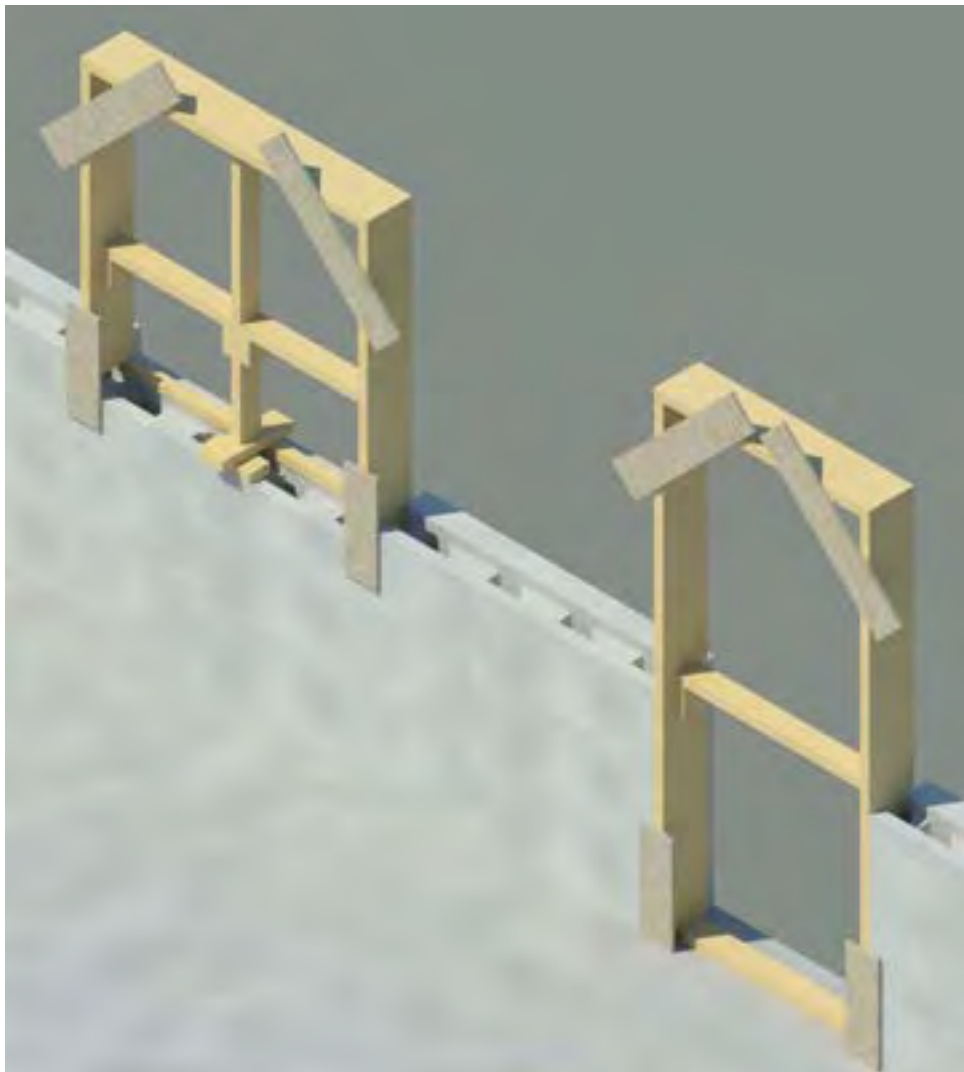

## WALL CONSTRUCTION

### Supporting Openings (Cont.)

FOR BEST RESISTANCE TO MOISTURE MIGRATION, THE ROUGH OPENING SHOULD BE PAINTED, ROLLED, OR TROWELLED WITH A RUBBERIZED OR ASPHALT WATERPROOFING BEFORE WINDOW INSTALLATION.

IF PEEL-N-STICK FLASHING IS TO BE USED TO FLASH THE WINDOWS, CARRY THE WATERPROOF COATING AN ADDITIONAL 6" OR MORE AROUND THE EXTERIOR OF WHERE THE WINDOW IS TO BE PLACED TO PROVIDE A STICKING SURFACE FOR THE PEEL-N-STICK.

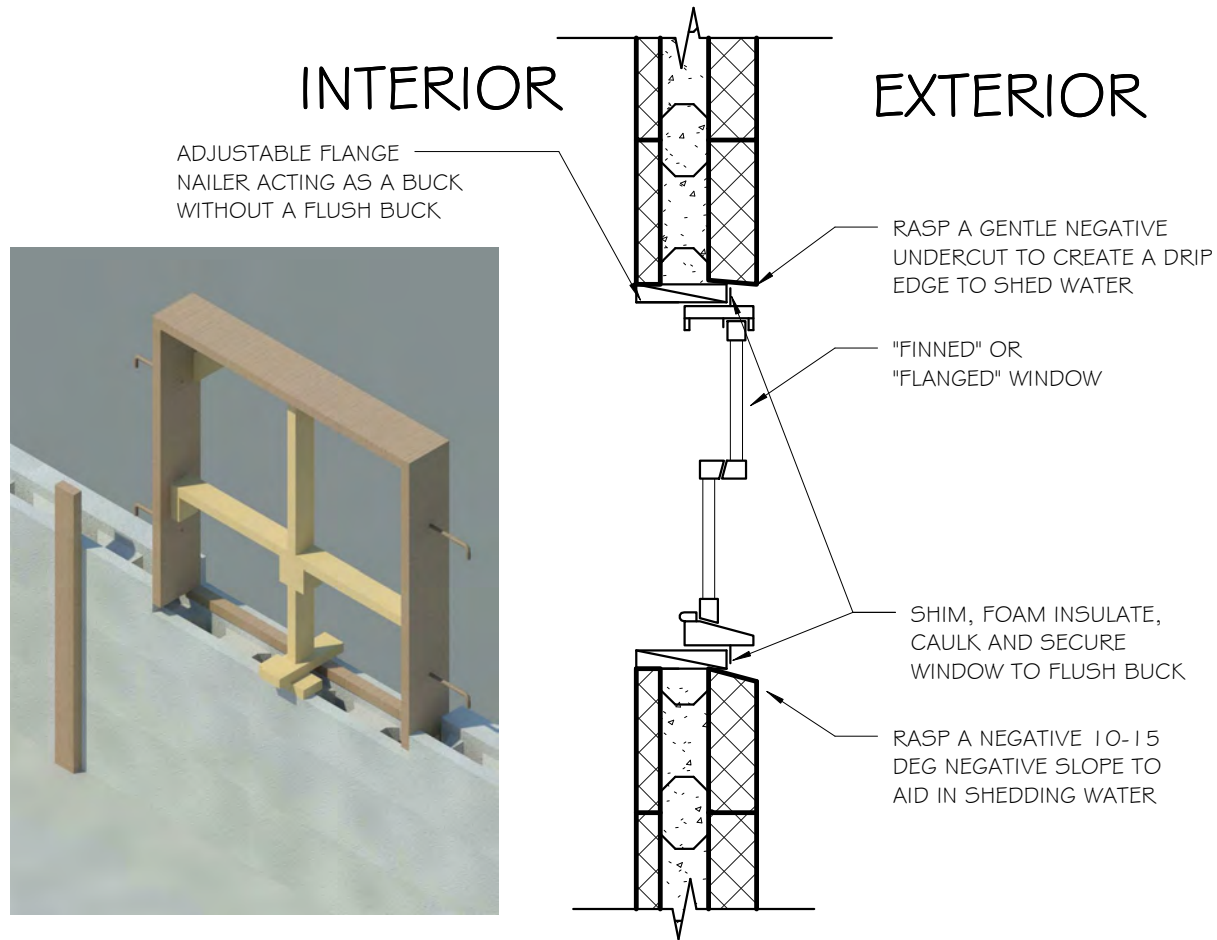

THIS DETAIL REPRESENTS A SECTION VIEW OF THE METHOD 1 BUCK INSTALLATION. THIS METHOD UTILIZES A PT 2X THAT IS ADJUSTABLE WITHIN THE THICKNESS OF THE WALL. IF NO FLUSH BUCK IS USED, THEN THE 2X NAILER MUST BE WIDE ENOUGH TO COVER THE BLOCK CORES.

THE ROUGH OPENING WOULD BE LARGE ENOUGH TO FIT A BLOCK FRAME (NO FIN) WINDOW OR A FINNED WINDOW (AS SHOWN) PLUS A 1/4" FOR SHIMMING.

## BUCK METHOD 1 SECTION VIEW DETAIL

SCALE: 3/4" = 1'-0"

## WALL CONSTRUCTION

### Supporting Openings (Cont.)

#### METHOD TWO BUCKING AND BLOCK FRAME WINDOW INSTALLATION

FOR BEST RESISTANCE TO MOISTURE MIGRATION, THE ROUGH OPENING SHOULD BE PAINTED, ROLLED, OR TROWELLED WITH A RUBBERIZED OR ASPHALT WATERPROOFING BEFORE WINDOW INSTALLATION.

IF PEEL-N-STICK FLASHING IS TO BE USED TO FLASH THE WINDOWS, CARRY THE WATERPROOF COATING AN ADDITIONAL 6" OR MORE AROUND THE EXTERIOR OF WHERE THE WINDOW IS TO BE PLACED TO PROVIDE A STICKING SURFACE FOR THE PEEL-N-STICK.

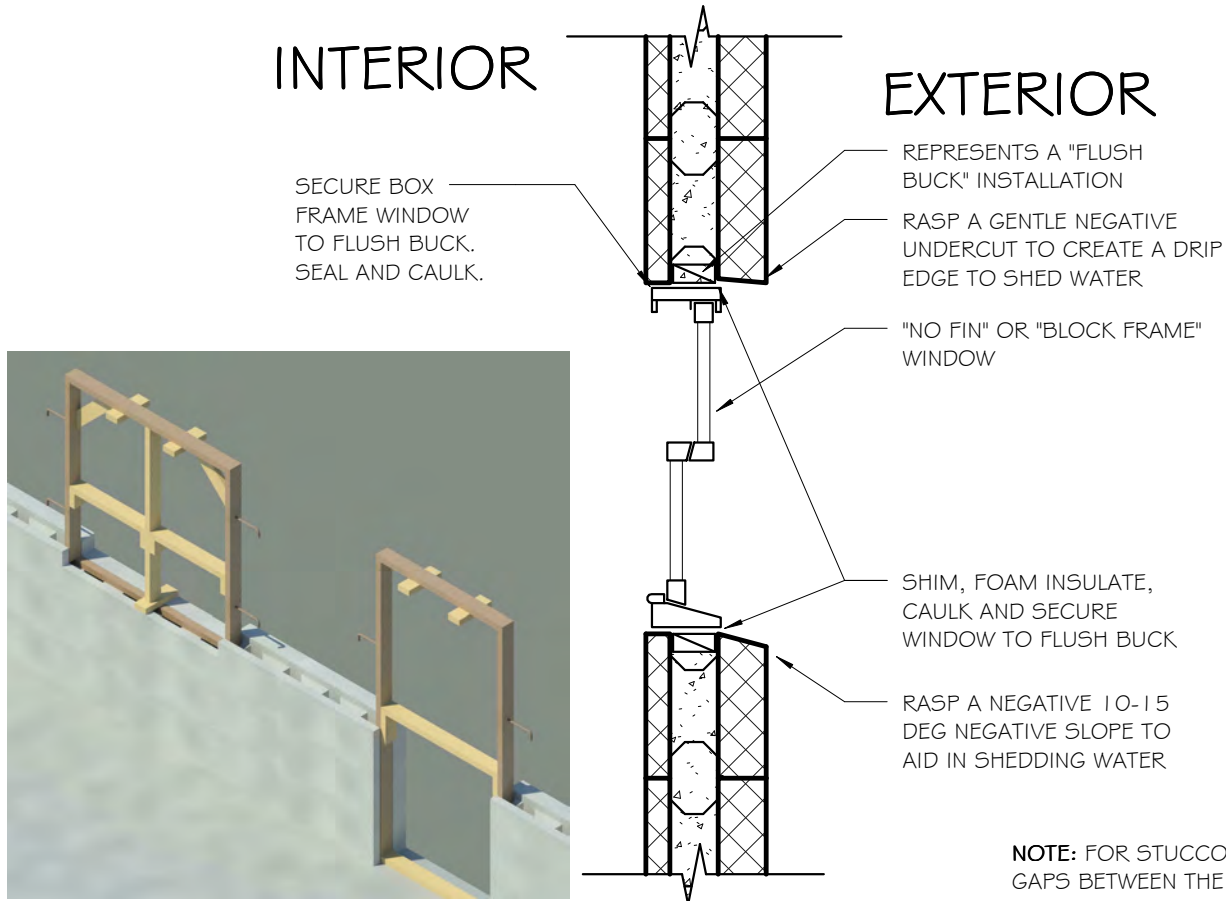

THIS DETAIL REPRESENTS A SECTION VIEW OF THE METHOD 2 BUCK INSTALLATION. THIS METHOD UTILIZES A PT 2X4 THAT FITS FLUSH IN THE 4"X6" CORE OF A 10" ASYMMETRIC BLOCK OR AN 8" BLOCK WALL.

THE ROUGH OPENING WOULD BE LARGE ENOUGH TO FIT A BLOCK FRAME (NO FIN) WINDOW PLUS A 1/4" FOR SHIMMING.

**NOTE:** FOR STUCCO CLADDING: GAPS BETWEEN THE WINDOW AND ROUGH OPENING CAN BE FILLED WITH SHAPED ICCF PIECES GLUED IN THE VOIDS.

WHEN COATED WITH WATERPROOFING AND FLASHED, THE STUCCO CONTRACTOR WILL COVER FLASHING WITH CHICKEN WIRE AND STUCCO AROUND THE WINDOW.

## BUCK METHOD 2 SECTION VIEW DETAIL

SCALE: 3/4" = 1'-0"

## WALL CONSTRUCTION

### Supporting Openings (Cont.)

#### COMBO METHOD ONE & TWO BUCKING AND FLANGE WINDOW INSTALLATION

FOR BEST RESISTANCE TO MOISTURE MIGRATION, THE ROUGH OPENING SHOULD BE PAINTED, ROLLED, OR TROWELLED WITH A RUBBERIZED OR ASPHALT WATERPROOFING BEFORE WINDOW INSTALLATION.

IF PEEL-N-STICK FLASHING IS TO BE USED TO FLASH THE WINDOWS, CARRY THE WATERPROOF COATING AN ADDITIONAL 6" OR MORE AROUND THE EXTERIOR OF WHERE THE WINDOW IS TO BE PLACED TO PROVIDE A STICKING SURFACE FOR THE PEEL-N-STICK.

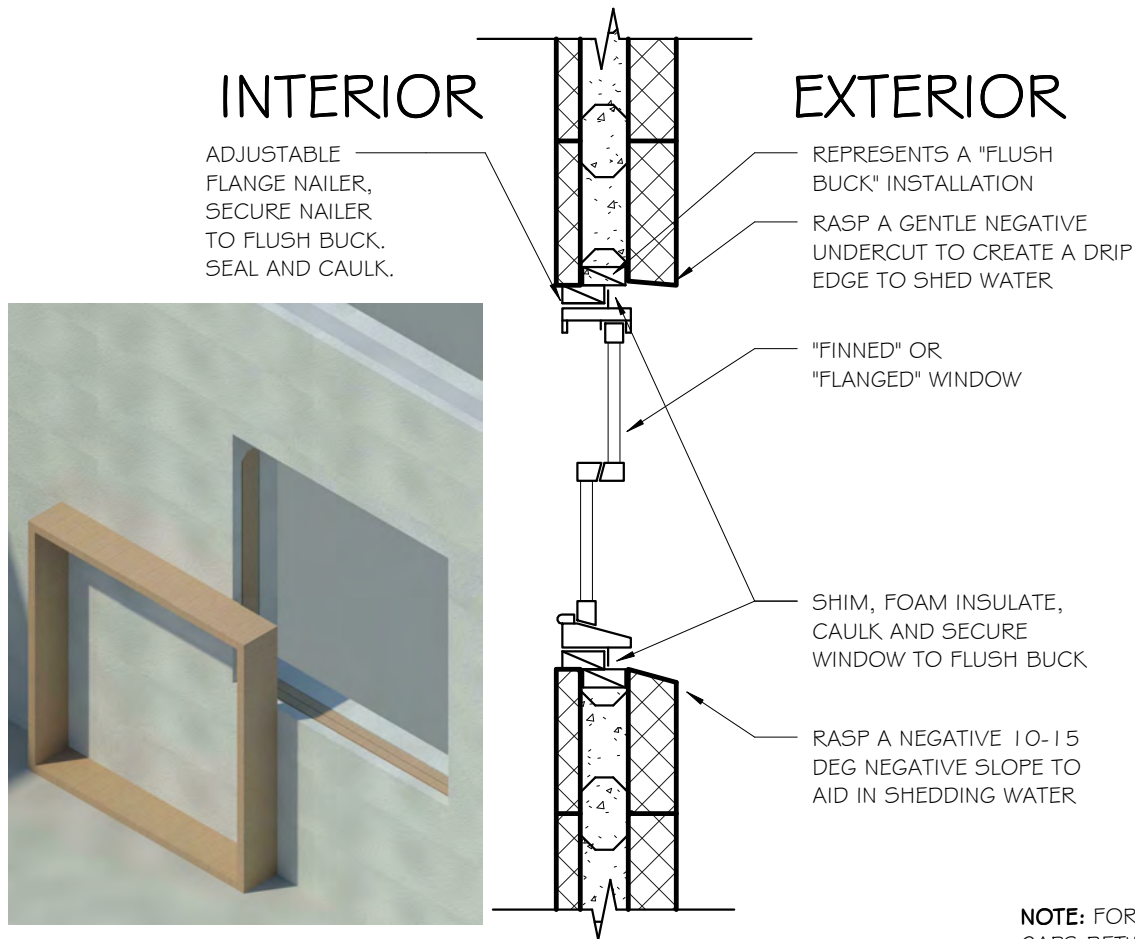

THIS DETAIL REPRESENTS A SECTION VIEW OF THE METHOD 3 (COMBO OF 1 AND 2) BUCK INSTALLATION. THIS METHOD UTILIZES A PT 2X THAT IS ADJUSTABLE WITHIN THE THICKNESS OF THE WALL. IF THE FIN NAILER IS FLUSH WITH THE INTERIOR FACE OF THE WALL, IT CAN BE USED AS A NAILER FOR INTERIOR WINDOW TRIM.

THE ROUGH OPENING WOULD BE LARGE ENOUGH TO FIT A BLOCK FRAME (NO FINS) WINDOW OR A FLANGED WINDOW (AS SHOWN) PLUS A 1/4" FOR SHIMMING.

**NOTE:** FOR STUCCO CLADDING: GAPS BETWEEN THE WINDOW AND ROUGH OPENING CAN BE FILLED WITH SHAPED ICCF PIECES GLUED IN THE VOIDS.

WHEN COATED WITH WATERPROOFING AND FLASHED, THE STUCCO CONTRACTOR WILL COVER FLASHING WITH CHICKEN WIRE AND STUCCO AROUND THE WINDOW.

## COMBO METHOD 1 & 2 WINDOW BUCKING

SCALE: 3/4" = 1'-0"

## **WALL CONSTRUCTION**

### **Builder's Tip:**

This is a personal view/tip from the author about European windows and doors.

When I was stationed in Germany with the USAF almost forty years ago, I was amazed at the window and door technology that I saw all over in Europe. I had not seen anything like it in the US at the time. Nowadays, I still see the windows and doors that are installed in most American new construction to be lacking in design and innovation and still remaining far behind the technology of European windows and doors.

For that reason, I felt it was necessary to provide you some guidance for your research into what windows and doors to install in your project.

Page  
Added  
2/14/25

### **European Windows and Doors for the USA**

Excellent research videos on European imported or domestically manufactured European style windows and doors are available from **Matt Risingers'** very informative YouTube channel: **The Build Show**.

(To view the videos, please copy and paste the URLs below into your computer address block)

#### **How to get better/Cheaper Windows from Europe (to US Job-sites)!**

<<https://buildshownetwork.com/contents/better-cheaper-windows-from-europe>>

#### **Installing European Windows**

<<https://buildshownetwork.com/contents/Installing-European-Windows>>

#### **European Tilt and Turn Windows and Flashing Details**

<[https://buildshownetwork.com/contents/bsb\\_episode\\_6](https://buildshownetwork.com/contents/bsb_episode_6)>

#### **NO FLANGE European Windows**

<<https://buildshownetwork.com/contents/no-flange-european-windows-installation-how-to>>

### **Additional information to research:**

See following page

## **WALL CONSTRUCTION**

### **Builder's Tip:**

#### **European Windows and Doors for the USA**

#### **Additional information to research:**

##### **Alpen**

Colorado company building Euro style window and doors, check out Tyrol models.  
<<https://thinkalpen.com>>

##### **Schuco Windows and Doors**

Skyline Windows

220 East 138th Street

Bronx, NY 10451

[info@skylinewindows.com](mailto:info@skylinewindows.com) <<mailto:info@skylinewindows.com>>

212-491-3000 <<tel:212-491-3000>>

[www.skylinewindows.com](http://www.skylinewindows.com) <<http://www.skylinewindows.com>>

#### **A Small Sample of Suppliers:**

Architectural Windows and Doors

<<https://bieberusa.com>>

European Architectural Supply

<<https://eas-usa.com>>

For more info:

Google keywords: European windows and doors USA

## WALL CONSTRUCTION

### Garage Door Openings

BUILD A TEMPORARY FRAMED WALL TO SUPPORT THE GARAGE DOOR LINTEL PRIOR TO GROUTING WALL

PLACE ANCHOR BOLTS AS DEPICTED BEFORE GROUTING ICCF WALL FOR FUTURE GARAGE DOOR INSTALLATION

FOR ANCHOR BOLT PLACEMENT FOR GARAGE DOOR NAILERS, SEE DETAIL, FIGURE 7.13 ON PAGE 7.13c

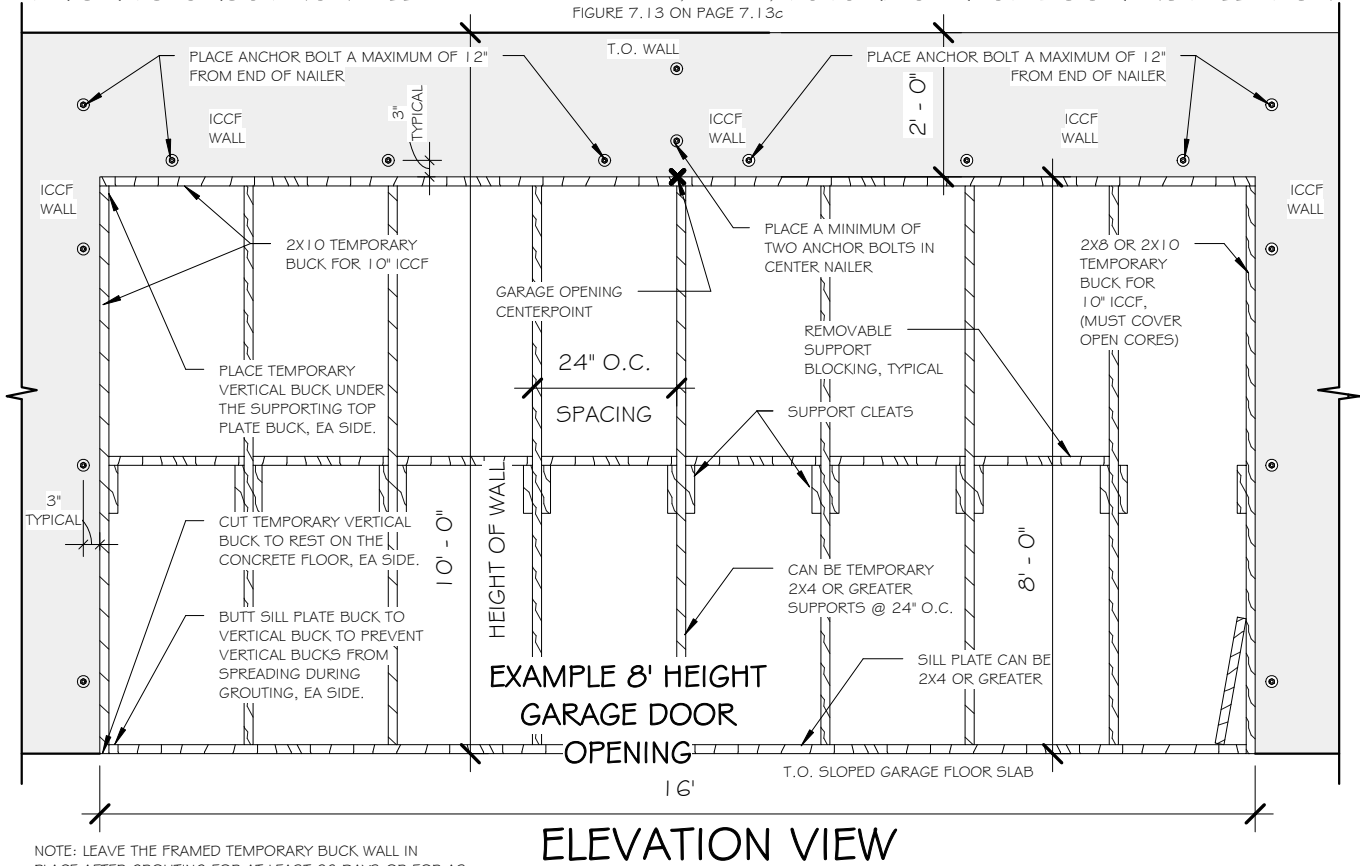

NOTE: LEAVE THE FRAMED TEMPORARY BUCK WALL IN PLACE AFTER GROUTING FOR AT LEAST 28 DAYS OR FOR AS LONG AS POSSIBLE FOR PROPER CONCRETE CURING

## GARAGE DOOR OPENING TEMPORARY BUCK - CONCRETE STOP & LINTEL SUPPORT

Figure 7.13b

## **WALL CONSTRUCTION**

### **Garage Door Openings**





## WALL CONSTRUCTION

### Garage Door Openings

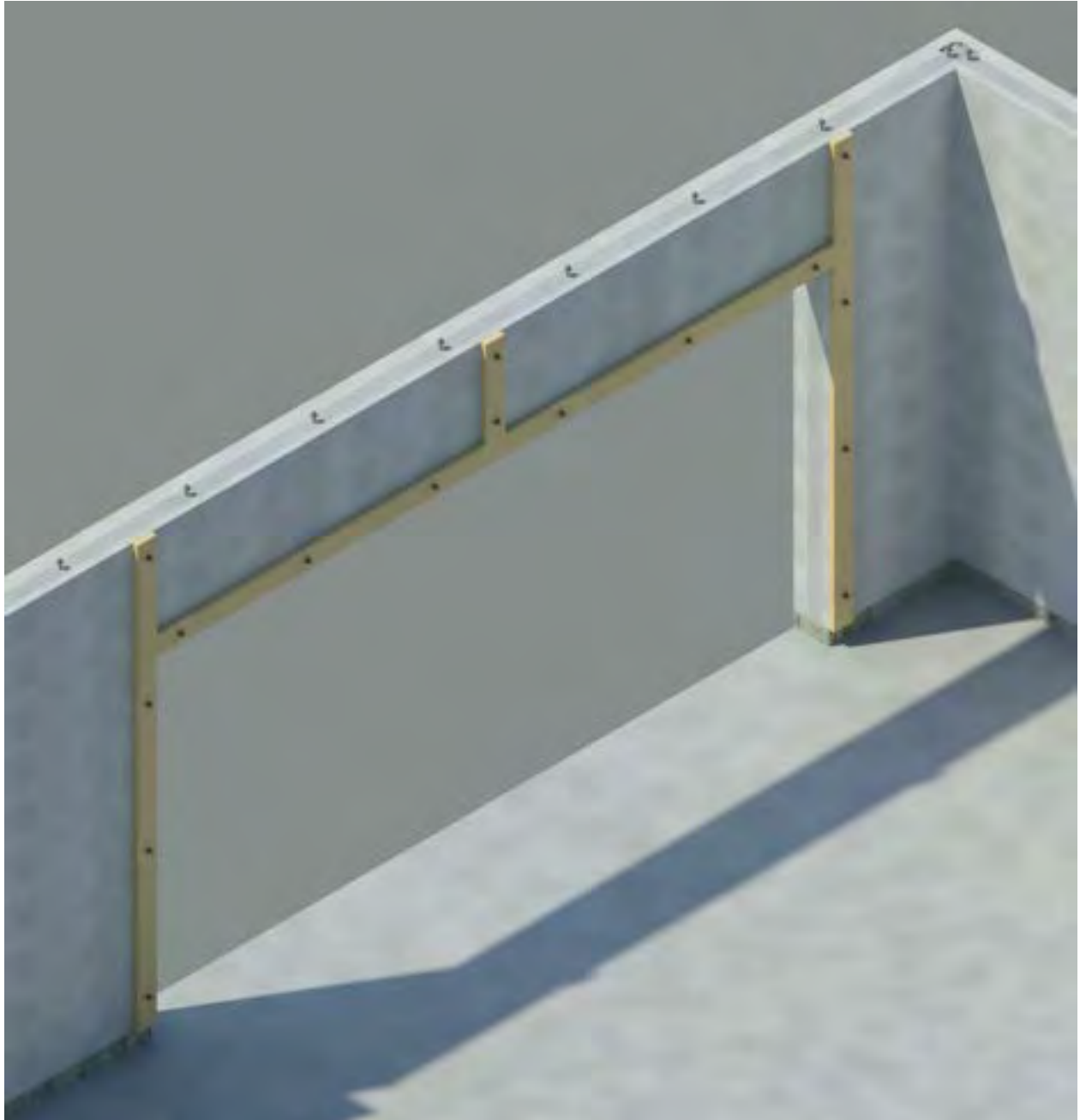

## WALL CONSTRUCTION

### Wall and Lintel Steel Reinforcement Placement for Windows and Doors

The detail below is representative of the reinforcement placement around openings within the an ICCF wall as required by the IRC. A door opening is not shown in the detail, but the reinforcement placement is identical to a window except that the bottom horizontal reinforcement is not applicable.

UPDATED 10/22/19

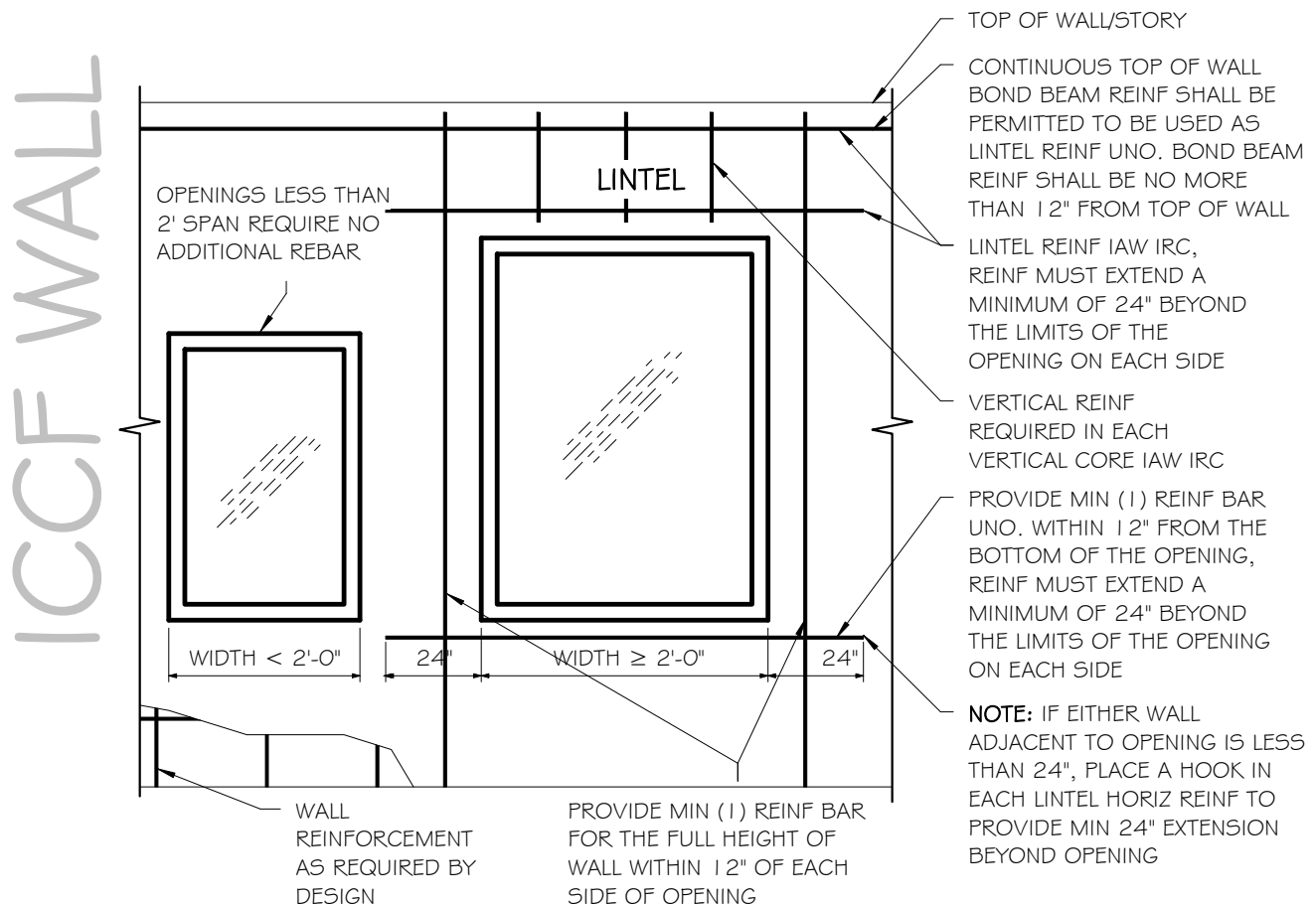

## LINTEL & OPENING ELEVATION, TYPICAL

SCALE: 1/2" = 1'-0"

Figure 7.14a.1

## WALL CONSTRUCTION

### Creating Reinforced Lintels for Spans Over Windows and Doors

Once an opening is finished with the header course of block in place, the opening framed with bucks to stop concrete flow, the lintel rebar should be placed IAW the opening design plan. The following lintel details illustrate the required additional rebar added across an opening span for lintel structural support.

**The following details are only an example of a lintel details for common spans for a single story with roof house. Details for larger spans, multi-floor, additional point loads, etc. in your specific house design may need to be engineered and stamped before use in construction.**

UPDATED 10/22/19

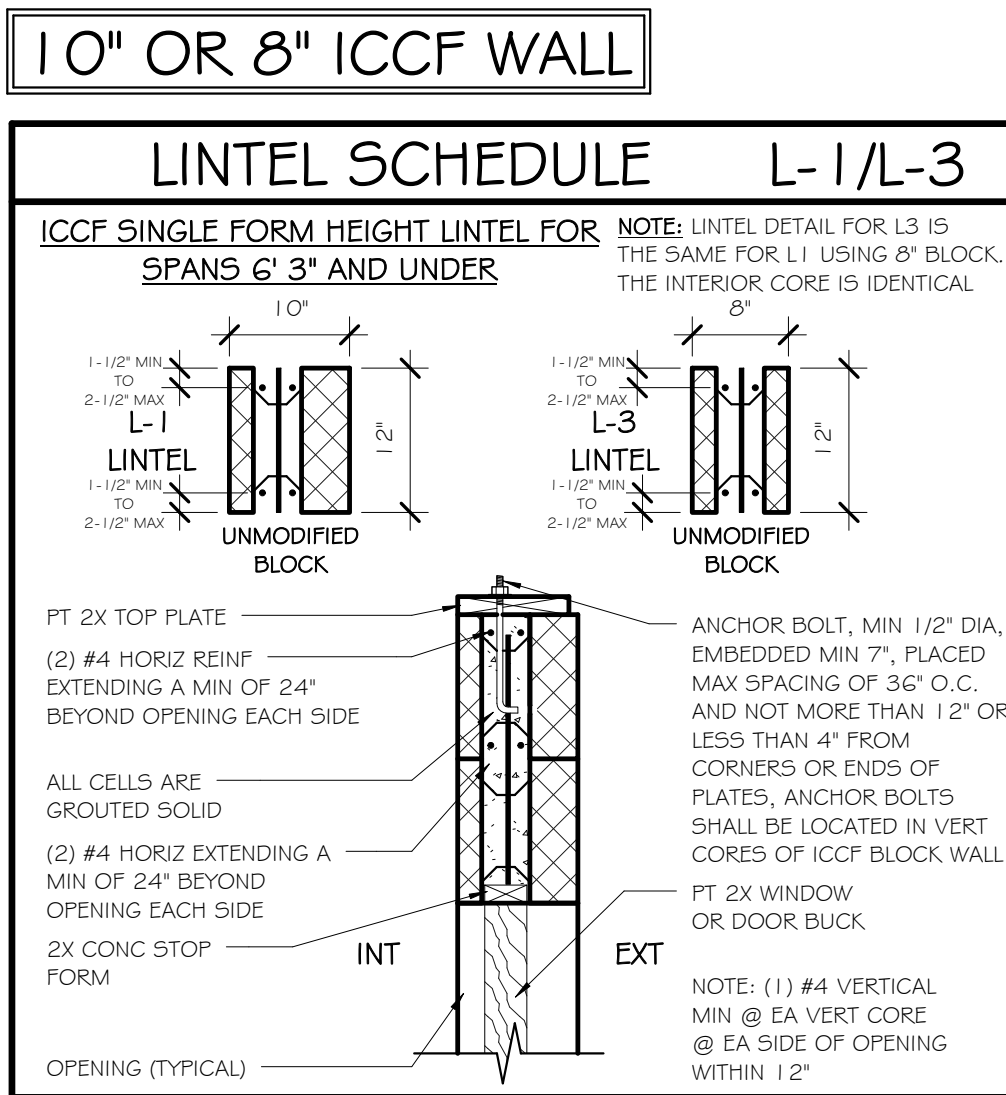

## SINGLE FORM HT LINTEL-SPANS 6'-3 & UNDER

SCALE: 3/4" = 1'-0"

Figure 7.14a.2

## WALL CONSTRUCTION

### Creating Reinforced Lintels (Cont.)

UPDATED 5/24/18

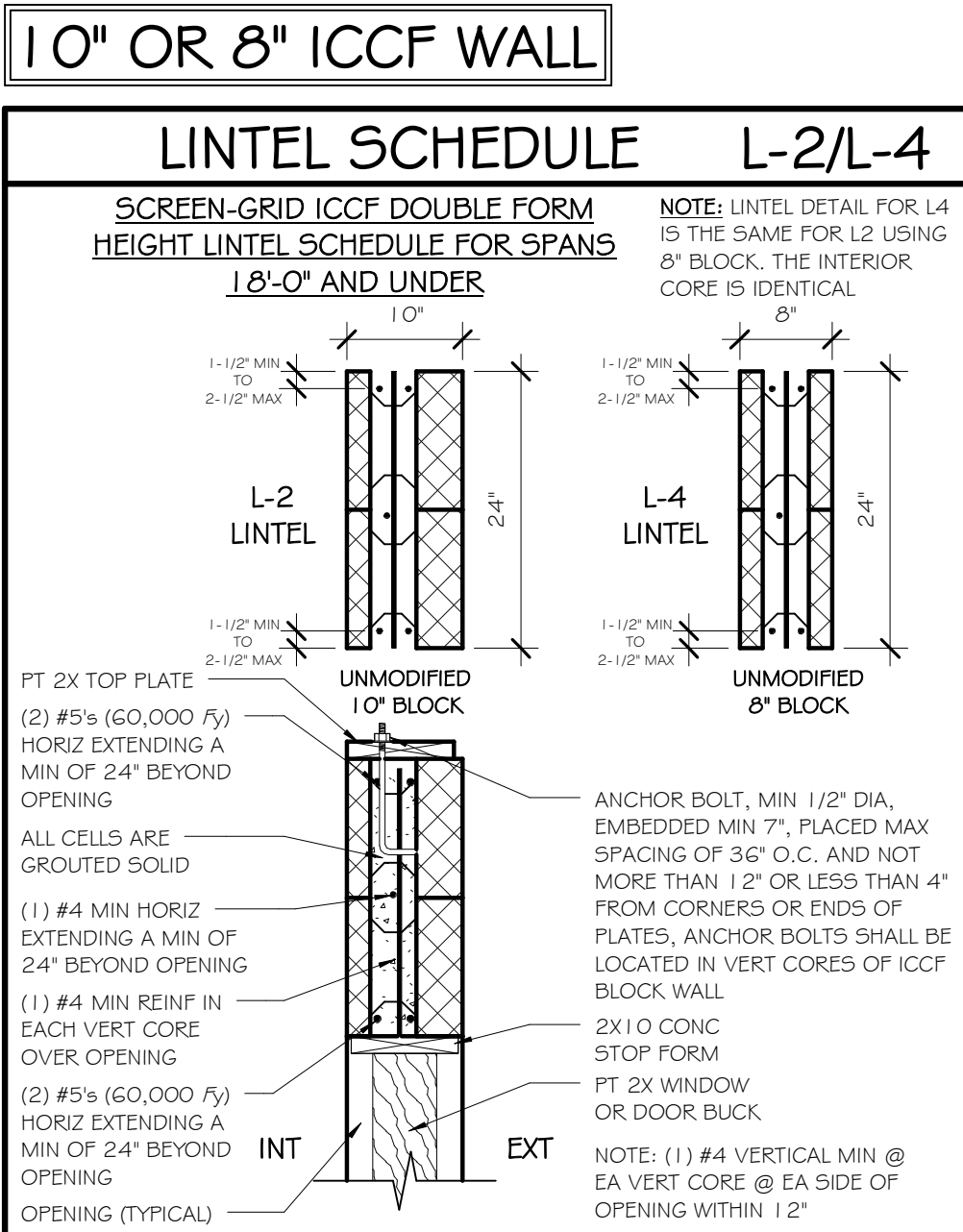

## TWO COURSE HT LINTEL-SPANS 18'-0" & UNDER

SCALE: 3/4" = 1'-0"

Figure 7.14b

## WALL CONSTRUCTION

### Creating Reinforced Lintels (Cont.)

UPDATED 5/18/18

## 10" OR 8" ICCF WALL

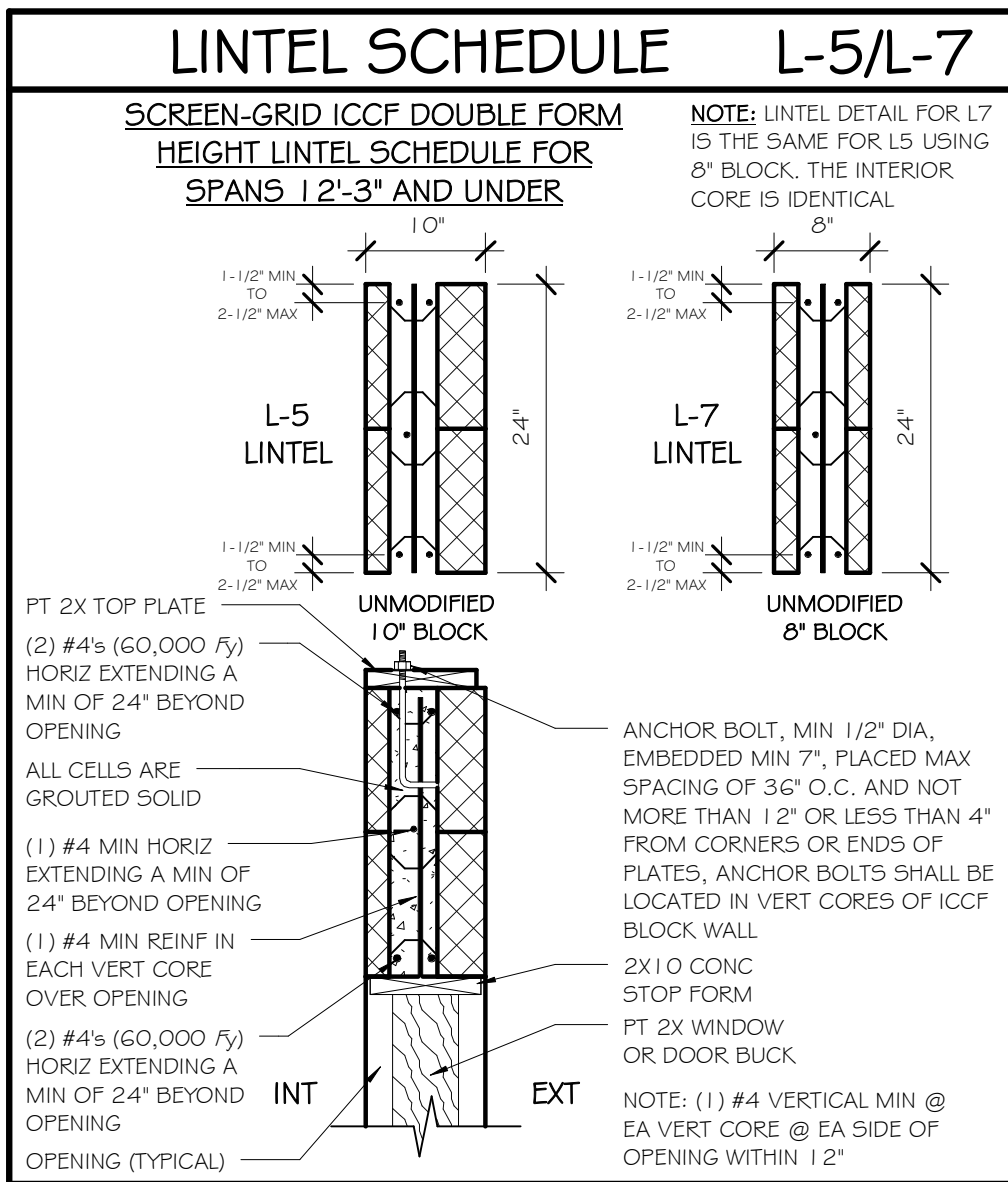

## TWO COURSE HT LINTEL-SPANS 12'-3" & UNDER

SCALE: 3/4" = 1'-0"

Figure 7.15c

## WALL CONSTRUCTION

### Creating Reinforced Lintels (Cont.)

The following details are only an example of a house plan detail for a single story with roof house. All details for a specific house design must be engineered and stamped before use in construction.

UPDATED 5/18/18

## 10" OR 8" ICCF WALL

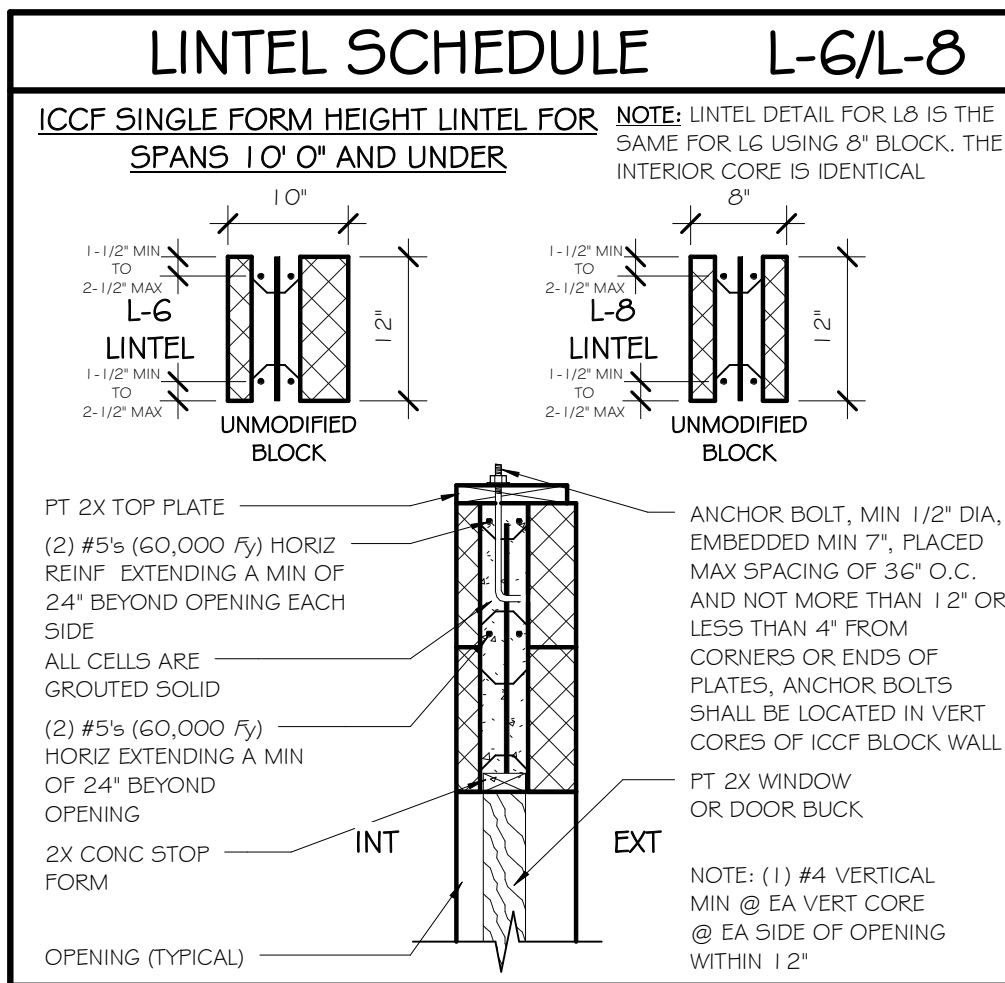

## SINGLE COURSE HT LINTEL-SPANS 10'-0" & UNDER

SCALE: 3/4" = 1'-0"

Figure 7.15d

## WALL CONSTRUCTION

### Creating Reinforced Lintels (Cont.)

The preceding details describe lintel construction for walls tall enough to accommodate windows with window heights that leave 2-3 or more courses of EBS block above the window header height. Designing wall heights and header heights to allow for 2 or more courses of block above opening header heights adds greater flexibility in construction allowing for most openings to be spanned by "unmodified block", reducing time and labor required to modify blocks to create single course lintels. Tall windows and/or short walls (8' walls) may leave only one course of block above the window header height before the top of wall. Depending on the opening to be spanned, significant modification of the top course may be required for structural support. This modification typically requires that the single course of block over the opening be "hogged" out to create a beam of solid reinforced concrete as the lintel. ("Hogged out" is construction slang to describe cutting out the internal webs of an ICCF block to leave a void for solid concrete. Hogged out blocks need significant bracing to withstand the pressures of poured concrete during grouting.) If tall windows and doors in short walls is what you want in your design then plan on spending more time or money or both for that design.

**Builder's Tip:** There are several ways to reinforce blocks that have been weakened by modification to create solid concrete lintels. One method to reinforce these lintels or weakened blocks is suggested below:

1. Cut two pieces of 3/8" thick or greater plywood or OSB sheathing to cover each side of the weakened area.
2. Place one piece of plywood on each side of the block or lintel, and tack in place with clamps or temporary nails.
3. Drill 1/4" or 3/8" holes through both pieces of plywood and block spaced no more than 24 inches apart.
4. Place threaded rod cut to lengths 6-8" longer than thickness of the block in the drilled holes in the plywood and blocks.



## WALL CONSTRUCTION

### Creating Reinforced Lintels (Cont.)

5. Place a scab block of 2X or plywood scrap on each end of the threaded rod with a washer and nut and tighten (tighten only to keep original thickness of the block used, do not overtighten).

Note: Threaded rod is a good way to securely hold the plywood bracing on each side of weakened block. Inexpensive 10' lengths of 1/4" and 3/8" threaded rod can be purchased in the electrical departments of the big box building supply stores. Cut the rods to length and grind each end to a gentle point to make spinning a nut onto the cut ends easier. When the rods have performed their support job during grouting and the grout has hardened but is still green, they should be tapped out and removed along with the bracing. If care is taken to not damage the threaded rods, the rods can be used over and over again. The hole left by the removed rod penetrates the wall to the outside and should be filled with a shot of expanding foam adhesive.

Note: As an alternative to threaded rod, pass through snap ties and metal or wood shoes can be used to keep bracing lumber or ledgers in place prior to grouting. These are available at the concrete supply store.



## WALL CONSTRUCTION

### Adding Ledgers

A ledger placed on the interior or exterior of an ICCF wall is a great method to structurally support a floor or an exterior shed roof. Ledgers can be used to support many different support structures such as joists, TJI's, trusses, beams and girders etc. Interior ledger construction will support your internal structures while leaving the exterior building thermal insulating envelope intact eliminating the common pathways to energy loss found in more traditional construction. Like the interior ledgers, exterior ledgers will support shed roofs, verandas, and patios without sacrificing the building thermal insulating envelope.

### Installing a Ledger

Your structural design will determine the size of ledger and anchor bolt diameter and spacing required to support the design load for your floor or roof. The following suggested construction techniques will be similar for most combinations of ledger design and the following details represent many of the most common methods for constructing ledgers.

A suggested method of ledger construction is as follows:

The techniques discussed will be the same for an exterior or interior ledger. Once your walls are built to the design height of the ledger or above, you can begin to determine the placement of the ledger. Measure and mark the accurate level of the floor or roof. From that finished floor or roof height and accounting for the desired ledger construction and hanger mounting options chosen (i.e. - truss hangers, TJI's, top chord bearing trusses, etc.), measure and mark below that line for the exact level line where the top of the ledger board will be placed. The thickness of floor sheathing and floor finishes and/or the method of support on ("the top of" or "on the face of") the ledger can significantly affect the placement height of the ledger. Do not omit these measurements when calculating your ledger height.

**Builder's Tip:** A laser level is the tool of choice here to simply identify and mark for your ledger heights throughout the building. Alternatives to the laser of course can be a transit or water level.

Snap a chalk line on your walls for each top of ledger board or a convenient "control line" around chest height from which all important heights in your building can be measured (sills, header heights, ledger, top of wall, top of plate, etc.). Now based on the **design required height** (See Builder's Tip on page 7.21) of the ledger and the design size and placement of the anchor bolts mark the center of each 6" diameter hole that will be needed to be cut into the wall below your level line for each anchor bolt. Note: Placement of the holes for the anchor bolts must be aligned with a vertical core (12" on center) within the ICCF block to ensure proper concrete embedment for each anchor bolt during concrete grouting. In some cases, your anchor bolt alignment may coincide with a horizontal core in the block wall. In this case, anchor bolt alignment with block vertical cores is not required but is still recommended.

## WALL CONSTRUCTION

### Installing a Ledger (Cont.)

A good technique (and our preferred method) for ledger construction, is to "buck" those holes with OSB. Once the 6" diameter holes are accurately cut in your ICCF walls to imbed the anchor bolts that will eventually support your ledgers, cut 1/2" to 3/4" OSB sheathing to the height size of the ledger to be used (you can use double thicknesses of thinner OSB to add stiffness and lower costs). Place the OSB, as if it were the ledger at the level line you marked for the ledger height. Accurately drill holes in the OSB to hold the anchor bolts properly in the holes in the ICCF wall at the proper imbedment depth. The OSB "buck", with the anchor bolts installed, needs to be secured in place with threaded rods and nuts and washers, through the ICCF wall, spaced appropriately 36" O.C., depending on the thickness of the OSB buck) to hold back the wet concrete during grouting.

After the concrete has hardened, the OSB and the threaded rod can be removed and the OSB buck can be placed on the ledger as an accurate template to precisely drill the holes in your ledger for the anchor bolts imbedded in the grout.



**OSB buck with anchor bolts at mid height on an ICCF wall.**

**Builder's Tip:** Drill the hole for the threaded rod for holding the buck, aligned with an ICCF web. This will ensure that the threaded rod can be tapped out after the concrete hardens and won't be anchored in the grout and can be used again and again. Once the buck is removed, shoot some spray foam in the rod hole to plug it.

Another technique for installing ledgers, is to use the ledger itself as the "buck" to hold back the concrete in your ICCF wall. (This method may be a bit more labor intensive due to the greater size and weight of placing and supporting a 3x wood ledger). Drill the 6" diameter holes for the anchor bolts accurately in the ICCF wall. Drill the proper diameter holes in your ledgers and place the anchor bolts with nuts and washers in the ledger before mounting the ledgers on the wall. The ledger becomes the form or "buck" to hold the anchor bolts in the proper position for grouting and provides the blocking necessary to prevent concrete flow through the wall holes during grouting. As with the OSB method above, threaded rod must be used to secure the ledger in its proper place before the concrete is poured. When the concrete hardens, tighten the anchor bolt nuts and the joists or trusses are ready for hanging.

## WALL CONSTRUCTION

### Installing a Ledger (Cont.)

#### A-FRAME LEDGER SUPPORT

UPDATED 01/08/20

ONCE THE TOP OF THE LEDGER IS ACCURATELY LEVELED WITH THE T.O. LEDGER CHALK LINE AND SECURELY SUPPORTED BY A-FRAMES, DRILL A MINIMUM OF TWO HOLES THROUGH LEDGER AND WALL NEAR EACH END OF LEDGER AND PLACE 1/4" - 3/8" THREADED ROD WITH NUTS AND WASHERS THROUGH LEDGER AND WALL WITH A SCRAP SCAB BLOCK ON OTHER SIDE OF WALL AND SECURELY TIGHTEN. (IT IS PREFERABLE THAT THE THREADED ROD HOLES ARE PLACED THROUGH A BLOCK WEB AND NOT THROUGH A VERTICAL OR HORIZONTAL CORE WHERE IT WILL ENCOUNTER CONCRETE DURING GROUTING. THE THROUGH HOLES CAN BE PLUGGED WITH SPRAY FOAM AFTER SUPPORT BREAKDOWN WHEN CONCRETE HAS HARDENED).

NOTE: PASS THROUGH SNAP TIES AND SHOES CAN BE USED AS AN ALTERNATIVE TO THREADED ROD.

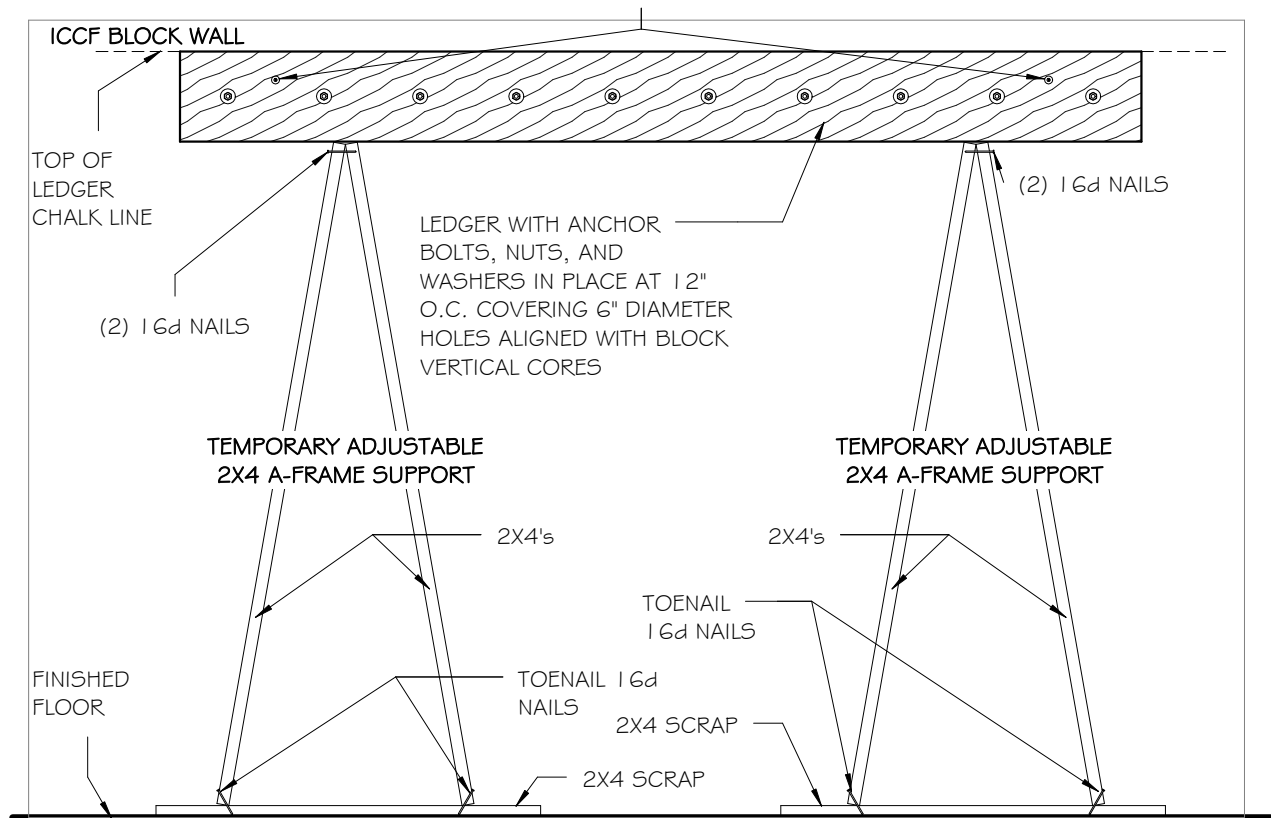

Figure 7.15

## ICCF WALL LEDGER A-FRAME SUPPORT

SCALE: 1/2" = 1'-0"

## WALL CONSTRUCTION

### Installing a Ledger (Cont.)

Once the top of the ledger is accurately determined based on the desired finished floor height and type and method of support for the floor, cut 6" diameter holes (code) that your anchor bolts will be placed and held into position by an OSB or plywood "buck" cut to the same height as the ledger board that you will use. (the holes can be cut with a keyhole saw if you don't have a 6" diameter hole saw bit).

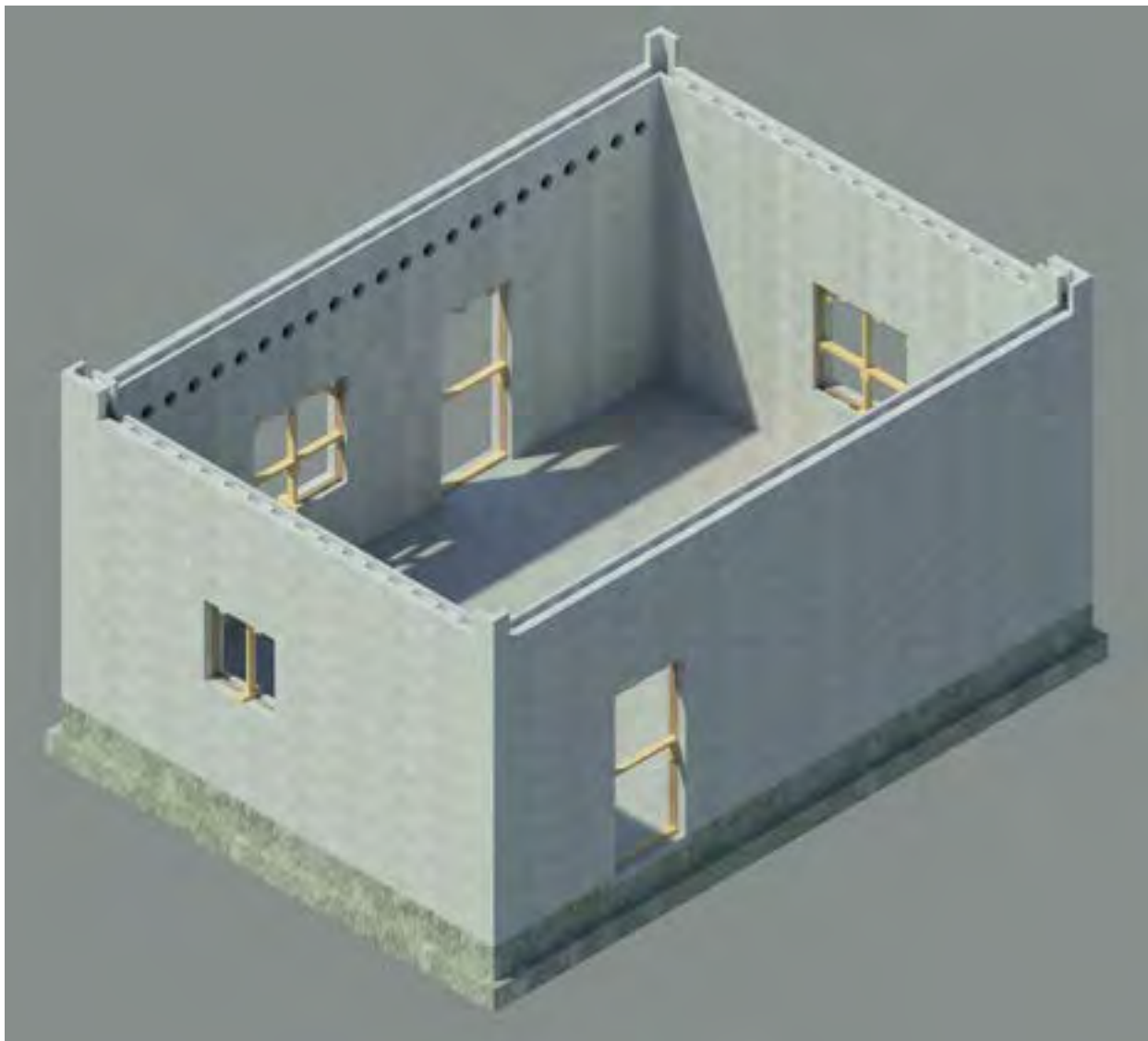
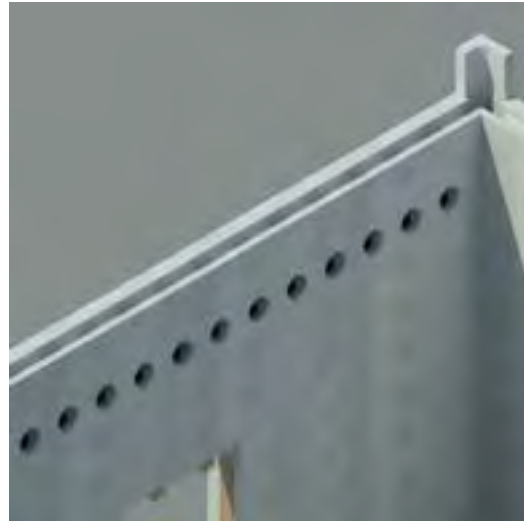

## WALL CONSTRUCTION

### Installing a Ledger (Cont.)

The ledger "buck" is cut to the height of the ledger and holes drilled at the diameter of the anchor bolts (AB) to tightly hold the AB's at the center of the holes in the wall and at the depth for proper embedment and exposure to hold the ledger. The buck is held in its proper place with threaded rod, (1/4" or 3/8" diameter) bolted through the ICCF wall at 36" on center until the wall is fully grouted and the AB's are concreted in place. After grout, take off the buck and use it as a template for accurately drilling the mounting holes in the ledger. Mount the ledger on the wall.

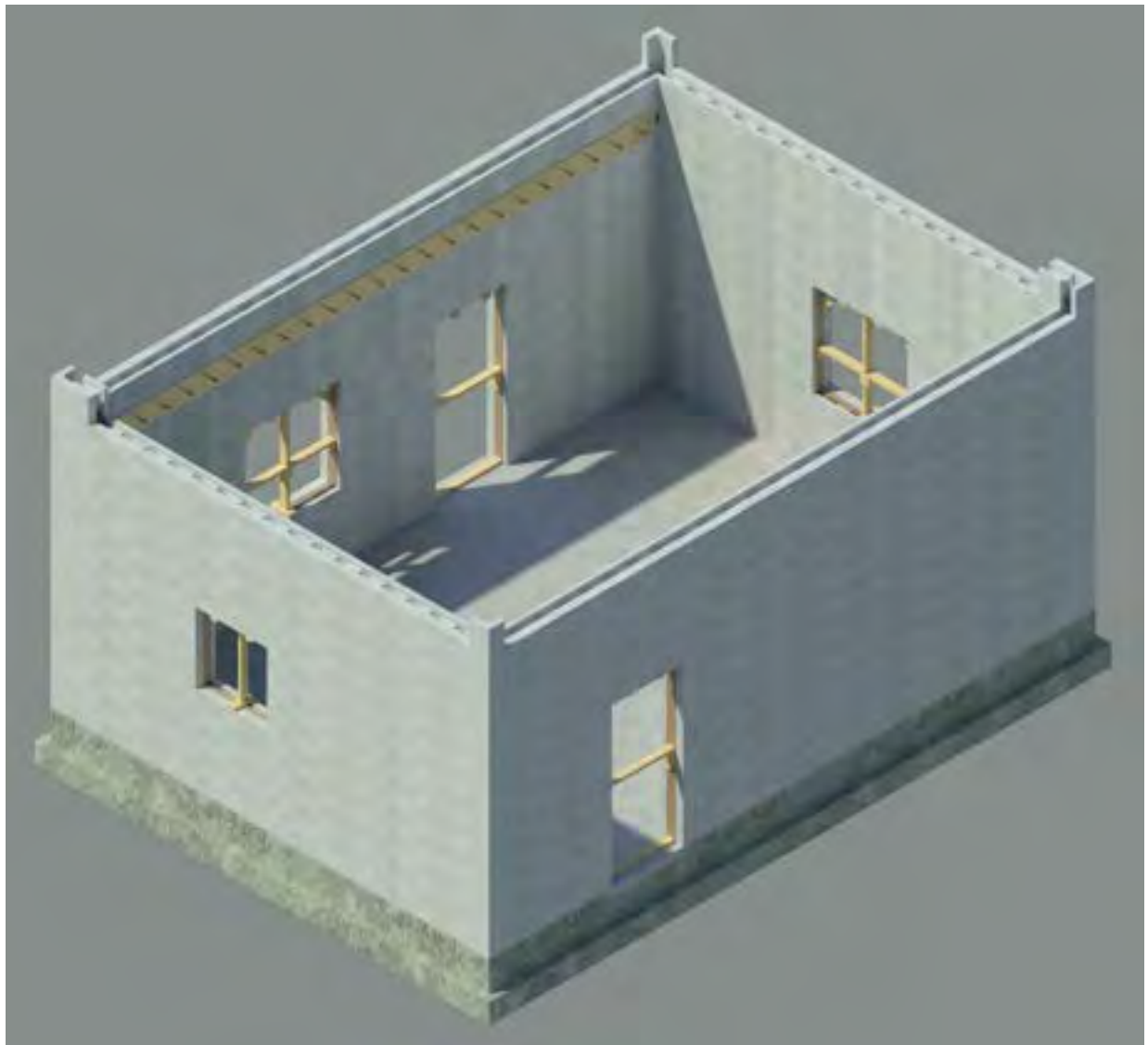
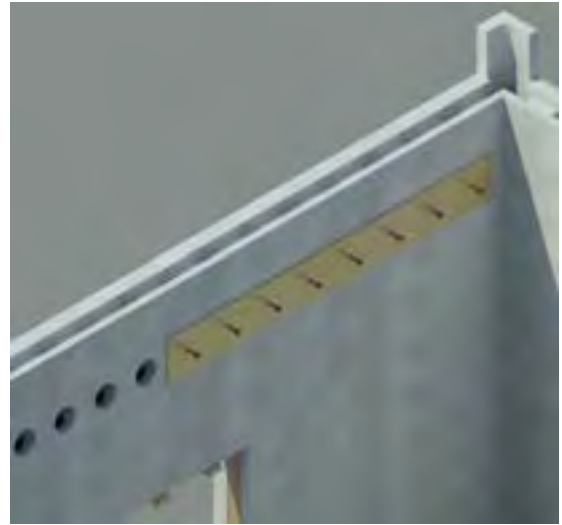

## **WALL CONSTRUCTION**

### **Installing a Ledger (Cont.)**

This is a view of the ledger buck removed and the anchor bolts concreted into the wall.



## **WALL CONSTRUCTION**

### **Installing a Ledger (Cont.)**

This is a view of a 3x12 ledger board installed on the wall.



## **WALL CONSTRUCTION**

### **Installing floor trusses**

This is a view of the beginning of installing top chord bearing, open web floor trusses at 16" on center on the 3x12 ledger board installed on the wall.

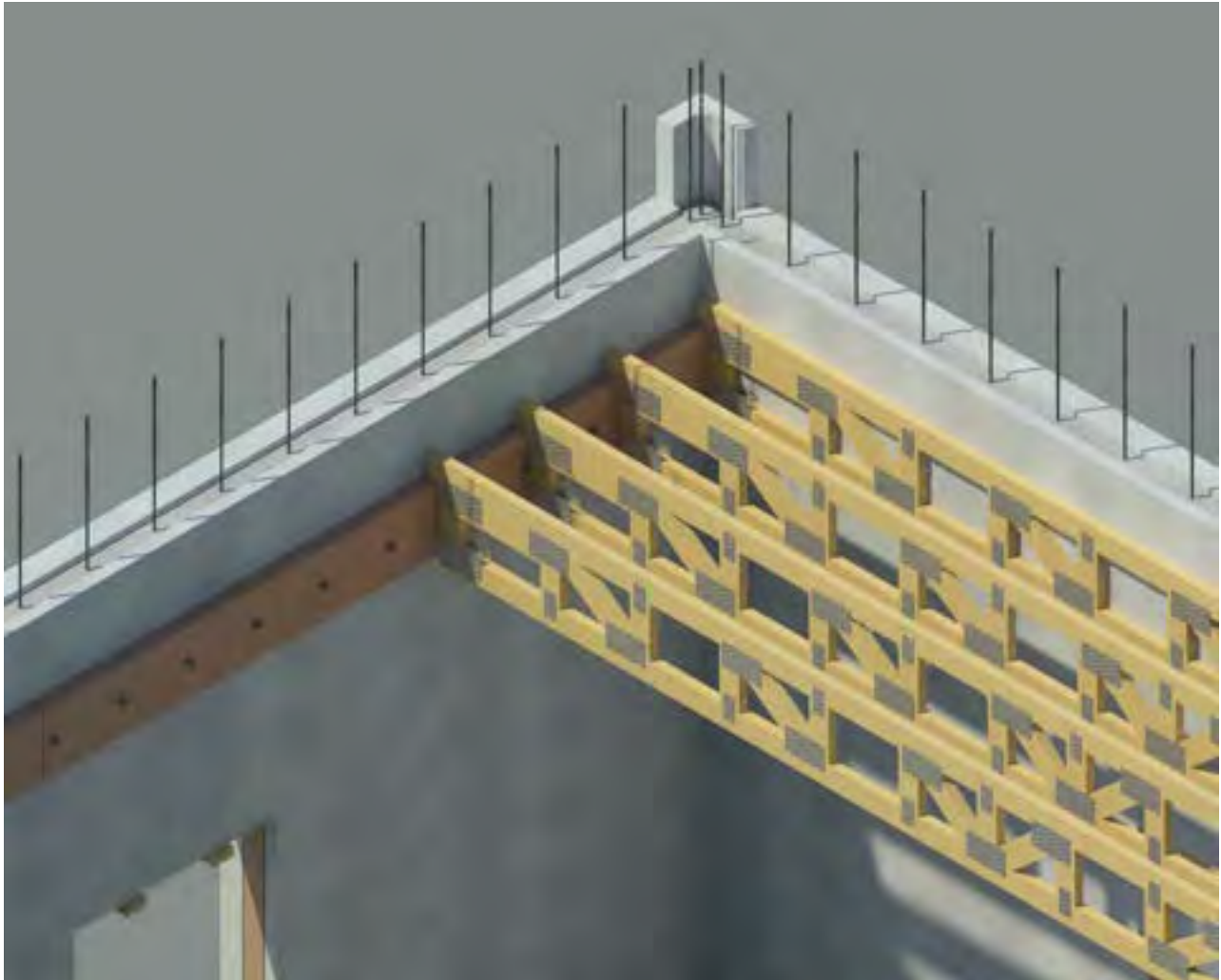

## **WALL CONSTRUCTION**

### **Installing floor trusses (Cont.)**

Installation of the second floor trusses is complete. From this point in construction, the floor sheathing can be installed.



## **WALL CONSTRUCTION**

### **Installing floor sheathing**

This is the beginning of the installation of the second floor sheathing on the floor trusses.

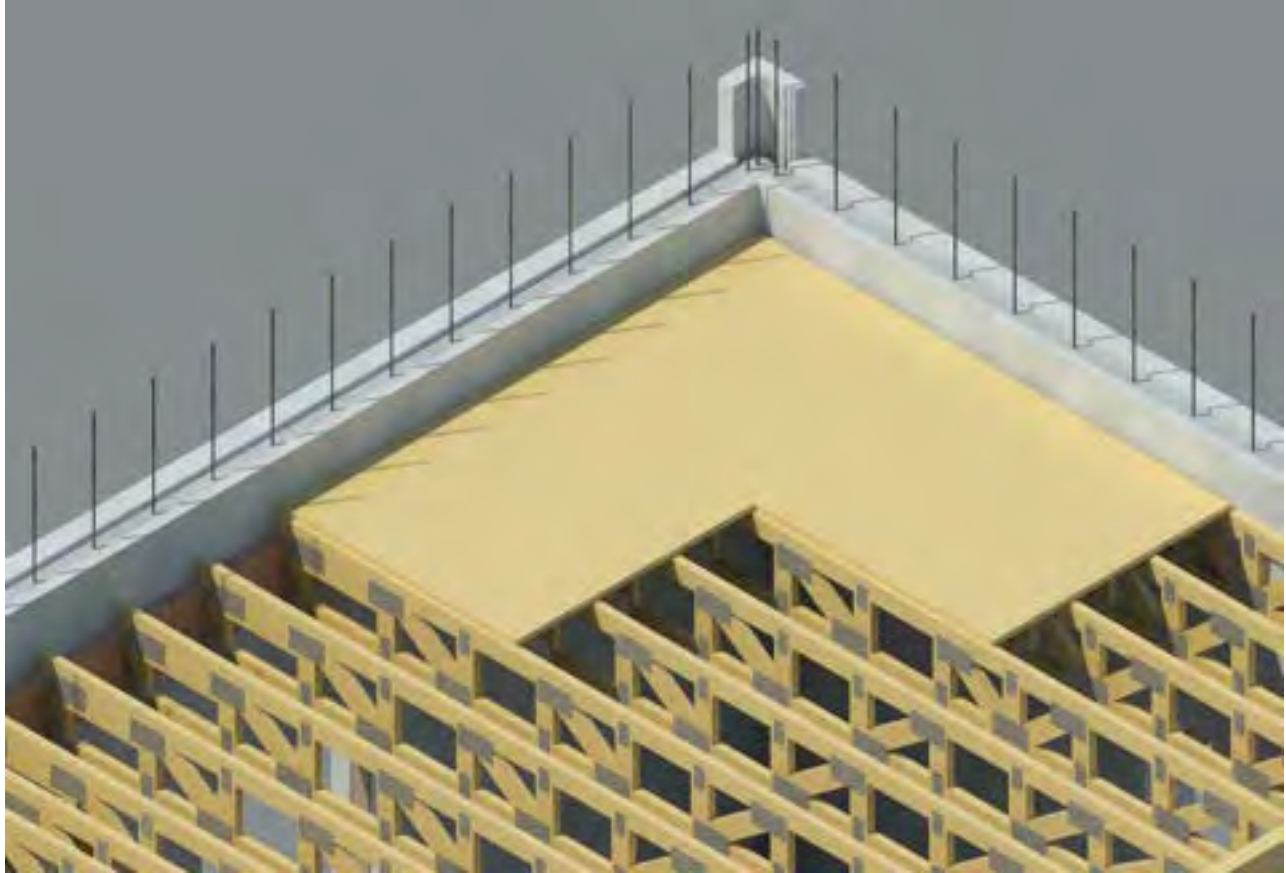

## **WALL CONSTRUCTION**

### **Installing floor sheathing (Cont.)**

Once the floor sheathing is complete, work installing the second floor ICCF wall blocks can begin. Be certain that all hazards, like the stairwell opening, is safely covered or adequate borders are in place before beginning wall construction.

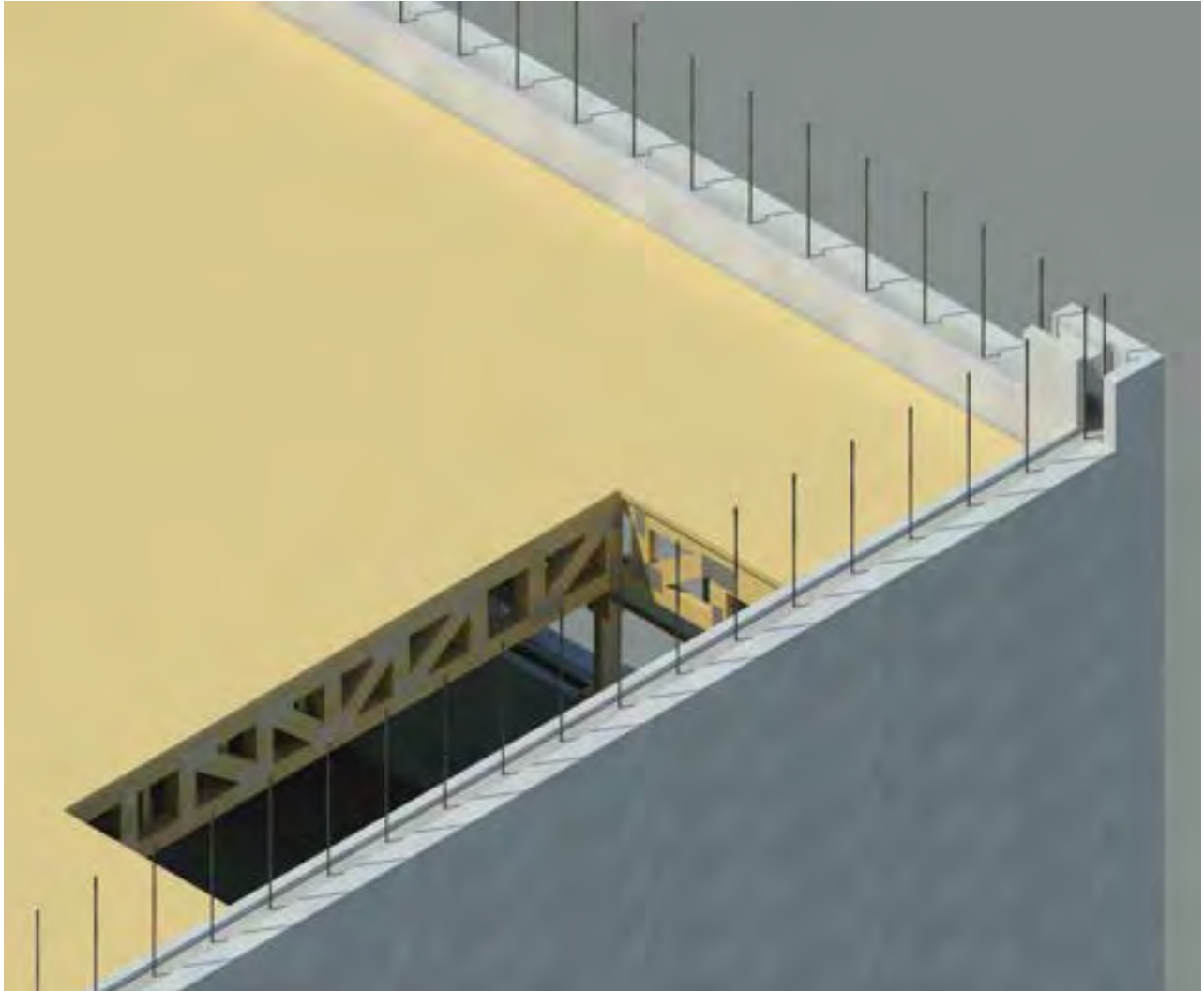

## WALL CONSTRUCTION

### Installing a Ledger (Cont.)

The following details show some typical construction methods and materials when using ledgers on EBS walls to support a floor or roof.

#### SINGLE BOLT LEDGER ANCHOR BOLT / 12" O.C.

UPDATED 5/18/18

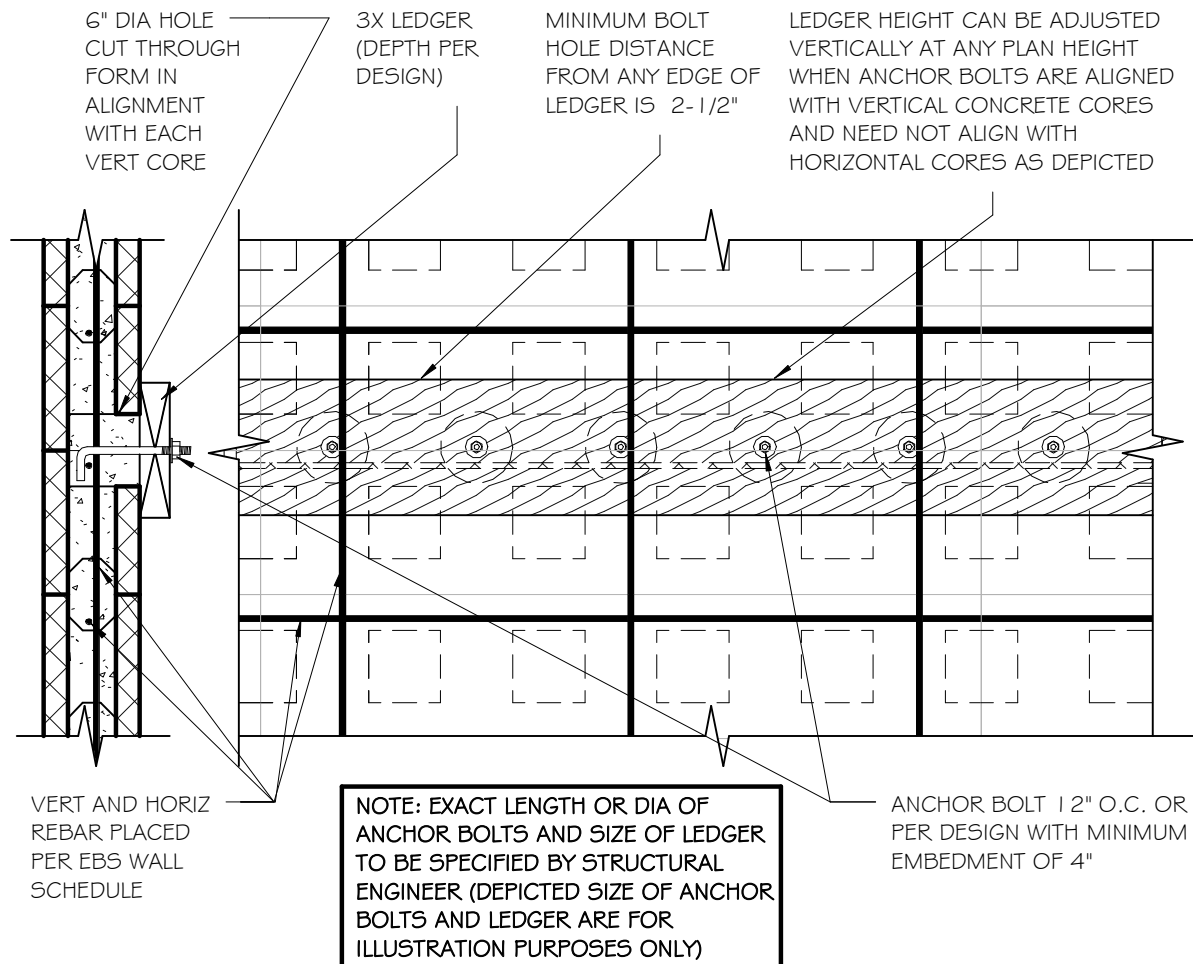

CLARIFICATION NOTE: ALTHOUGH NOT DEPICTED IN THE DETAIL, IT IS SUGGESTED THAT STAGGERING CONSECUTIVE ANCHOR BOLT HOLES VERTICALLY AN INCH OR TWO WITHIN THE BLOCK HOLE CAN AID IN MINIMIZING THE LEDGER BOARDS FROM CUPPING OR HELP PREVENT GENERATING A CENTRAL CRACK.

## LEDGER - SECTION AND ELEVATION

SCALE: 3/4" = 1'-0"

Figure 7.16

## WALL CONSTRUCTION

### Installing a Ledger (Cont.)

**Builder's Tip:** (Reference text on page 7.18) Design Required Height of a ledger is a critical measurement. If the height of your finished floor is to be accurately achieved then many things must be considered when placing your ledger that supports that floor on your walls. You must calculate the height of the top of the ledger to accommodate the type of truss or joist used and the method of bearing support used: ( i.e, top chord bearing or truss hanger) and the thickness of the floor sheathing. Careful planning at this stage will ensure your floor will be right where you want it.

UPDATED 5/18/18

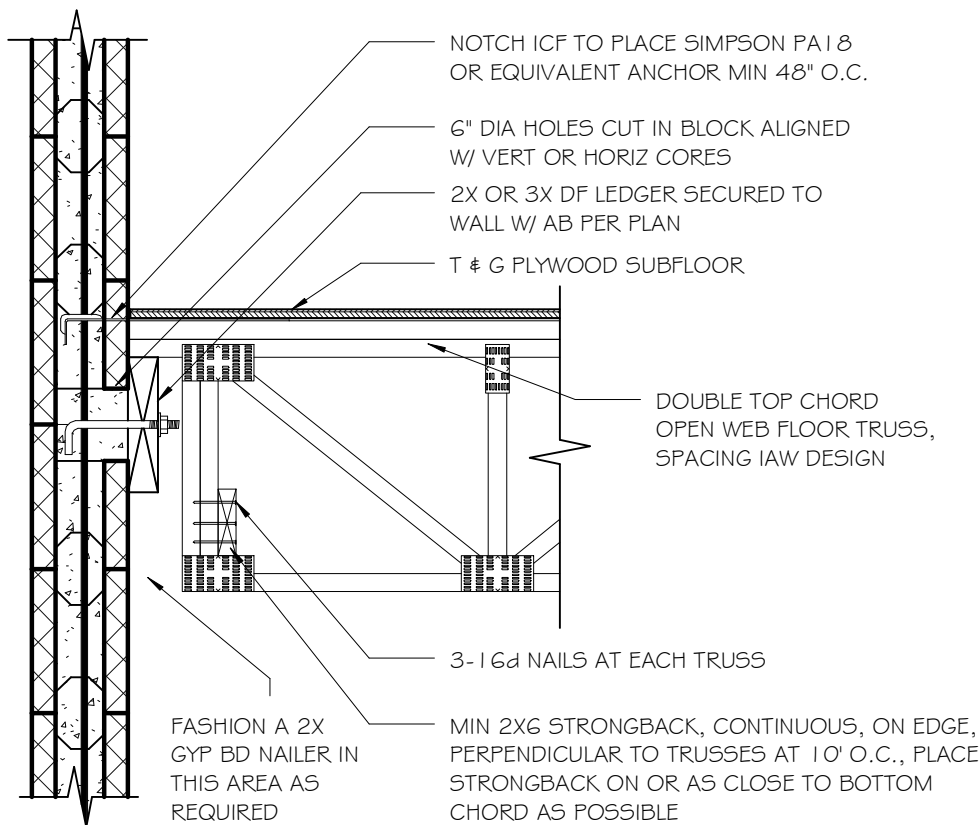

## LEDGER - DOUBLE TOP CHORD BRG/TRUSS

SCALE: 3/4" = 1'-0"

Figure 7.17

## WALL CONSTRUCTION

### Installing a Ledger (Cont.)

UPDATED 5/18/18

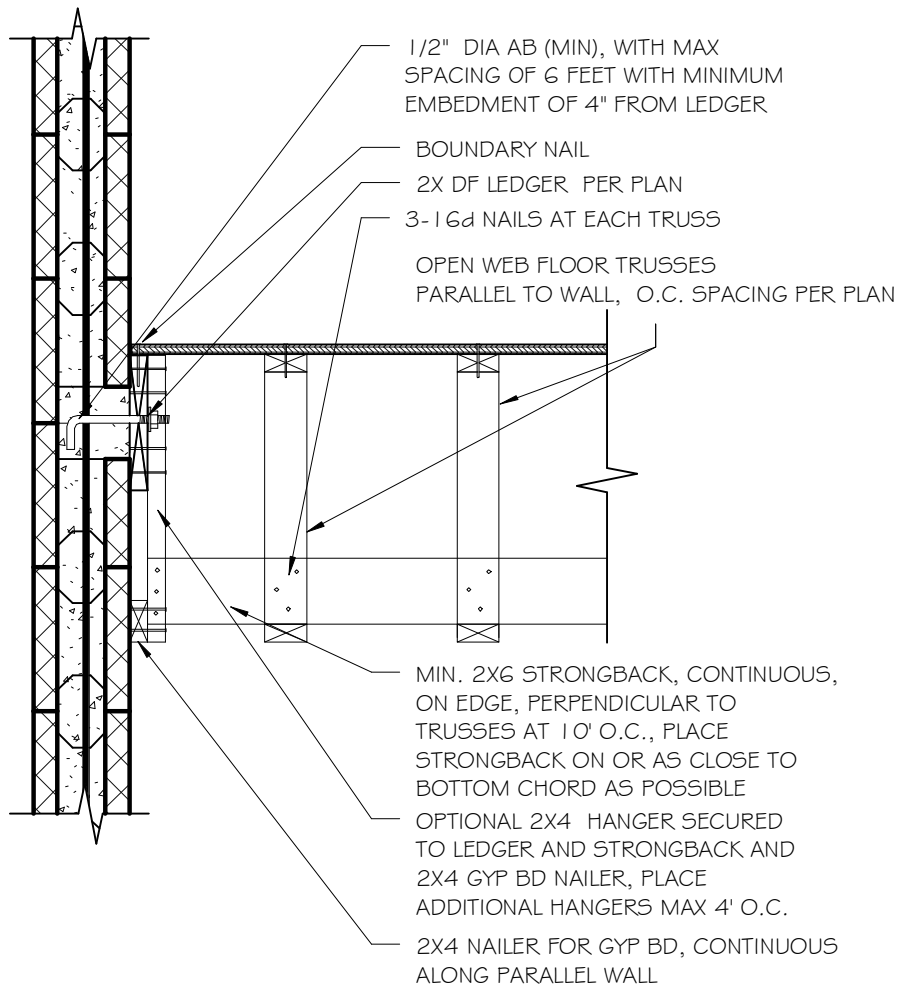

## LEDGER - TO PARALLEL TRUSS

SCALE: 3/4" = 1'-0"

Figure 7.18

## WALL CONSTRUCTION

### Installing a Ledger (Cont.)

UPDATED 2/20/23

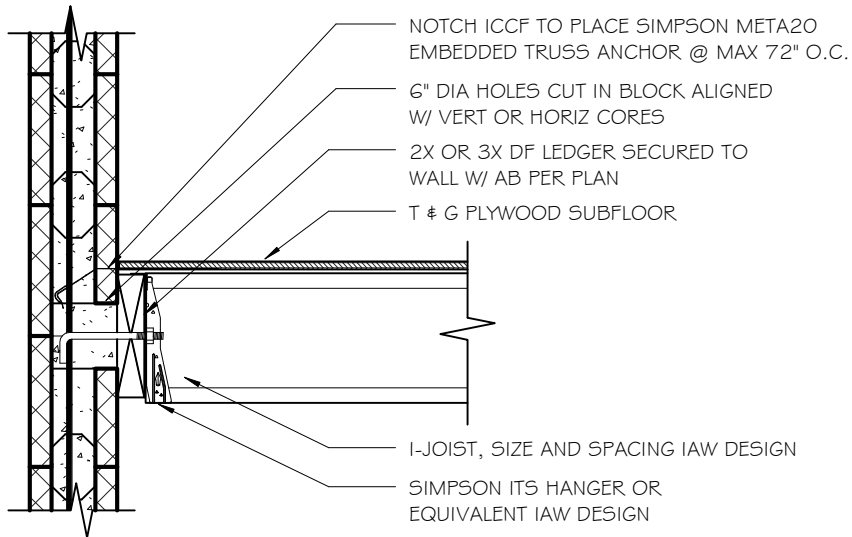

## LEDGER - TO I-JOISTS

SCALE: 3/4" = 1'-0"

Figure 7.19

## WALL CONSTRUCTION

### Adding a Ledger (Cont.)

UPDATED 5/18/18

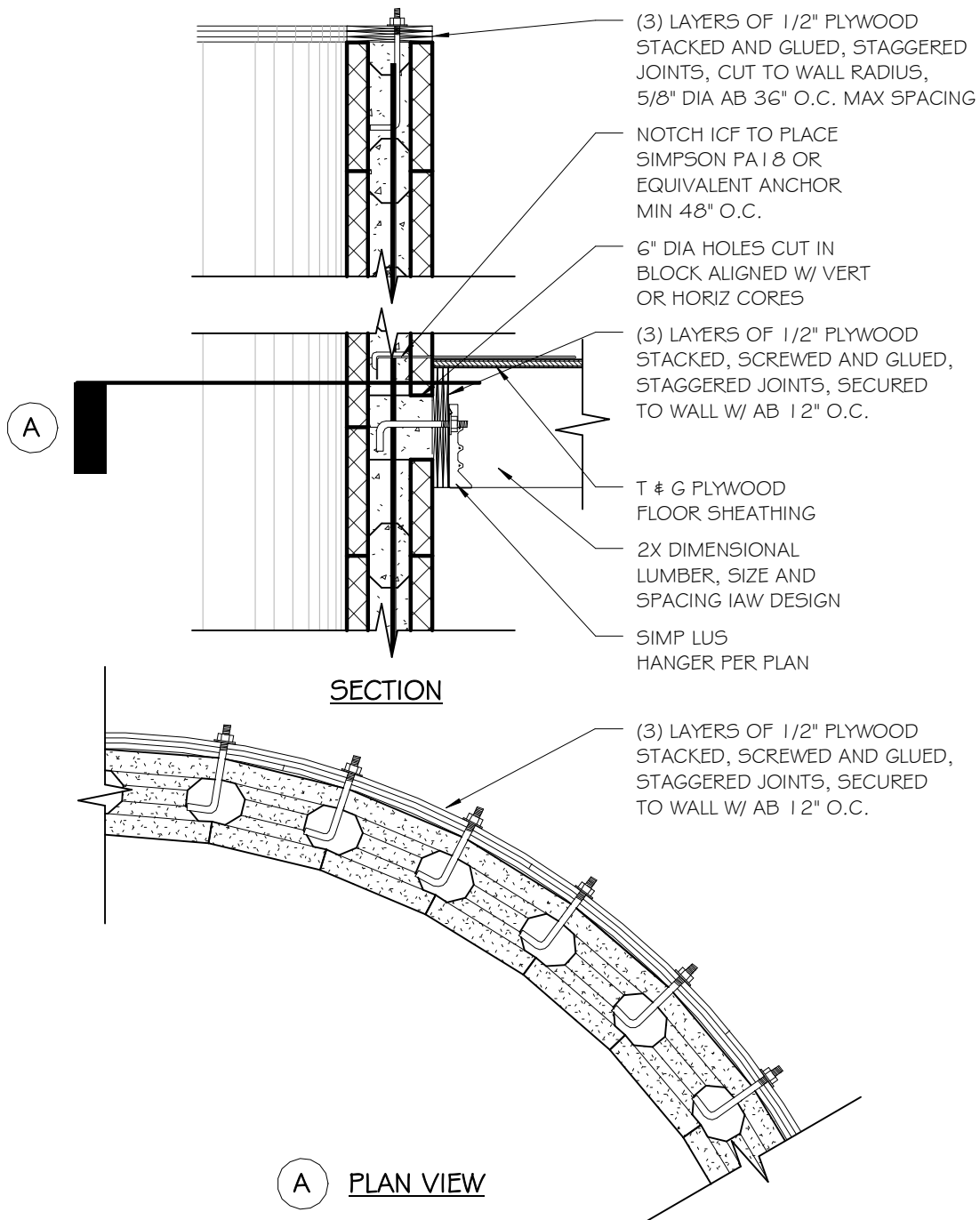

## LEDGER - RADIUS WALL & TOP PLATE

SCALE: 3/4" = 1'-0"

Figure 7.20

## WALL CONSTRUCTION

### Installing a Top Chord Bearing Truss in a Wall Pocket (No Ledger)

The following detail shows a typical construction method creating a bearing pocket within the interior face and internal core of the ICCF block to support top chord bearing trusses or (with a larger pocket) butt end floor or roof trusses in lieu of using an installed ledger for truss support.

The bearing pocket is created by placing a "buck", the size of the pocket needed within the wall at the appropriate truss spacing interval prior to grouting wall with concrete. Many different straps or tie-holdown anchors or purlin anchors may be installed when placing the bucks, to be embedded into the concrete when poured. After grouting, remove the bucks and install the trusses and secure straps or tie-holdown anchors or purlin anchors to trusses.

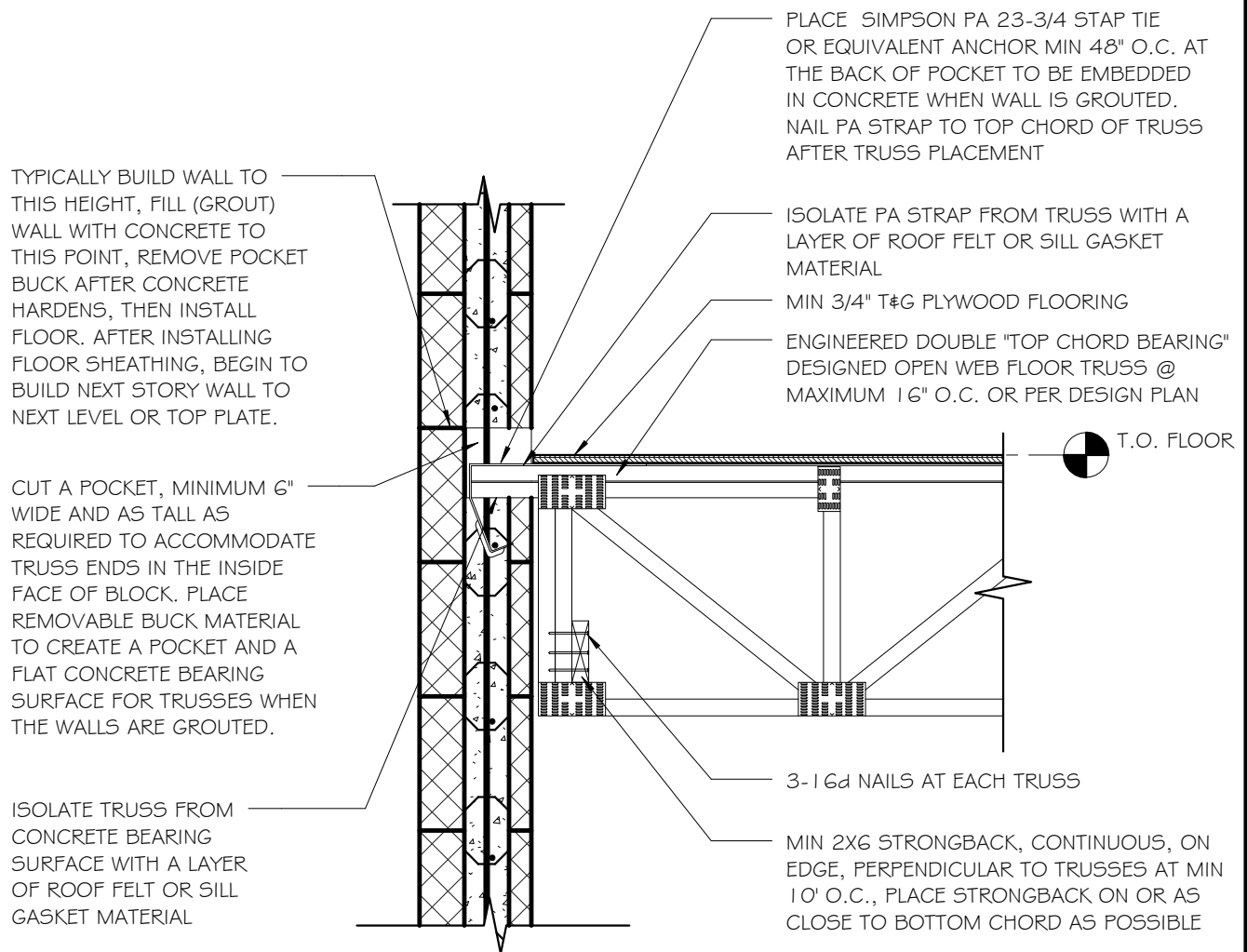

Added  
3/23/21

## WALL POCKET-TOP CHORD BRG TRUSS INSTALLATION

SCALE: 3/4" = 1'-0"

## **WALL CONSTRUCTION**

### **Bracing the Walls**

Only minimal bracing of ungrouted EBS block walls during or after erection is necessary to minimize the chances of a wall being damaged by high winds or the effects of pouring heavy wet concrete during grouting. Fortunately the precision design of EBS blocks along with proper gluing and wall construction will minimize the need for excessive bracing.

Details on the following pages illustrate some suggested temporary bracing methods for straight ungrouted walls.

Note: It is likely that you will be grouting your walls from the interior of your structure as recommended by EBS. Every effort should be made to brace your walls on the exterior side of your structure to eliminate the need to maneuver scaffolding and pump hoses and interior braces during the grouting phase.

### **Pre-grout Bracing Inspection**

Before concrete is poured, inspect the walls for adequate bracing. The following locations are vulnerable to failures if not properly braced:

- a) Exterior and interior corners
- b) Window and door buck supports
- c) Areas around windows and doors with blocks that have been cut leaving unsupported core flanges
- d) Blocks modified for cutouts for pipe, conduit, or other areas
- e) Free standing or dead end walls
- f) Long straight walls
- g) Wide lintel spans

Important Note: Check wall plumb and alignment during your bracing inspection. If necessary, push or pull the walls into plumb and alignment with your bracing prior to grouting.

## WALL CONSTRUCTION

UPDATED 9/23/20

### Bracing the Walls (Cont.)

#### TYPICAL TEMPORARY PRE-GROUT BRACING METHOD

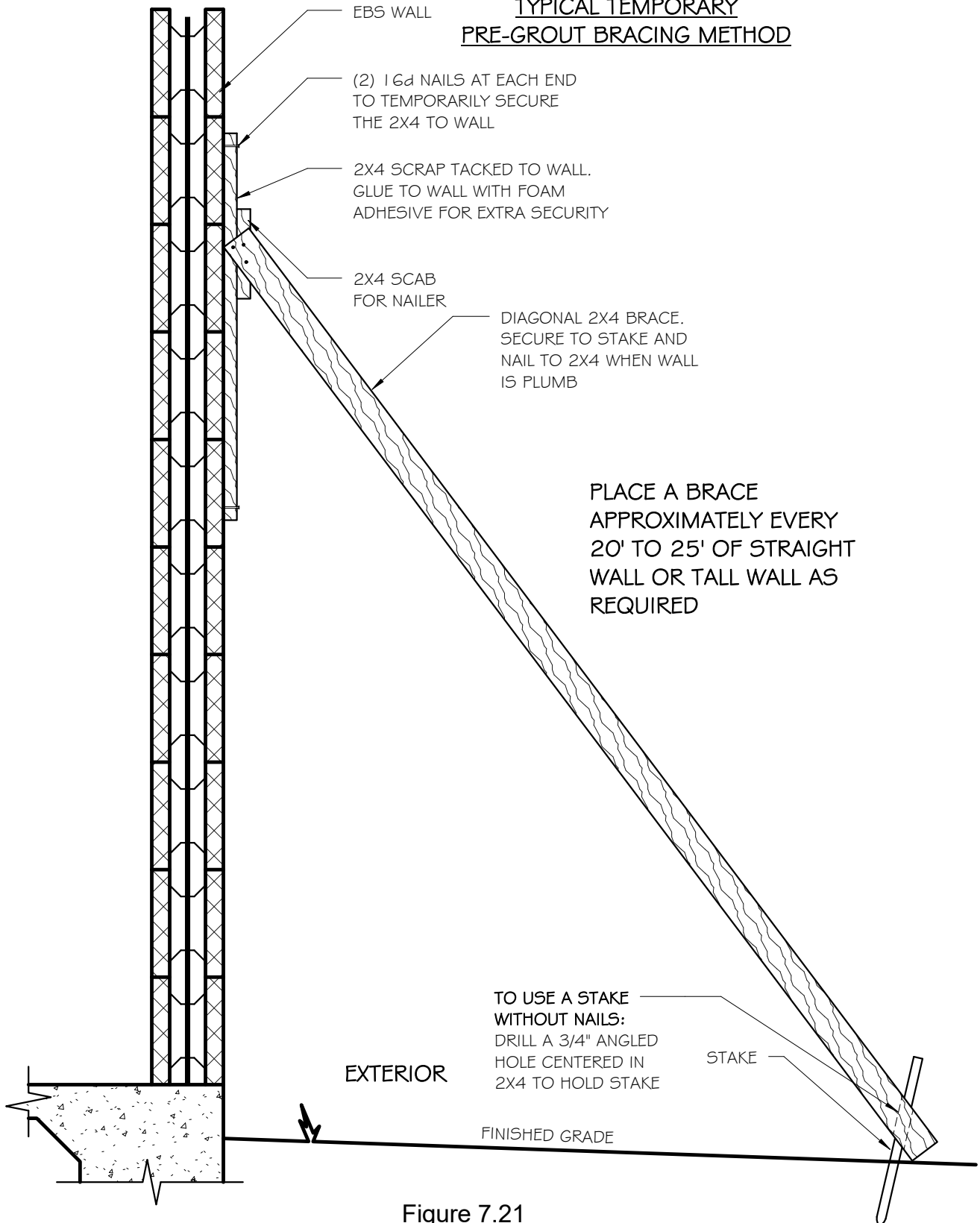

Figure 7.21

## WALL CONSTRUCTION

UPDATED 9/23/20

### Bracing the Walls (Cont.)

#### SIMPLE TEMPORARY PRE-GROUT BRACING METHOD I SECURING TO THE STAY-IN-PLACE PRESSURE TREATED WOOD DOOR OR WINDOW BUCKS

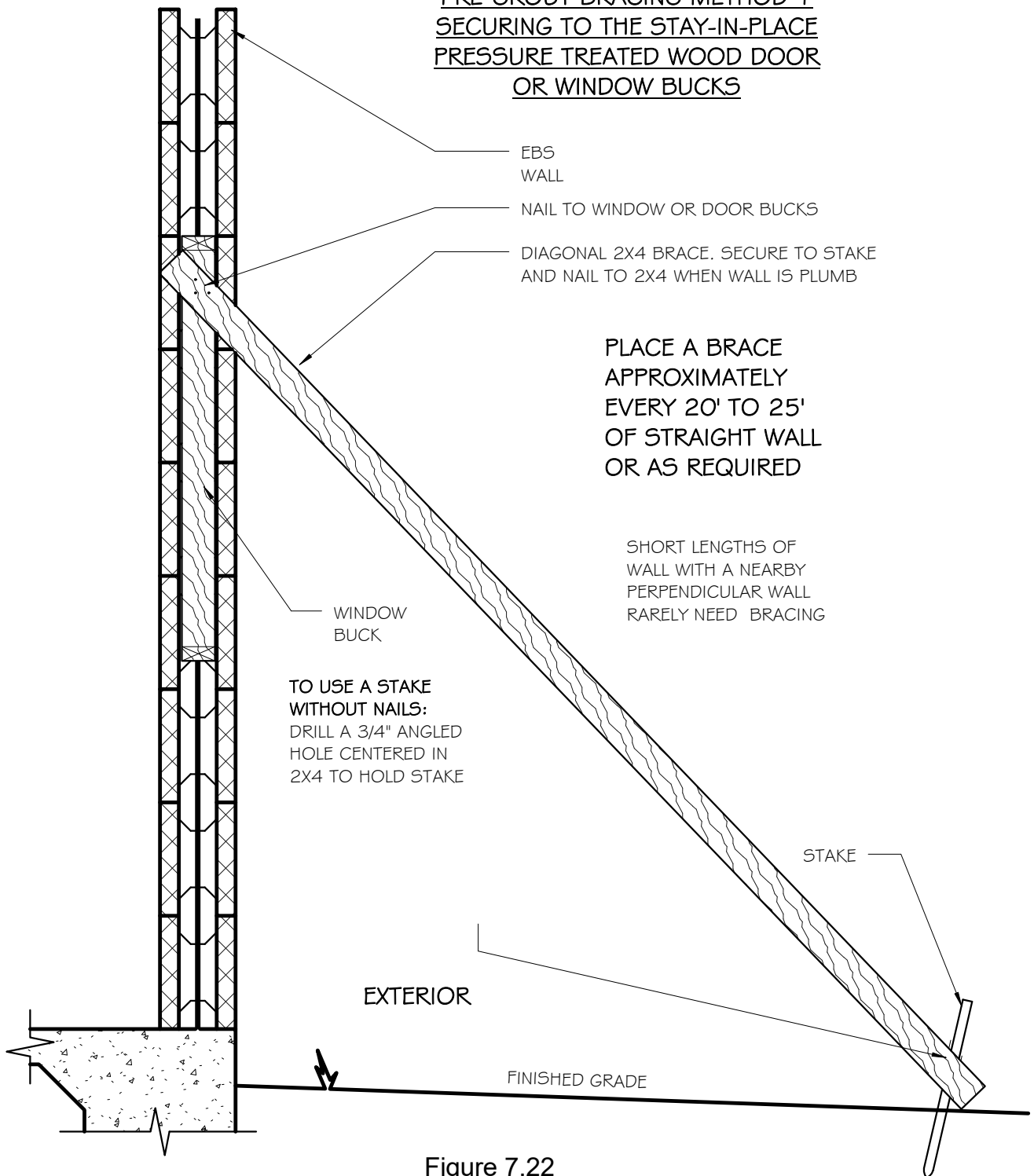

Figure 7.22

## SIMPLE TEMPORARY BRACING I

SCALE: 3/4" = 1'-0"

## WALL CONSTRUCTION

### Bracing the Walls (Cont.)

#### SIMPLE TEMPORARY PRE-GROUT BRACING METHOD 2

UPDATED  
9/23/20

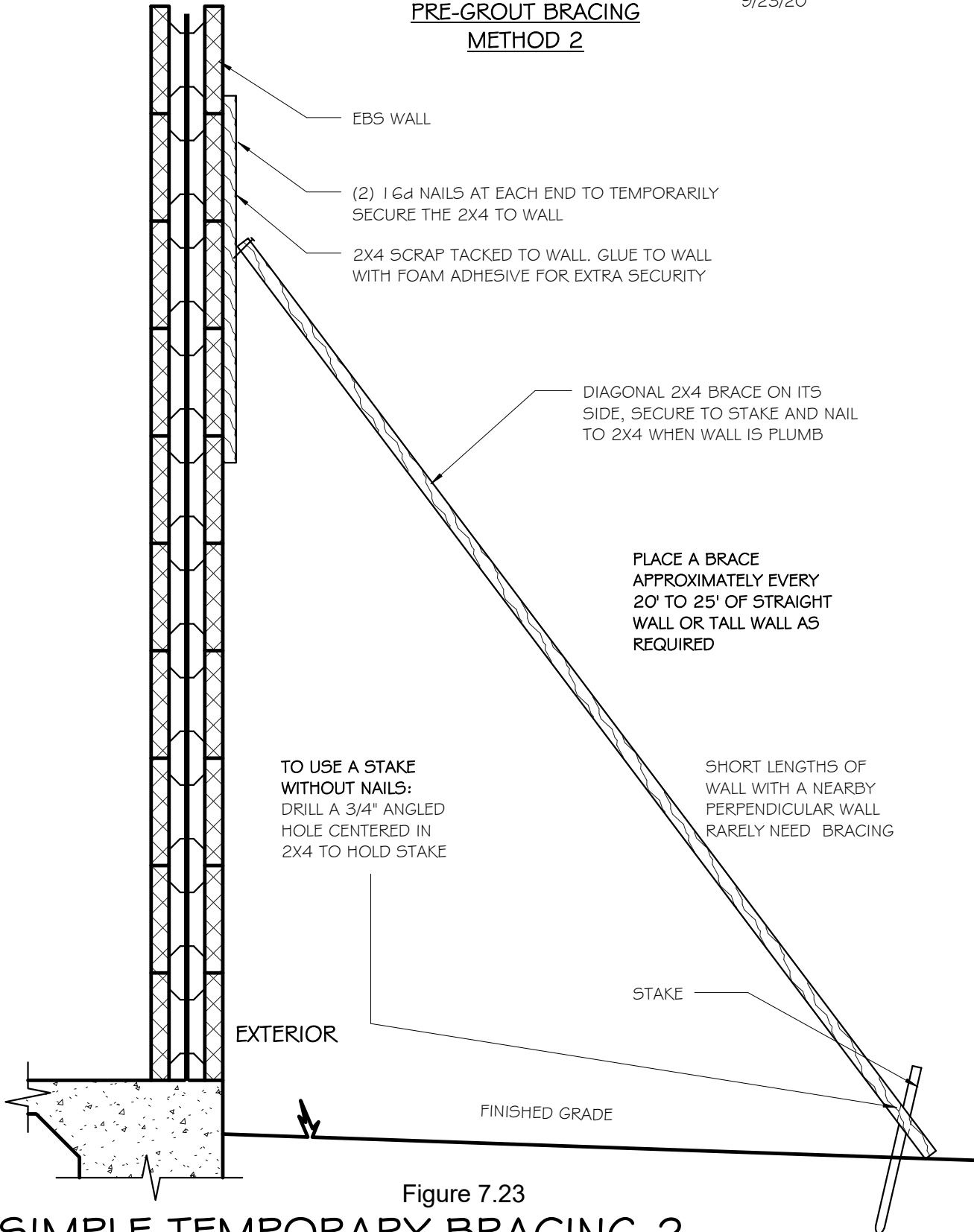

Figure 7.23

## SIMPLE TEMPORARY BRACING 2

SCALE: 3/4" = 1'-0"

## WALL CONSTRUCTION Bracing the Walls (Cont.)

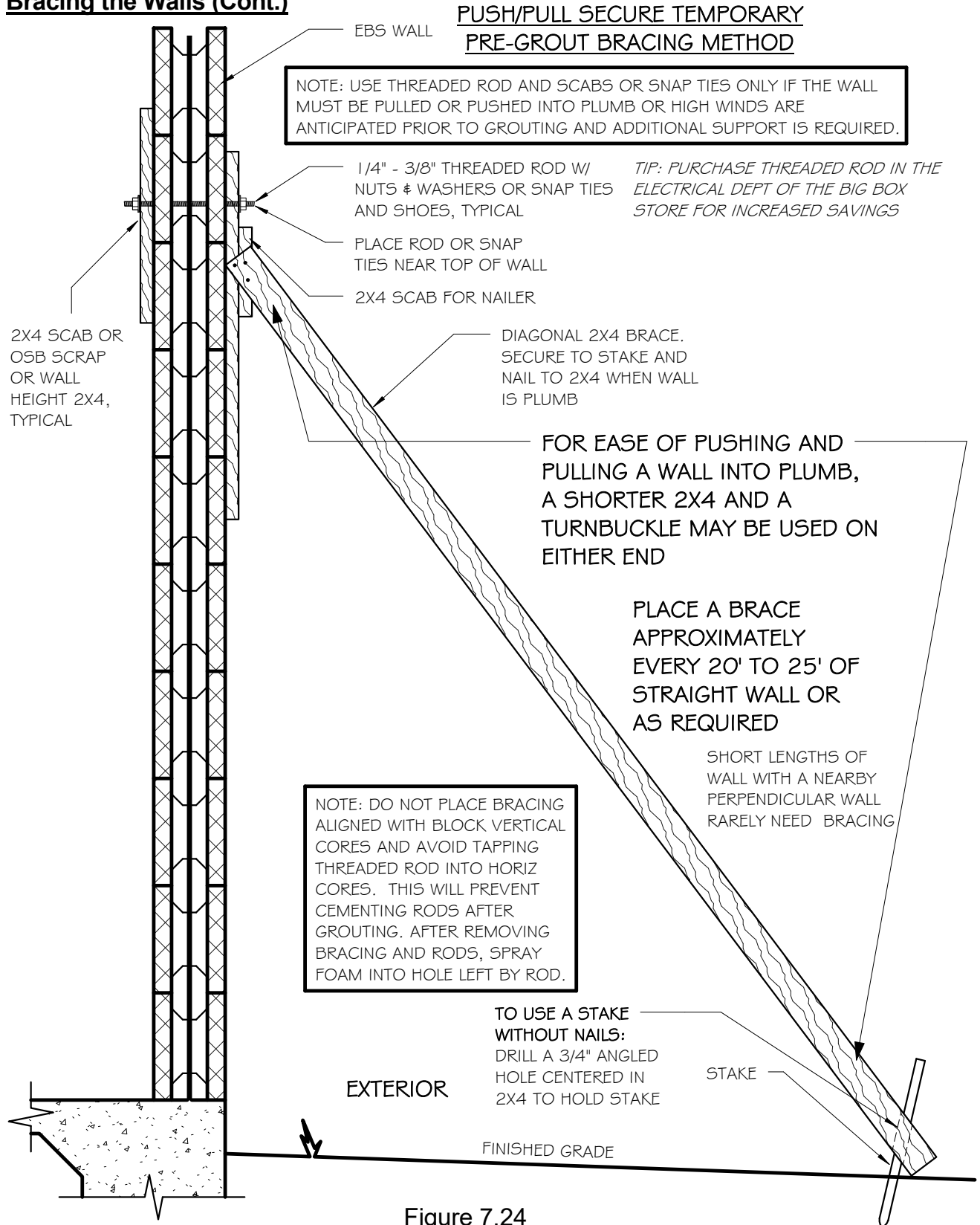

Figure 7.24

## EBS WALL- PUSH/PULL SECURE BRACING

SCALE: 3/4" = 1'-0"

## WALL CONSTRUCTION Simple Wall Strengthening Methods

THIS IS AN INEXPENSIVE AND LABOR SAVING METHOD TO ENHANCE STRUCTURAL STRENGTH OF AN ICCF WALL BY ADDING POURED CONCRETE COLUMNS WITHOUT COMPLEX ICCF BLOCK MODIFICATION

Added  
3/16/21

PLAN VIEW, 10 INCH ASYMMETRIC BLOCK, UNMODIFIED

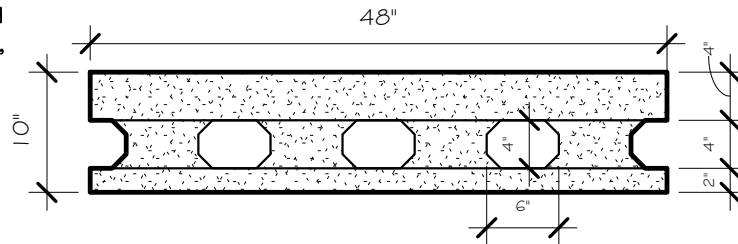

NOTE: PILASTER CAN BE CONSTRUCTED ON EITHER THE EXTERIOR OR INTERIOR OF THE WALL

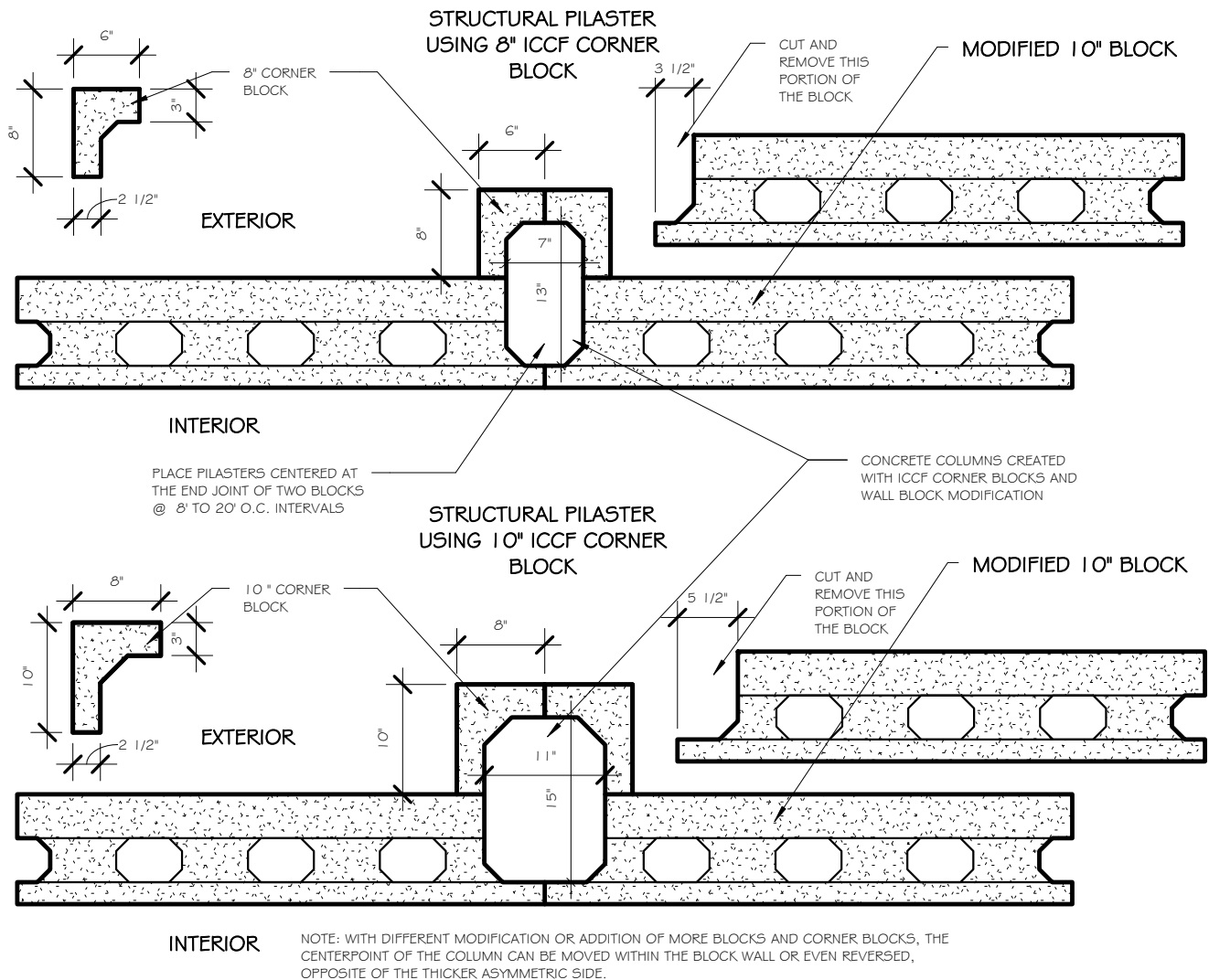

## STRUCTURAL PILASTER 10" ASYM ICCF BLK

SCALE: 3/4" = 1'-0"

## WALL CONSTRUCTION

### Simple Wall Strengthening Methods (Cont.)

THIS IS AN INEXPENSIVE AND LABOR SAVING METHOD TO ENHANCE STRUCTURAL STRENGTH OF AN ICCF WALL BY ADDING POURED CONCRETE COLUMNS WITHOUT COMPLEX ICCF BLOCK MODIFICATION

Added  
3/16/21

PLAN VIEW, 10 INCH  
6"X6" CORE BLOCK,  
UNMODIFIED

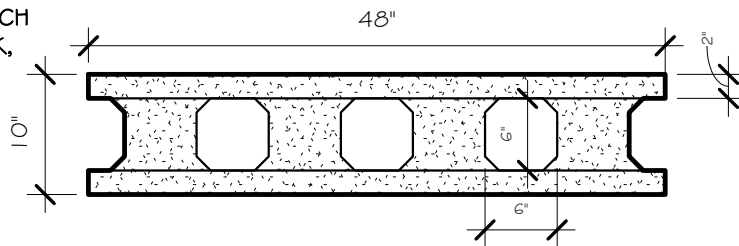

NOTE: PILASTER CAN BE CONSTRUCTED ON EITHER THE EXTERIOR OR INTERIOR OF THE WALL

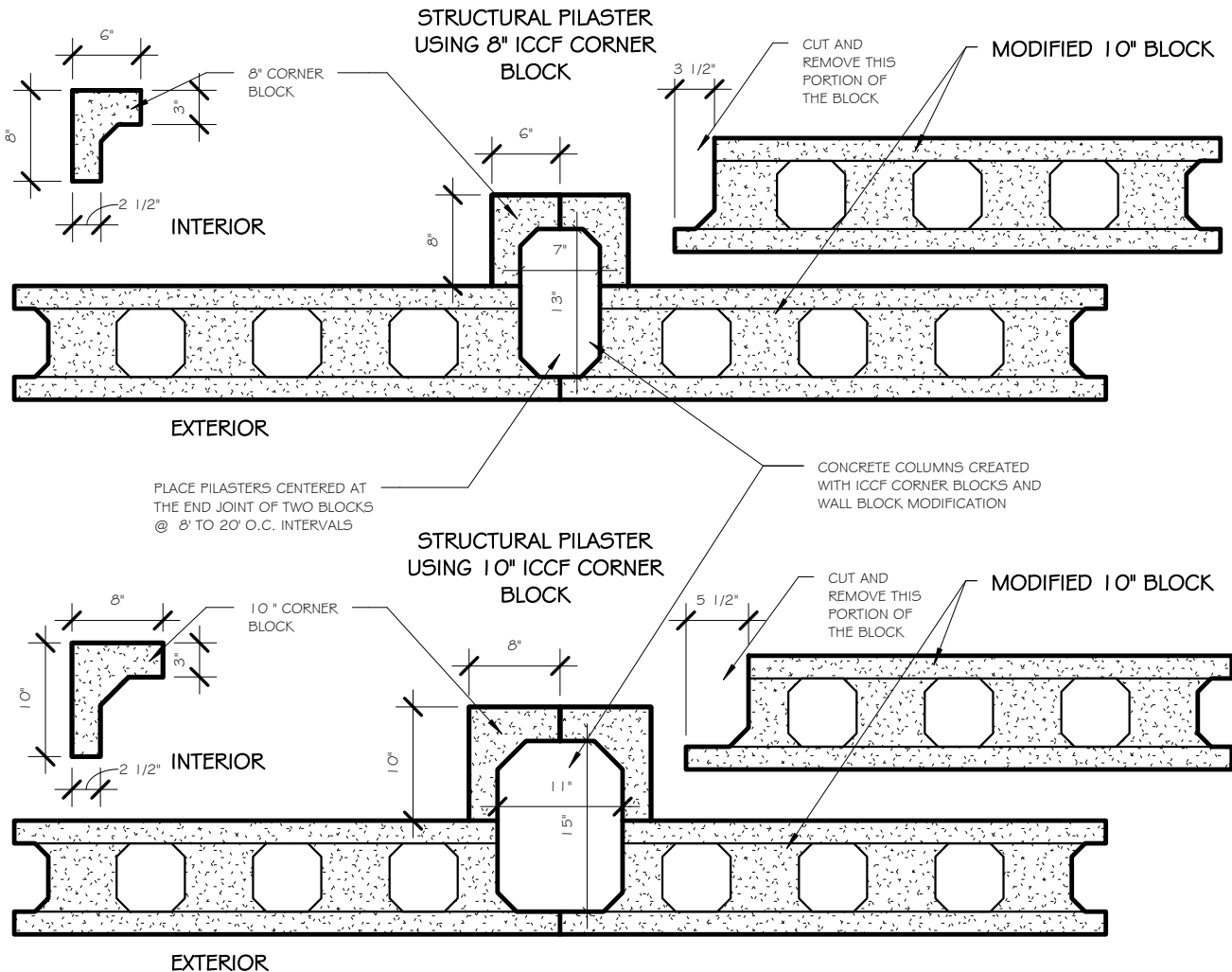

PLACE PILASTERS CENTERED AT THE END JOINT OF TWO BLOCKS @ 8' TO 20' O.C. INTERVALS

NOTE: WITH DIFFERENT MODIFICATION OR ADDITION OF MORE BLOCKS AND CORNER BLOCKS, THE CENTERPOINT OF THE COLUMN CAN BE MOVED WITHIN THE BLOCK WALL.

## STRUCTURAL PILASTER DESIGN 10" 6"X6" ICCF BLK

SCALE: 3/4" = 1'-0"

## WALL CONSTRUCTION

### Simple Wall Strengthening Methods (Cont.)

THIS IS AN INEXPENSIVE AND LABOR SAVING METHOD TO ENHANCE STRUCTURAL STRENGTH OF AN ICCF WALL BY ADDING A SHORT PERPENDICULAR WALL (A BUTTRESS) WITHOUT COMPLEX ICCF BLOCK MODIFICATION

NOTE: THE BUTTRESS WALL CAN BE CONSTRUCTED ON EITHER THE EXTERIOR OR INTERIOR OF THE WALL

PLAN VIEW, 10 INCH 6"x6" CORE BLOCK, UNMODIFIED

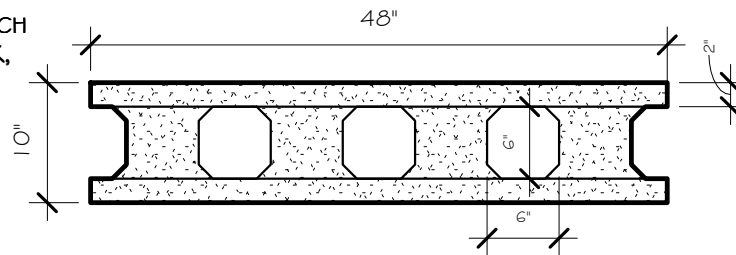

PERPENDICULAR WALL USING STANDING 10" 6"x6" CORE ICCF BLOCKS AND 10" ICCF CAP BLOCKS

STANDING BLOCK CAN BE PLACED ANYWHERE ALONG THE WALL. SECURE PERPENDICULAR WALL TO EXTERIOR WALL WITH 90 DEG ANGLED REBAR WITH 6" DIAMETER HOLES CUT FOR CONCRETE FLOW INTO HORIZONTAL CORES

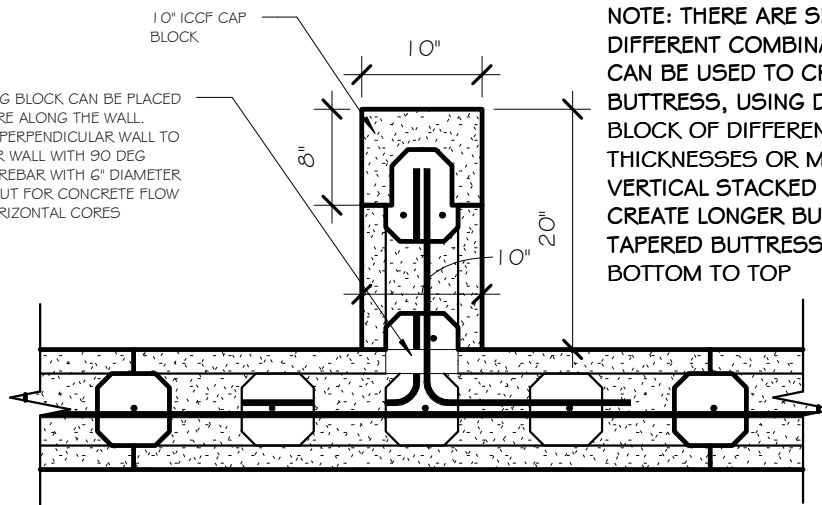

NOTE: THERE ARE SEVERAL DIFFERENT COMBINATIONS THAT CAN BE USED TO CREATE A BUTTRESS, USING DIFFERENT WALL BLOCK OF DIFFERENT THICKNESSES OR MORE THAN ONE VERTICAL STACKED BLOCK TO CREATE LONGER BUTTRESSES OR TAPERED BUTTRESS WALL FROM BOTTOM TO TOP

## STRUCTURAL PERPENDICULAR WALL (BUTTRESS)

SCALE: 3/4" = 1'-0"

## WALL CONSTRUCTION

### Simple Forming for Stand-Alone Concrete Columns

THIS IS AN INEXPENSIVE AND LABOR SAVING METHOD TO CREATE  
POURED CONCRETE COLUMNS WITHOUT COMPLEX FORMING

#### ICCF COLUMN FORMING

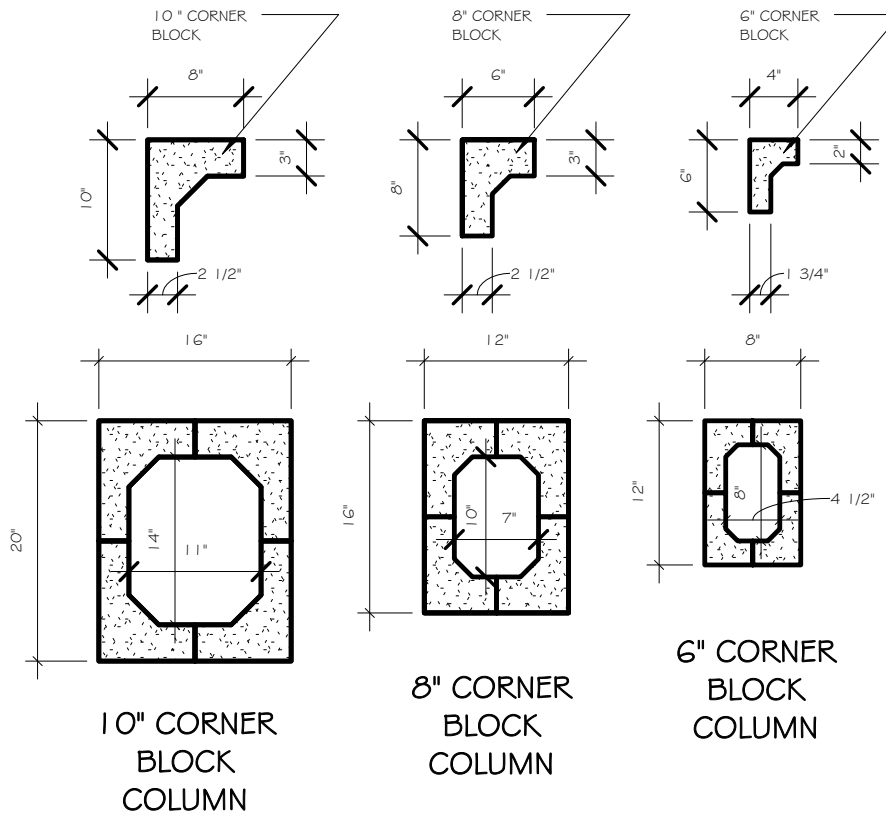

CORNER BLOCKS CAN BE RIPPED TO WIDTH TO  
CREATE SQUARE COLUMNS WITH CHAMFERS

Added  
3/16/21

## STAND-ALONE CONCRETE COLUMN FORMING

SCALE: 3/4" = 1'-0"

## WALL CONSTRUCTION

### Free Standing Fence Wall - Zero Property Line Detail

When using ICCF block for a free standing wall, and placing the wall as a property line perimeter wall, the owner of your next door property may not want a wide spread footing for that wall that would encroach on his or her property. In that case, a deep post footing at a sufficient interval to resist tipover, may be used right up to the property line.

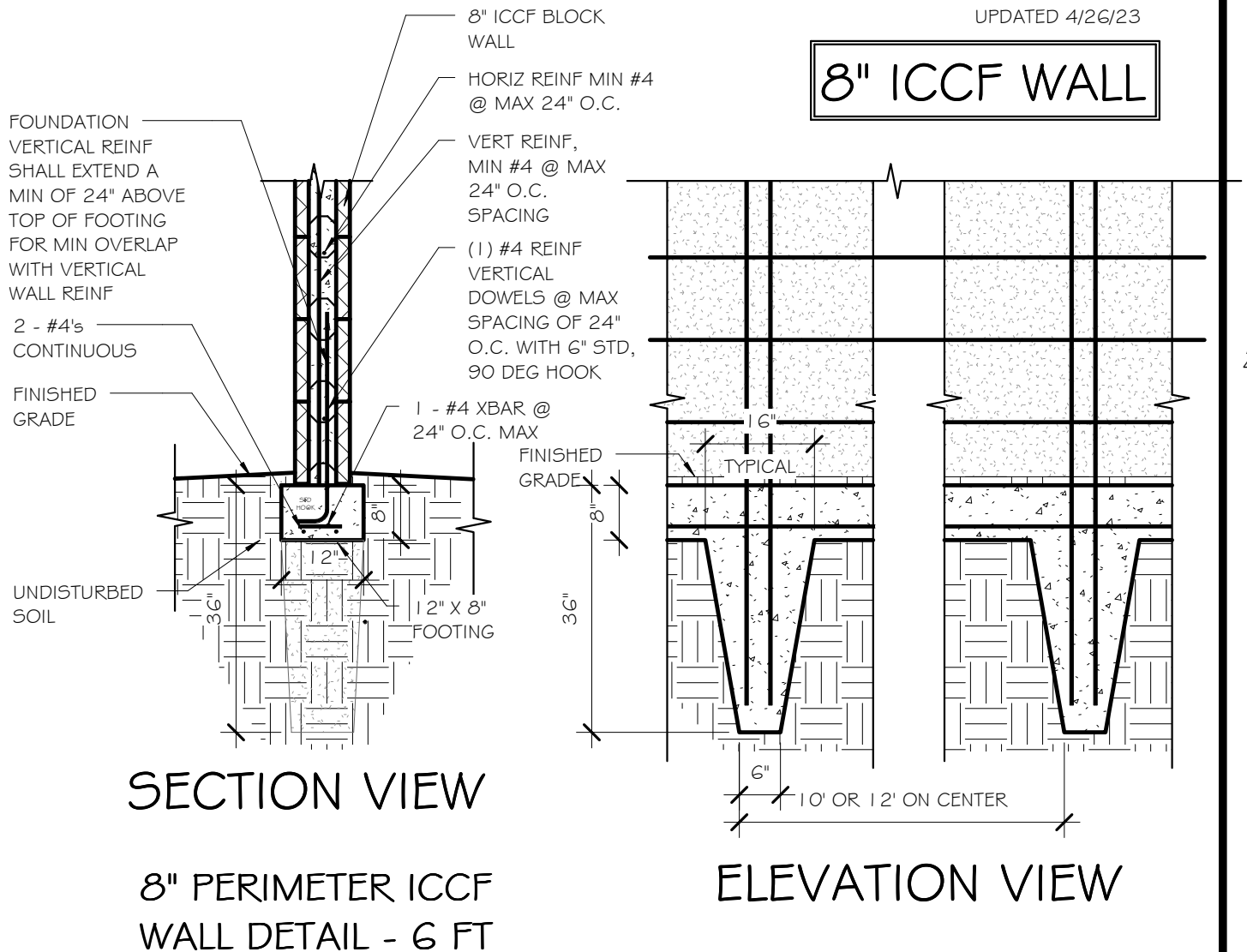

Added  
4/26/23

## FDN FTG FOR 6' 8" BLOCK PERIMETER WALL

SCALE: 1/2" = 1'-0"

# Eco Building Systems Corp.™

## WALL CONSTRUCTION

### Free Standing 6' Combo 10' & 6" Blk Fence Wall - Zero Property Line Detail

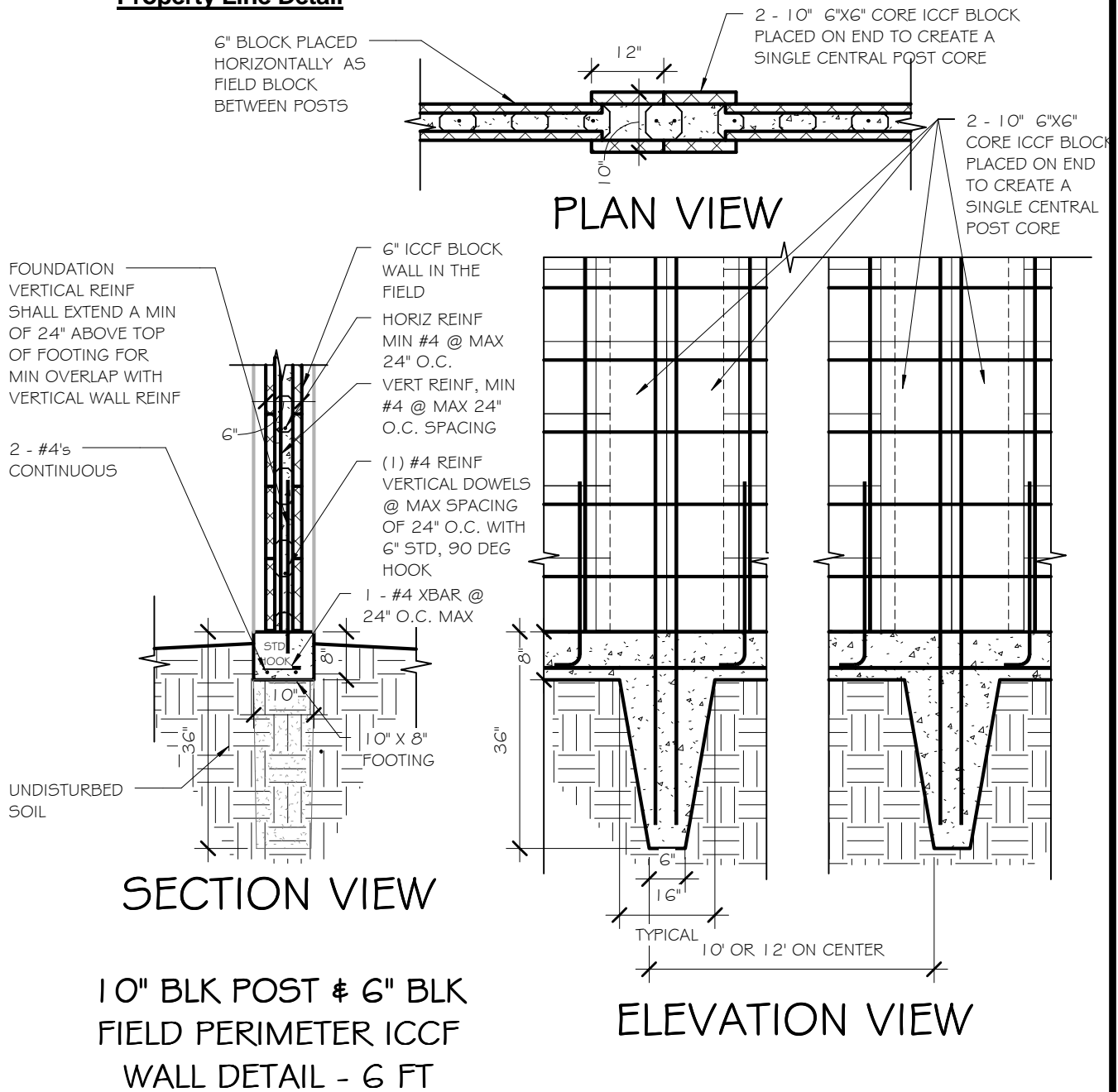

Added  
4/26/23

## FDN FOR 6' COMBO 10" & 6" BLK PERIMETER WALL

SCALE: 1/2" = 1'-0"

## GROUTING

### Grouting

Grouting is filling the internal cores of an erected wall of ICCF block with concrete. Concrete used in this fashion is commonly called "grout". In over two decades of grouting experience, we have learned the lessons of what works well and what does not and we will share those with you in this section. We use grouting techniques that make grouting a simple task. The key to a successful grout is good preparation. Definitely use the checklist included in this section. It can be a great reminder of things to do before that concrete truck comes up the drive. With proper building techniques accompanied with good preparation, grouting means the erection of your walls is nearly complete and ready to finish.

Following the Pre-Grouting Checklist provided on the next pages will minimize some of the more common mistakes committed on "Grout Day" and EBS highly recommends its use. Please review the checklist and prepare for grouting. Add any additional steps that you think may be required for your unique design or jobsite.

The following is a suggested method for grouting a typical house design:

Before "Grout Day", the decision to grout from the top of the erected wall or at an intermediate level or "lifts" must be made. Typically, the height of the wall may determine your best grouting method. In a one day pour, to reduce the height that the pumped concrete must fall, walls, 10' tall or over, should be grouted in subsequent levels or "lifts" of 5' or less in height to prevent dropping heavy wet concrete 10' or more. Using a "boom" concrete pump truck is not recommended but can be used if that is the only equipment available. Special care must be taken when pumping concrete from a boom pump. The force created by falling concrete from excessive heights can put undue stress on the block forms and could cause unwanted "blowouts" and additionally weaken the concrete by separating the concrete aggregate from the mix as it impacts rebar as it falls. We recommend using a trailer mounted concrete line pump.



Concrete truck and line pump



Line pump



1 1/2" diameter stinger  
length of pump hose



1 1/2" diameter stinger  
length of pump hose



Concrete truck and line pump

## GROUTING

### Grouting (Cont.)

**Builder's Tip:** We are aware that the available concrete pumping equipment varies significantly from one region of the country to the next. The use of a concrete line pump may not be common in your area, but they are used throughout North America so you are likely to find one. We have found that a line pump solves most of the grouting problems created by a boom truck. First, a line pump usually costs less than half what a boom truck costs to use. Second, the line pump allows you to pump in "lifts" and provides flexibility to your grouting methods that boom trucks do not. Third, a line pump hose is smaller, reducing the chance of pumping too much concrete, too fast. And fourth, you can have near instant control of concrete flow for a quick "shot" at a time that most boom pumps cannot provide.

**Builder's Tip:** A trailer mounted concrete line pump setup will usually come with 150' of 2" diameter hose. You will be able to grout with a 2" hose, but ask the line pumper to bring a 1 1/2" diameter stepdown hose (a "stinger") to attach to the 2" hose. There is almost double the volume of concrete and hence, double the weight you will have to control on your shoulder using a 2" hose compared to a 1 1/2" hose.

Grouting with a Line Pump:

With a line pump, grout a 10 - 12' or greater wall in levels or "lifts", cut 4" - 5" holes on the interior side of the walls, aligned with a vertical core at every 3' or 4' on center in your wall at 5' high. Place the cut plug you remove from each cut hole near the hole and secure to wall with 16d nails for quick retrieval. The plug will be reinstalled and glued with ample foam adhesive immediately after filling the cores with grout to that hole level to ensure curing time before grouting from the top of the wall or the next lift. 16d nails temporarily toe nailed (can be pushed in by hand) into the plugs can give additional mechanical hold to the plug until the foam adhesive hardens (approximately 15-20 minutes).

### Pre-Grout Photos

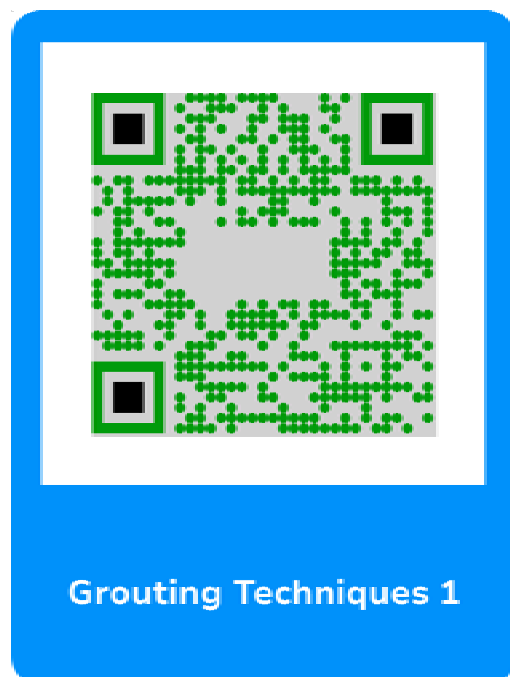

## GROUTING

### Pre-Grout Photos



This photo shows the block wall prior to grouting and prior to scraping the tack glue from the face of the wall. Notice the "fish plating" where we have identified areas of concern. The minimal exterior bracing is also a precaution. The top corner of the wall is blocking for a beam seat.



## GROUTING

### Grouting Photos



## GROUTING

### Grouting Photos (Cont.)



## Scaffolding

**Builder's Tip:** We recommend that the scaffolding that you use is professional size scaffolding that you can purchase or rent. Preferably 3 tiers, 5'x5' or taller, with several deck planks to build platforms, four locking swivel caster wheels, and guard rails for fall protection.

The narrow unstable mail order scaffolding (typically yellow) is NOT recommended. These are for small jobs, like interior painting, not jobsite construction. The compromise on job safety that the little savings on cost that you get with unstable scaffolding, does not warrant the risk of injury.

## GROUTING

### Grouting (Cont.)

**Builder's Tip:** In our construction experience pumping concrete in ICCF walls for decades, we **HIGHLY** recommend pumping your concrete in "lifts" in a circle around the house from the inside. Fill window sills first and a course or two of block cores on each side of door openings from the cut holes on the interior side of the walls of the first lift (5') on each side of the openings in your first circle around the perimeter (fill the window sills from the holes on each side of the windows until the grout rises to the top of the sill and stop). Then fill to 5' of wall height in another circle around the inside perimeter of the building, then from rolling scaffolding, fill 5' of wall height on each subsequent circle until filling from the top of your wall. The extra time and labor cutting intermediate holes in your walls to pump in 5' lifts is incredibly cheap insurance against having a "blowout" in your wall. In addition, it is inherently safer to pump in lifts rather than initially from the top of a wall. As you pump each lift, the concrete is beginning set, providing additional stability as you prepare to pour the next lift. These "lifts" are typically completed one after another on the same day until one floor of wall has been grouted.

Added  
7/10/21

The reason this tip is in RED is to emphasize the need to exercise good and proven technique when grouting. A "blowout" or even more than one will definitely ruin your day. "Blowouts" were a common and unwelcome experience years ago from other ICF and ICCF forms. Some of them attributable to weaknesses in the form but most from poor grouting technique. At EBS, when we grout, "blowouts" are a thing of the past. EBS ICCF forms are monolithic and strong, but you must identify and "shore up" weak areas (areas where you have cut the block and created "core wings", greater than 3" or removed webs for plumbing) and grout smartly.

Added  
7/10/21

Expanding on the previous **Builder's Tip**, let's start the grouting sequence from the beginning, assuming that you have completed the pre-grout checklist and are ready:

First choose the grout start point and the direction you will proceed in a circle around the house on the inside of the house (clockwise or counterclockwise). Grout all openings (windows and doors) first. That will be the first level or lift you grout. For a clean sill pour, first grout (pump from hose) into the holes that are 5' high directly adjacent to the window opening, left and right side. Stop pumping when the level of grout is level with the sill. [Note: If you are using an open sill buck (no bottom board), be prepared with a 2x blocking to stop overflow of concrete from sill if you pump too much with a high slump. Hold the blocking or secure in place until the concrete sets enough to keep from pouring out of the sill.] Then proceed to grouting the next openings. In the same circle, fill on each side of door openings the same way as window sills but only place enough concrete to fill a course or two, then proceed to the next opening until the circle is complete. A worker following behind you that will be plugging and gluing the holes you pumped into at the 5' intermediate lift, can also trowel the concrete smooth in the sill opening you just filled.

**Builder's Tip:** Tapping gently on the window and door bucks with a rubber mallet just after grouting the openings, can help the concrete to settle and fill solidly behind the bucks.

## Grouting (Cont.)

**Builder's Tip:** Most concrete pumpers initially fill their hoses with water before pumping concrete from the hopper to ease the flow of concrete at the start. To prevent pumping just water into your walls, keep the nozzle pointed out the window or in a bucket until concrete is pumping from the hose.

After filling the wall cores on each side of the openings and ensuring the window sills are grouted to level in your chosen direction, begin to grout from the cut holes at your 5' intermediate level in the same direction.

Have a worker trowel the sills and glue the hole plugs as you fill. (Note: The time it takes to pump concrete in a complete circle at each level should be long enough for the pumped concrete to set enough and the spray foam adhesive used to secure the hole plugs to harden enough to prevent popping a plug and pouring out a lower level.) The last level (assuming a 10' wall) to grout is from the top of the wall. Two to three tiers of scaffolding on wheels and several platform decks will definitely make the job go smoother and from our perspective, absolutely necessary for a safe and efficient grouting. As you pump concrete from the top of the wall, you can use the vertical rebar to help "hand vibrate" or "rod" the concrete to ensure better flow of the grout if necessary.

**Builder's Tip:** You should continually monitor the flow and consistency of the concrete you are pumping. If you think you need to "hand vibrate" the concrete to aid the flow, then you should probably stop pumping and have the concrete truck driver add 5 to 10 gallons of water to the mix before resuming grout pumping to improve concrete flow.

Once you have grouted to the top of the wall, have a worker go behind you and trowel the grout smooth with the top of wall and have them place the code required anchor bolts in and aligned with the vertical cores at the proper spacing. Ensure the bolt threads exposed above the concrete surface allow for the top plate thickness (1 1/2") and nut and washer thickness (1 1/4").

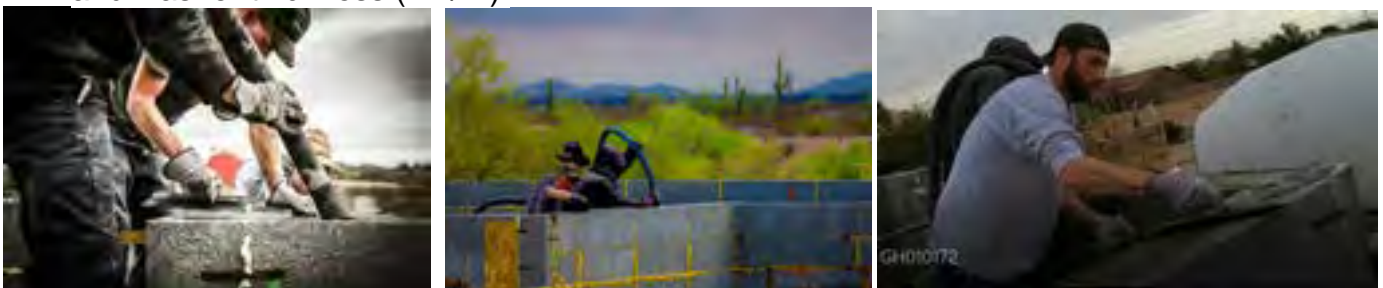

**Builder's Tip:** Before grouting, place a visible spray paint mark on the face of the wall at the top, for proper placement of anchor bolts. This technique can save costly omission and placement mistakes. An anchor bolt must be placed within 12" of the end of each length of top plate board. Consider whether you will have butt or miter joints for your top plate boards at each of the corners and the length of the boards you will use and place your paint marks accordingly.

When the grouting is complete and if there is concrete remaining, it can be used for other preplanned uses such as doorstep pads or other useful projects (as described in the Pre-Grout Checklist) so no concrete is wasted.

## Grouting (Cont.)

### Post Grouting

As soon as possible after grouting, scrape or sweep the concrete that may have spilled onto your finished concrete floors or patios that were not covered. If the spots of spilled concrete are allowed to harden they could permanently mar your floor finish and be very difficult to remove. This is the time to break loose or remove any spilled concrete from anything, inside or outside the walls if you don't want the spilled concrete to become a permanent finish on your floors, tools, doorsteps, construction materials, etc.

Support blocking or bracing should remain in place for as long as possible to allow the grout concrete to harden to its maximum strength.

### Alternative Grouting - With Safety in Mind -

#### **HIGHLY RECOMMENDED FOR FIRST TIMERS!!!!!!!!!!!!!!**

The grouting technique previously described is for grouting an entire wall in one "grout" day. We typically grout our walls this way but there are occasions where we have stopped building at the 6' or 7' level, placed vertical steel with the appropriate rebar lap splice for continuing the wall to the finished wall height later and then pour concrete to a 5' height. In the following days, we build to the top of the wall and grout again. The occasions that drive our decision to build and grout to an intermediate level and not to the top are almost always driven by "safety". If the wall is 12', 14', or 20' plus, it makes sense not to try and pump heavy wet concrete to such heights in one day pours unless you have years of grouting experience. An inexperienced crew or not having an abundance of extra hands on grout day would be a good reason to limit the height of your pour. Weather can drive that decision too. If the walls are tall, they are big targets for thunderstorms, microbursts, "monsoons", high winds, etc. They can destroy a week's work in a heartbeat if extra bracing is not used. Having a solid wall to build on early in the wall construction adds a greater safety margin to all the remaining construction. Of course, one of the downsides is that you will have to pay for the concrete pumper more than once. There is no harm and no foul grouting to intermediate levels if you believe it makes good sense to you. The skill you develop on the first concrete pour, will serve you well on the next, more difficult concrete pour. Use good judgement when planning your grout day.

Changed  
1/02/23

**Specific Note to Grouting the Larger Cores of the 10-inch 6" X 6" Core The Perfect Block ICCF:** For those builders building with the 10-inch 6"X6" core ICCF, as the manufacturer, Eco Building Systems Corp (EBS), recommends using special care as described in the previous paragraph and the grouting methods detailed on the previous four pages to ensure a safe and successful concrete grout pour. Because the larger (larger than the 4"X6" cores of TPB's 8" and 10" Asymmetric ICCF) internal cores of the 10-inch 6"X6" Core ICCF will consume 35 to 40% more concrete during the grout pour, the increased internal pressure exerted by the additional heavy,

## **Grouting (Cont.)**

### **Alternative Grouting - With Safety in Mind (Cont.)**

wet concrete may significantly increase the potential for a blowout. For this reason, EBS recommends pumping concrete slowly and stopping at intermediate levels of 4', 5', or 6'. Care should be taken to not pump concrete too fast, and to not drop concrete from heights greater than 4' or 5' per poured concrete lift.

**Builder's Tip:** When building an ICCF wall to an intermediate level or "stage" and pouring concrete to that level in the manner described in the previous paragraphs, you will create the need for a "lap joint". You must have the proper overlap (lap splice) of vertical steel between the next level of wall that you build. Ensure the vertical steel that is placed in the first level, extends the proper length of lap splice beyond the top of the first intermediate level to be lapped with the vertical steel from the next level when it is built.

## GROUTING

### Pre-Grout Checklist

When your ICCF walls are erected to your design height and you are ready to grout the walls, use this suggested pre-grout checklist to ensure you have not overlooked something that can cause problems or delays.

- 1. Check wall design height against your plans (be sure to account for top plate thickness). Check all other height critical items such as top plate height changes and beam seat heights, sill heights, lintel heights, etc.
- 2. Check the top of each ICCF wall for level with a transit, water level, or laser level or from a "control line" if you used one. Trim the top of wall as necessary.
- 3. Check wall bracing for strength and security. Bracing can be used to bring a wall into plumb.
- 4. Inspect all openings for secure bucks and bracing and check squareness. Reinforce as necessary.
- 5. Ensure all window opening sill bucks (if used) have "sight" holes cut in them to see level of grout in the sill.
- 6. Review plans for all service penetrations (water, sewer, electrical, and gas) and check locations. Reinforce all modified areas as necessary.
- 7. Review plans for all design beam pockets and check locations and beam seat heights. Reinforce all pockets as necessary.
- 8. Search for any suspected weakness in wall construction (i.e. beam pockets, plumbing and electrical "rough-in" access cuts, openings with unsupported flanges, etc.) and scab or "fishplate" with plywood and threaded rod and/or brace as necessary.
- 9. Check all ledgers or ledger blocking to ensure they are installed at correct locations, level, and firmly secured and supported.
- 10. Check that your spray paint marks at the top of each wall for proper placement for top plate anchor bolts are clearly visible for quick bolt placement.
- 11. Check for proper vertical rebar placement and spacing. We recommended that you place a paint mark at the core location on the very first course of block where the vertical rebar comes out of the foundation. Ensure there is a floor height length of rebar in a vertical core placed from the top of the wall where there is a paint mark for foundation rebar.

## GROUTING

### Pre-Grout Checklist (Cont.)

- 12. Check top bond beam horizontal reinforcement steel and corner bars at the building corners for proper placement and overlap.
- 13. Stage necessary materials and tools (plywood, 2x4's, stakes, circular saw, hammer, and nails, spray foam gun and extra adhesive foam cans, etc.) nearby to repair possible blowouts, if necessary.
- 14. Check rolling scaffolding for security and stability and ease of movement. Ensure there are no obstacles on the slab that would interfere with the scaffolding.
- 15. Locate, count, and stage top plate anchor bolts for easy retrieval for placement when grouting is finished. Paint a placement mark on the top block course for quick and proper anchor bolt installation.
- 16. If the building corner end elements have been left off until just prior to grouting, ensure all horizontal rebar steel and corner rebar are all in place before completing wall corner construction.
- 17. Inspect all corner end elements for proper construction and ensure they are securely glued, stapled, and/or braced for concrete pour.
- 18. Ensure your job site is accessible to concrete trucks, pump trucks, and/or trailer concrete pumps.
- 19. Determine beforehand, a wash out location for your concrete trucks and pumps.
- 20. Prepare beforehand, framing for useful concrete pads or other useful things to utilize any concrete left over after wall grouting.
- 21. Calculate required concrete quantity with 5-10% overage for contingencies. One yard of concrete over is much better than being one half yard short.
- 22. When you are certain that you are ready to grout, schedule your concrete truck(s) with proper quantity, type, and slump of concrete and proper arrival timing of trucks (45 - 60 minutes apart).

#### **Recommended Grout Order for Concrete Batch Plant:**

**Order a "grout mix", "flowable", at 3000 psi, aggregate less than 3/8" (pea gravel preferred), and an 8" to 10" slump (the higher the slump, the more fluid the grout).**

If your local batch plant has difficulty providing a grout mix, here's the recipe for a [3000 psi grout mix](#) from Arizona Materials in Phoenix that you can provide them:

560 lbs of cement, 130 lbs of fly ash, 2190 lbs of sand, 710 lbs of 3/8" aggregate, 350 lbs of water for 8" slump. Az Materials also adds 10 ounces of 69% water reducer and plasticizer.

Added  
6/29/21

## **GROUTING**

### **Pre-Grout Checklist (Cont.)**

- 23. When you contract for the concrete pump company, have them confirm that the concrete pump truck they are sending will be carrying a 1 1/2" hose to connect to the pump hose. Otherwise, you will have to be "Superman" to carry and control a hose of greater diameter filled with surging concrete.
- 24. Schedule your pump truck to arrive approximately 30 minutes prior to the concrete truck so there is ample time for the pump to be set up and hoses to be unrolled and placed before the concrete arrives. Establish with your concrete pump guy prior to concrete pumping, clearly understood voice and hand signals for starting and stopping the concrete flow.
- 25. Coordinate with the pump guy to have his pump equipment pump at its slowest rate for adequate flow of concrete. Concrete slump and length of hose will affect this pump setting, but pumping at a slow rate is safer and gives you more control at the hose nozzle.
- 26. Ensure the concrete company has detailed directions to your jobsite and phone numbers to reach you. For remote building sites, be prepared to meet the driver at nearby known cross streets and guide him to your site.
- 27. Clean and remove unnecessary materials and obstacles around the exterior. Cover and protect anything you don't want spotted by concrete during grouting.
- 28. Stage a reciprocating saw (without the blade) and a wall height 2x4 close by for wall vibration if necessary.
- 29. Ensure you have enough laborers ready and available for grout day and assign each person with their tasks and responsibilities during grouting.

## **GROUTING**

### **Pre-Grout Checklist (Cont.)**

Suggested minimum number of workers to have for "Grout Day" and their duties:

1. One person to hold the hose and direct the flow of concrete.
2. One person to follow close by and help control the hose
3. One person to move scaffolding, trowel sills, place anchor bolts, and man a bucket for concrete overflow from the hose.
4. One person to provide relief and swap duties with the above when needed and to be on hand in the unfortunate event of having a "blowout". This person will also plug and foam wall holes, clean spills, clear a path and move scaffolding, move concrete hose, and do everything else needed in a hurry.
5. The one extra person you are paying is the concrete pump guy. He will turn the concrete flow on and off at your command and help moving the hose for the pumping crew.

EBS Note: In our experience, good construction technique (pumping concrete in lifts), attention to detail when searching for weak areas, "fish plating" those weak areas with OSB plywood and threaded rod, and lots and lots of foam adhesive (cheap insurance) will reduce the likelihood of having a blowout" to near zero.

### **Look on YouTube**

For more techniques, tips and information on grouting and building with The Perfect Block<sup>TM</sup> wall systems. Please visit our You Tube channel:

"The Perfect Block <sup>TM</sup> Composite ICF/ICCF Block"

## ROOF CONSTRUCTION - POST GROUT

### Roof Connection Method for Severe Weather

In coastal and tornado regions around the country where roof damage is more likely to occur, it is prudent to use stronger anchors to secure trusses that are more resistant to uplift to protect your roof. Combine these anchors, described below, with fully gluing with construction adhesive, your roof sheathing as well as screwing the sheathing with screws, instead of nails will add tremendous strength to your roof and trusses.

#### Truss to Wall Connection

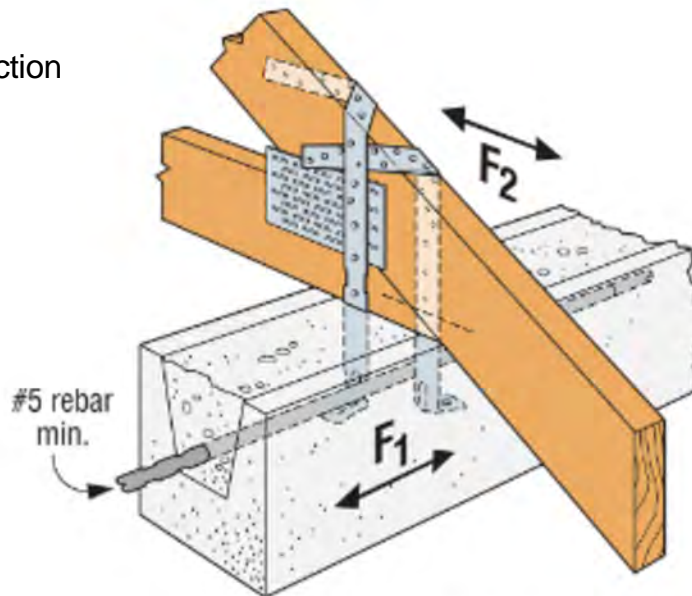

Typical Installation with Two METAs

The following YouTube video from Sharpe Roofing University, sharperoof.com, 727-375-7055, illustrates a much superior method of attachment of roof trusses to concrete walls over hurricane ties such as Simpson Strong-Tie H2.5's, H1's, H3's, etc. The YouTube video depicts installed double META20's or larger, truss anchors (straps with a hook embedded in grouted concrete in the wall) with the straps wrapped over the top chord of the truss and secured.

**Builder's Tip:** We at EBS will always isolate a non-pressure treated wood structure from being in direct contact with concrete to prevent moisture migration into the wood. The truss in the video below is in direct contact with the wall concrete. We do not recommend this. Using the TSS moisture barrier along with the META anchors (shown on pg 9.0a) is recommended or placing sill gasket material or 30 # felt between the truss and the concrete wall is a necessary precaution to avoid future moisture problems with the wood trusses.

The truss anchors must be placed when the concrete is wet, so the precise location of the truss on the wall must be known and marked, prior to grouting walls.

[youtube.com/watch?v=2mnzyP1fWCA&t=12s](https://www.youtube.com/watch?v=2mnzyP1fWCA&t=12s)

## ROOF CONSTRUCTION - POST GROUT

### Roof Connection Method for Severe Weather (Cont.)

Added  
6/28/24

Model No.	H (in.)	1-Ply Southern Pine (SP) Rafter/Truss				2- or 3-Ply Southern Pine (SP) Rafter/Truss				
		Fasteners (in.)	Uplift (160)	F <sub>1</sub> (160)	F <sub>2</sub> (160)	Fasteners (in.)	Uplift (160)		F <sub>1</sub> (160)	F <sub>2</sub> (160)
			GFCMU/Concrete				GFCMU	Concrete		
<b>Single Anchor</b>										
META12	8	(7) 0.148 x 1½	1,420	340	770	(6) 0.162 x 3½	1,450	1,450	340	770
META16	12	(8) 0.148 x 1½	1,450	340	770	(6) 0.162 x 3½	1,450	1,450	340	770
META18	14									
META20	16									
META24	20									
META40	36									
<b>Double Anchor</b>										
META12	8	(10) 0.148 x 1½	1,875	1,000	900	(14) 0.162 x 3½	1,795	2,435	1,285	1,080
META16	12	(10) 0.148 x 1½	1,875	1,000	900	(14) 0.162 x 3½	1,795	2,435	1,285	1,080
META18	14									
META20	16									
META24	20									
META40	36									

DETAL 20+ Double Truss anchors YouTube video from @missfitz1956

[youtube.com/shorts/NccA0Tu5UQ8](https://www.youtube.com/shorts/NccA0Tu5UQ8)

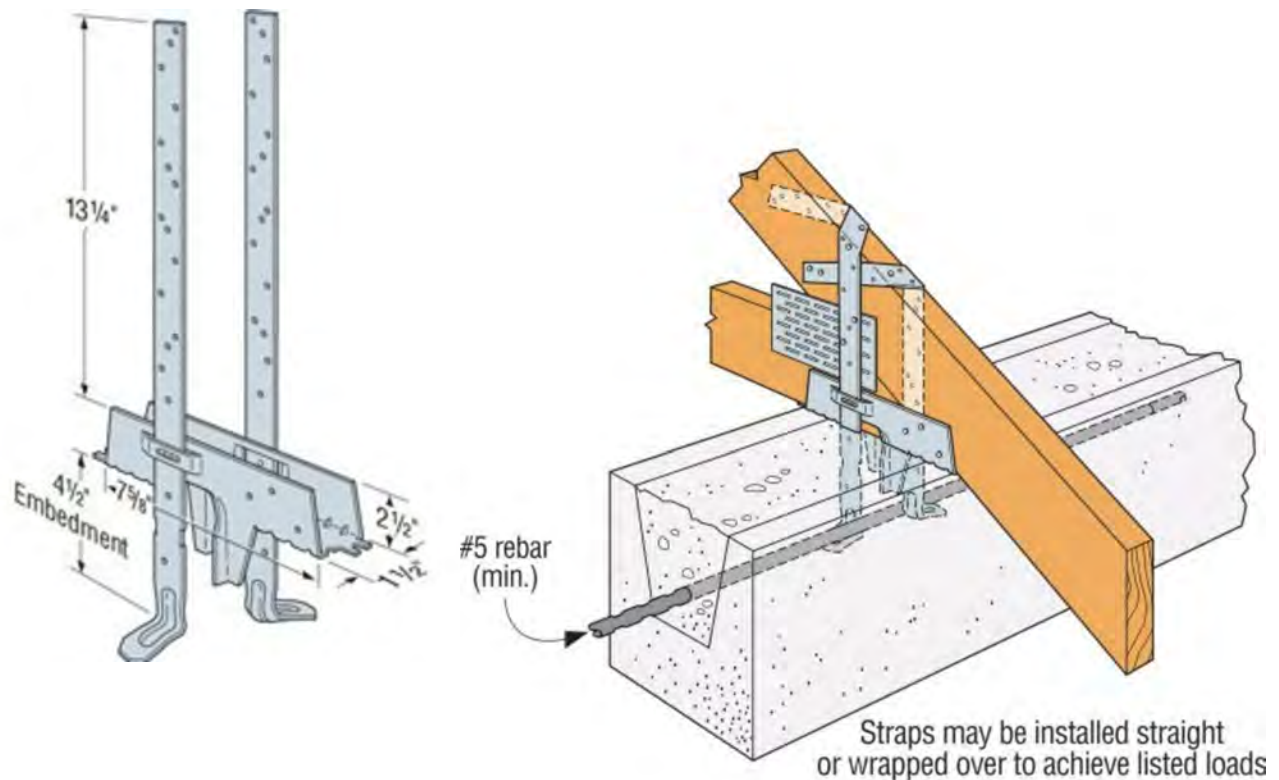

## ROOF CONSTRUCTION - POST GROUT

### Roof Connection Method for Severe Weather (Cont.)

Added  
6/28/24

1. Loads have been increased for wind or earthquake loading, with no further increase allowed. Reduce where other loads govern.
2. Concrete shall have a minimum compressive strength of  $f'_c = 2,500$  psi.
3. Grout-filled CMU (GFCMU) shall have a minimum compressive strength of  $f'_m = 2,000$  psi.
4. For simultaneous loads in more than one direction, the connector must be evaluated using either the Unity Equation or the 75% Rule, as described in **Straps and Ties General Notes**.
5. For double META installations, install half of the required fasteners in each strap.
6. F, lateral loads listed for double META on 2- or 3-ply rafter/truss may cause an additional 1/16" deflection beyond the standard 1/8" limit where the straps are installed not wrapped over the heel as shown.
7. Minimum edge distance for META is 1 1/2" for concrete and 2" for masonry. Where edge distance is less than 2" for masonry, the maximum uplift load is 1,005 lb.
8. It is acceptable to use a reduced number of fasteners provided that there is a reduction in uplift allowable load. Calculate the connector allowable load for a reduced number of nails as follows: Allowable Load = (No. of Nails Used) / (No. of Nails in Table) x Table Load. Lateral loads require the lowest 6 nail holes filled for META.
9. Fasteners: Nail dimensions in the table are listed diameter by length. For additional information, see **Fastener Types and Sizes Specified for Simpson Strong-Tie Connectors**.

### Sill Gasket Material



META 20's are inexpensive

**FASTENERS PLUS**  
FIND IT FAST. GET IT FAST.

What can we help you find?

SIMPSON CONNECTORS FASTENERS TOOLS & ACCESSORIES BRANDS BUSINESS SOLUTIONS SALE

\$199 away from FREE SHIPPING

Home / META/HETA/HETAL/HHETA/AHEP Embedded Truss Anchors / Simpson META20 16" Embedded Truss Anchor

SKU: META20

### Simpson META20 16" Embedded Truss Anchor

☆☆☆☆☆ Review this item | 1 Question

\$1.46

QUANTITY

ADD TO CART

Accepted payments:

Ships Jul 1 when you order now

### Electrical Wire Installation

Eco Building Systems Corp. recommends homebuilders consider wiring your building project for as many conceivable wiring needs to meet current or future desires such as electrical, communication, data, cable, sound system, etc. while the building is in the construction phase to minimize costs. We also strongly encourage homebuilders to plan ahead for possible future expansions by installing penetrations and/or chases during initial construction where they may eventually be required. A little extra cost for materials and labor in this phase versus "big money" adding wiring after the project is finished is worth considering during your design phase.

Electrical design begins in the design phase. Electrical service entry into the building must be decided in the design phase to either provide roof or wall service entry or underground conduit into the building.

As in conventional building, installation of electrical wiring must be completed prior to the application of drywall, plaster, or interior cladding.

**Builder's Tip:** EBS recommends that once your wiring, plumbing, and any other under finish installations are complete and before the drywall or plaster is installed that you photograph and catalog each wall's installation for a permanent record of locations of installed service.

To install Romex wire in ICCF walls without conduit:

- Map out from your plans each circuit run and box location on the ICCF wall IAW applicable codes.
- **Builder's Tip:** Use a bright marking spray paint to rough mark switch box locations and circuit runs to receptacles on ICCF walls. Then score the outline of your switch boxes and receptacles and your electrical runs with a keyhole saw. The paint highlights the scored line making it easy to cut your box openings and wire chases.
- **Alternative technique:** We prefer to use metal boxes over plastic. Both will work, but the metal boxes are more durable and can be flipped over and tapped with a hammer to score an imprint of the box for quick plunge cutting with a chainsaw. Metal boxes can be used with Romex or conduit.
- Cut your box openings and wire chases with an electric chain saw. Make a visible 2" depth line on the chainsaw bar to cut to the proper depth. Do not be concerned if you hit concrete. Use of 2" deep metal boxes is recommended.
- Single wire chases should be only wide enough to snugly hold the Romex wire and must be at least 2" deep to comply with applicable codes (Romex must be deeper than 1 1/4" deep). Avoid cutting chases with sharp 90-degree bends, round (sweep) all your bends with at least a 3-6" radius.

## WALL CONSTRUCTION - POST GROUT

### Electrical Wire Installation (Cont.)

UPDATED 5/15/19

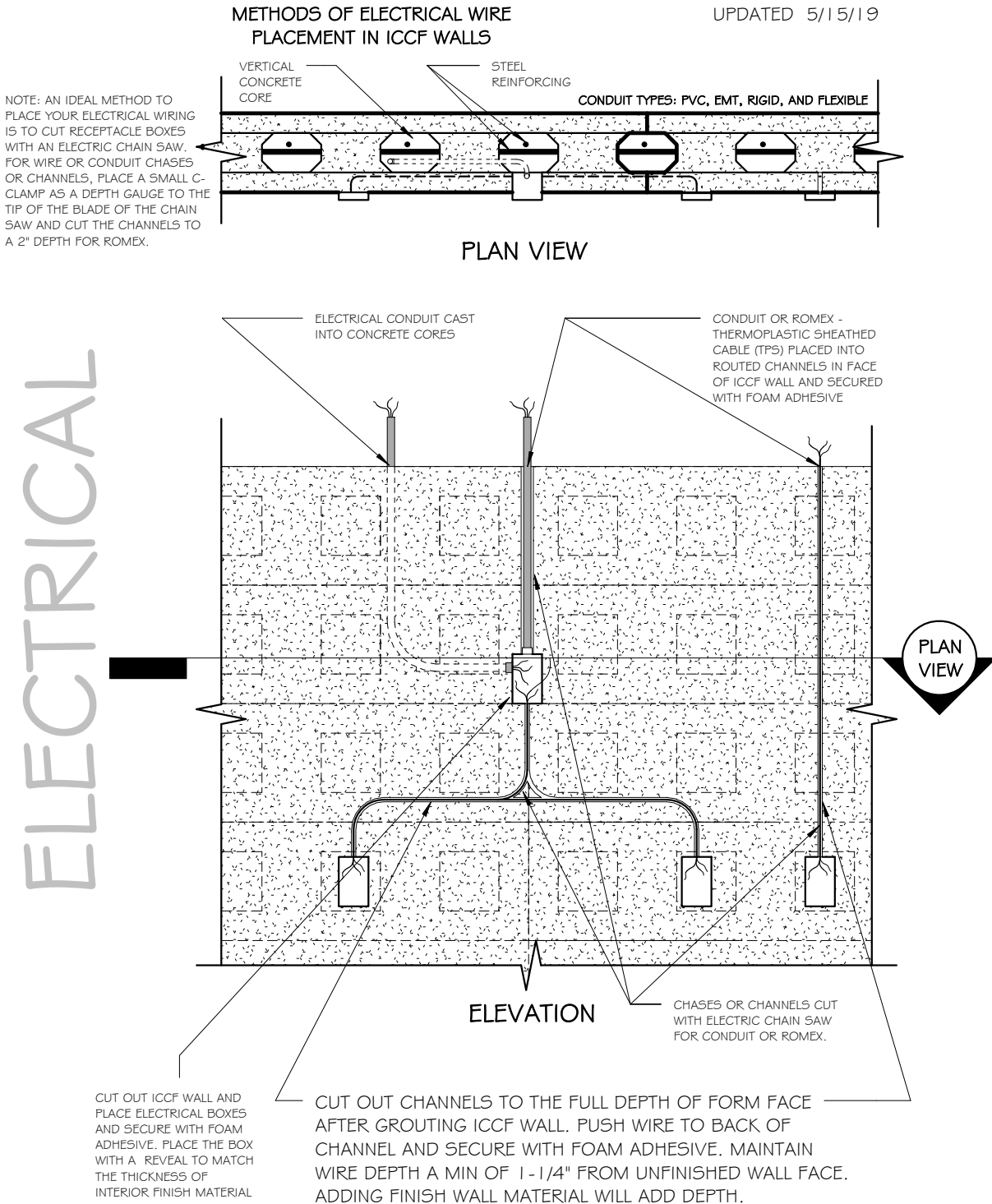

## ELECTRICAL PLACEMENT/ICCF WALL

NOT TO SCALE

Figure 9.1

## WALL CONSTRUCTION - POST GROUT

### Electrical Wire Installation (Cont.)

METHODS OF ELECTRICAL WIRE  
PLACEMENT IN ICCF WALLS



ROMEX - THERMOPLASTIC SHEATHED CABLE (TPS) PLACED INTO ROUTED CHANNELS IN FACE OF ICCF WALL AND SECURED WITH FOAM ADHESIVE

PHOTO OF A MOCK UP OF ELECTRICAL WIRING INSTALLATION INTO THE FACE OF AN ICCF WALL

EMT CONDUIT PLACED INTO WIDER ROUTED CHANNELS IN FACE OF ICCF WALL AND SECURED WITH FOAM ADHESIVE

NOTE: AN IDEAL METHOD TO PLACE YOUR ELECTRICAL WIRING IS TO CUT RECEPTACLE BOXES WITH AN ELECTRIC CHAIN SAW. FOR WIRE OR CONDUIT CHASES OR CHANNELS, PLACE A SMALL C-CLAMP AS A DEPTH GAUGE TO THE TIP OF THE BLADE OF THE CHAIN SAW AND CUT THE CHANNELS TO A 2" DEPTH FOR ROMEX.

## WALL CONSTRUCTION - POST GROUT

### Electrical Wire Installation (Cont.)

The blunt end of a wood shim is a good tool to press the Romex deep into your cut chases and a shot of polyurethane foam adhesive every few inches will ensure that the Romex will remain securely seated in the chase.

**Builder's Tip:** To cut wire chases rapidly into ICCF walls, use an electric chainsaw. Make a visible 2" depth line on the chainsaw bar to cut to the proper depth. Do not be concerned if you hit concrete. Use of 2" deep metal boxes is recommended.

The kerf thickness of a chainsaw bar works well to hold 14 GA and 12 GA Romex. As you run your Romex into the cut chase, gently seat the wire well into the chase with the blunt end of a shim and use a bead of foam adhesive to secure the wire.

Recessed box openings should be cut to hold the electrical boxes snugly and be only as deep as necessary, leaving a reveal for the box faces to be flush with the chosen interior wall finish when installed.

Secure electrical boxes with adhesive foam.

**Builder's Tip:** To protect single runs or bundles of electrical wires or plumbing with a long **nail stop**, a simple and inexpensive way to protect these runs is to purchase 8' or 10' sticks of 16 gauge metal framing sill track ("C" Channel) from a metal framing building supply. The sill track comes in 2X3 and 2X4 widths and can be used to protect long runs of wire as well as PEX or copper plumbing.

To use the sill track as a long **nail stop** for long runs of wires, cut the sill track to the length of the run and flip it over to the face of the wall over the run and gently tap the edges of the sill track with a hammer to make an imprint in the wall. Use your chainsaw or a thin disc grinder and cut a 2" deep kerf over each imprint from the sill track. Shoot spray foam adhesive in each kerf, and tap the sill track into the kerfs until flush with the face of the wall. The 16 GA metal track will deter any screw or nail damage to the electrical wires.

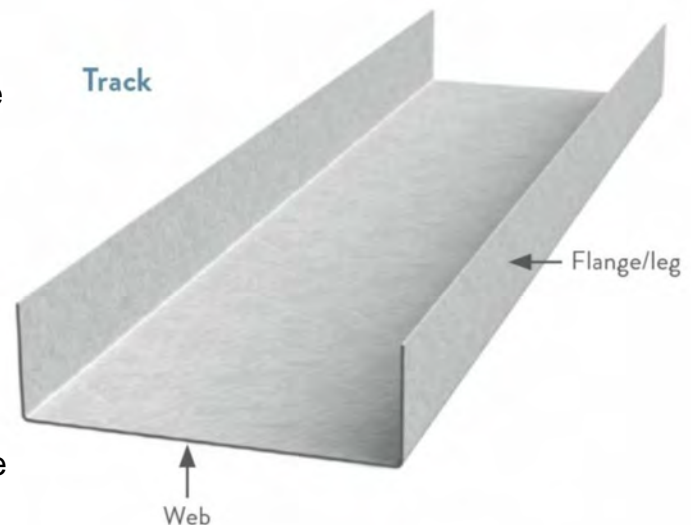

Changed  
10/01/25

### Electrical Conduit Installation

To install electrical wire in ICCF walls in conduit, the method is similar to Romex installation but the chase cut would be larger for the increased diameter of electrical conduit. Refer to Plumbing Installation for further guidance.

## **WALL CONSTRUCTION - POST GROUT**

### **Plumbing Installation**

Plumbing design, like electrical design begins in the design phase. Plan for the most efficient way to supply water and remove waste in your building design. For ICCF walls, running large or multiple plumbing pipes through the ICCF walls should be avoided if possible. Effort should be made to run most plumbing through 2x6 interior partition walls or through attic or open web truss floors.

Chases for small plumbing pipe may be cut in an ICCF wall in a similar manner to electrical wire installations. The interior ICCF layer will accommodate installation of pipe up to 2" O.D. without touching concrete. For pipe larger than 2" O.D., EBS recommends installation in an interior vertical core of the ICCF block before grouting the wall or in a framed partition wall if possible or a conventionally framed chase.

- To secure pipe in a chase cut into ICCF, seat the pipe in the bottom of the chase and wedge tight with wood shims then secure with foam adhesive.
- Replace insulation around plumbing with a bead of adhesive foam, as desired.

## WALL CONSTRUCTION - POST GROUT

### Plumbing Installation (Cont.)

NOTE: AN IDEAL METHOD TO PLACE PLUMBING WITHIN AN ICCF WALL IS TO CUT CHASES OR CHANNELS IN THE WALL WITH AN ELECTRIC CHAIN SAW, PLACE A SMALL C-CLAMP AS A DEPTH GAUGE TO THE TIP OF THE BLADE OF THE CHAIN SAW AND CUT THE CHANNELS TO A 2" DEPTH.

### METHODS OF PLUMBING PLACEMENT

UPDATED 04/03/19

PLASTIC PIPE MAY BE PLACED EITHER WITHIN THE WALL OR EMBEDDED IN THE SURFACE

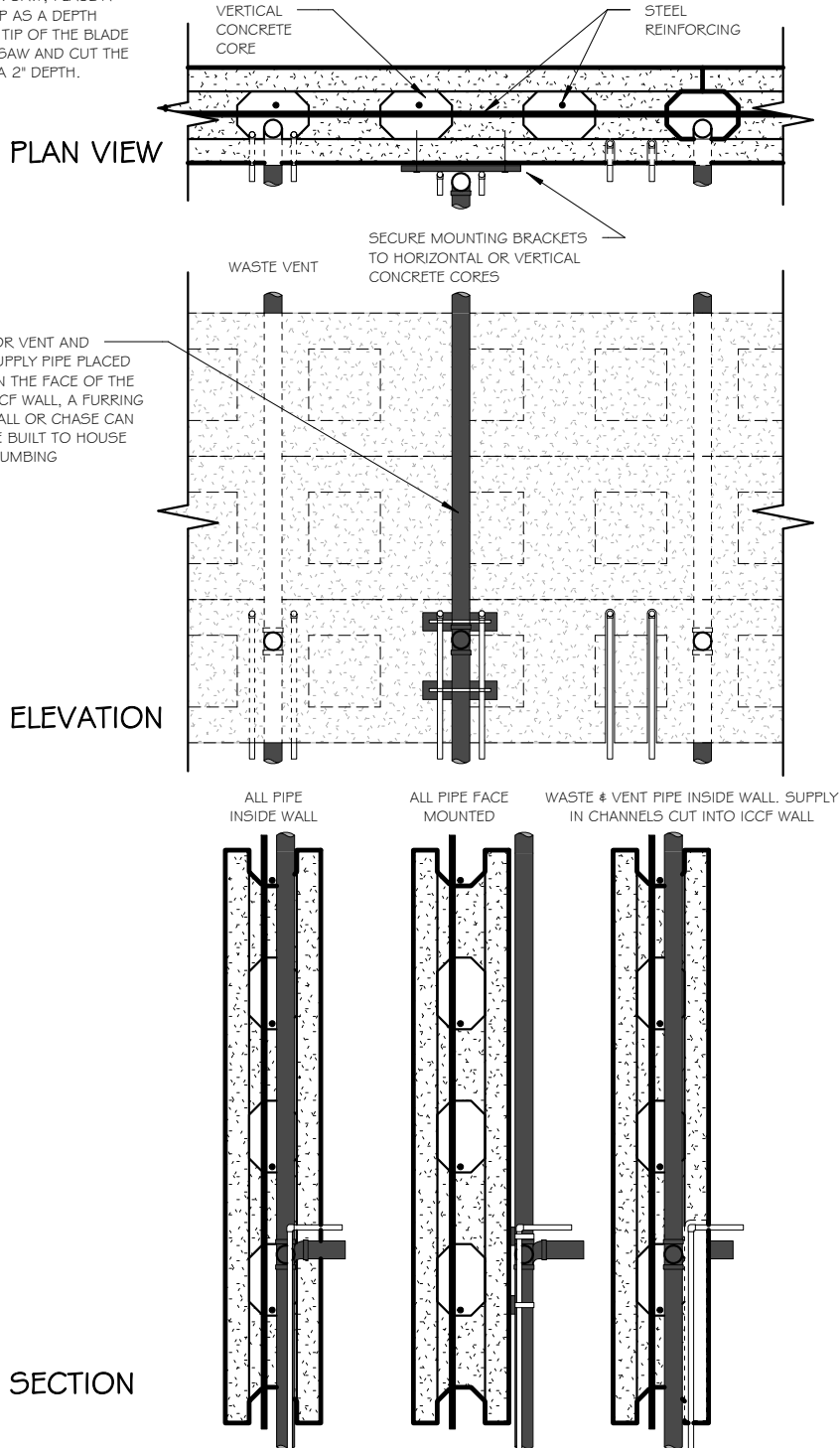

PLUMBING

## PLUMBING PLACEMENT/ICCF WALL

NOT TO SCALE

Figure 9.2

## Plumbing Installation (Cont.)

As in conventional building, installation of plumbing must be completed prior to the application of drywall, plaster, or interior cladding.

**Builder's Tip:** EBS recommends that once your wiring, plumbing, and any other under finish installations are complete and before the drywall or plaster is installed that you photograph and catalog each wall's installation for a permanent record of locations of installed service.

## Framed Partition Wall Attachment to ICCF Wall

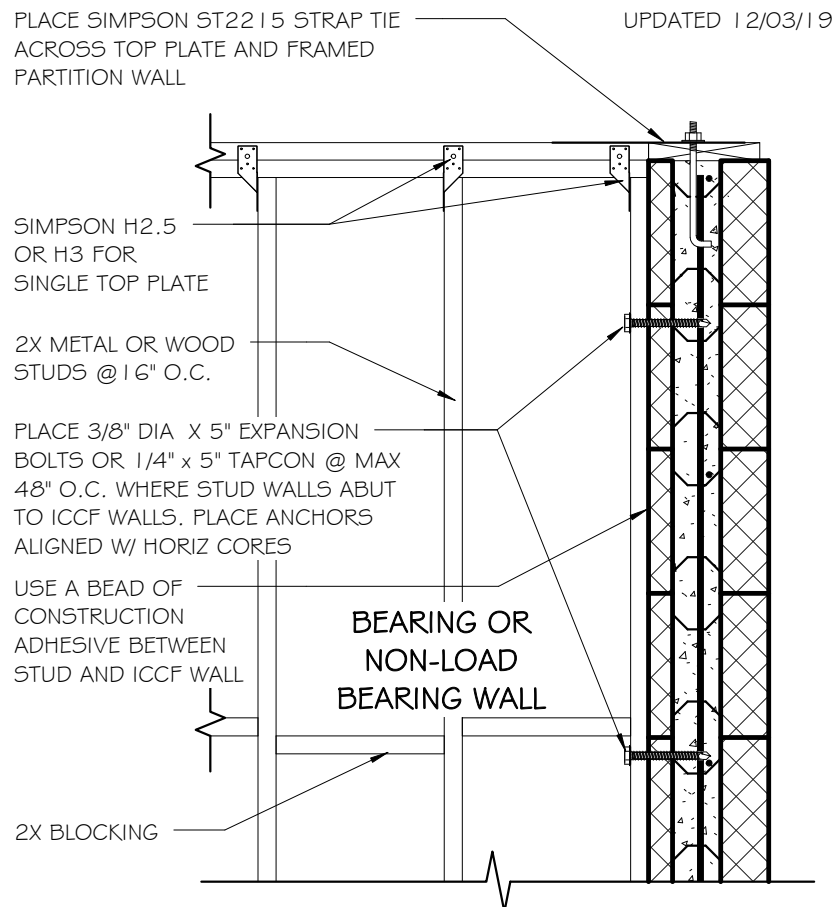

## STUD WALL ATTACHMENT TO ICCF WALL

SCALE: 3/4" = 1'-0"

Figure 9.3

## **Attachments and Wall Finishes**

### **Attachments**

In our experience, a question has been raised about "how do you attach or hang things with significant size and weight from ICCF walls?"

The following are some suggested methods to answer that question.

First let's assume you are cladding the interior face of the wall with gypsum board.

For lightweight things like small picture frames and towel racks, etc., gypsum board and ICCF can hold just about anything weighing 30-50 pounds with ordinary drywall anchors or toggles depending on the application.

For heavier things like big mirrors, paintings, bathroom grab bars, etc., a wood or metal nailer that is "let in" is recommended. "Let in" means that you have removed or routed out ICCF material the width, length, and depth of the nailer you have chosen and the face of the nailer is now flush with the face of the unfinished wall (an electric chain saw makes quick work of digging out ICCF material). The nailer can be a 1x2, 1x3, 1x4, plywood or OSB, or 2x, or greater depending on the application. The nailers for heavier things are placed prior to finishing your interior with drywall or plaster.

To attach the nailer to the wall, this can be planned in the design phase if you know exactly where you need the nailer. If you don't know exactly, then you can attach prior to or after grout pour. We will discuss each method.

In the design phase or prior to grout pour you can secure the nailer with blue screw Tapcons, hot dipped galvanized spiral nails or landscape spikes, or small anchor bolts that attach to the nailer and penetrate the ICCF cores so when the walls are grouted, the concrete embeds the fastener and the nailer is secured permanently to the concrete cores in the wall. Lag bolts, threaded rod, etc. can be used as alternative anchors into the cores also. If you are not certain of the exact position you will need the nailer placed, use larger nailers to expand the target area for your hangers.

If the walls are already grouted, then determine placement for the nailer, "let-in the nailer, place the nailer as described above and use Tapcons or "redheads" or similar concrete fasteners of sufficient length to penetrate the nailer, through the inner ICCF wall to reach a flat face area of the concrete vertical or horizontal cores. Use the ICCF block edges to pinpoint the location of the center of the concrete cores to drill for the fasteners.

Another method for attachment after the grout pour that doesn't require a concrete fastener: Locate a block web (an area between vertical and horizontal cores that has no concrete) that coincides with your nailer and drive a threaded rod through the wall. Secure the rod to the nailer with a washer and nut counterbored into the nailer. Secure the other end of the rod with a "let in" 3" x 3" or greater scab (small flat piece of wood, backer board, or metal bearing plate) and a washer and nut that is in a depressed area below the exterior face of the wall so that it won't interfere with your exterior finish when it is applied.

## Attachments and Wall Finishes

### Attachments

This is a good example of a series of 1x4 "let-in" nailers for a kitchen wall that will have kitchen base and wall cabinets of varying heights installed. The nailers would need to be placed in the wall to align with the cabinet rails or hanging rails in the back of the cabinets to attach the cabinets to the nailers with screws.



This is a photo of nailers for full wall cabinets that are not "let-in" but are "sitting proud" on the wall surface.

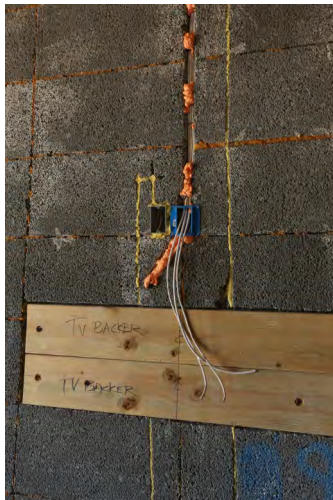

This is a photo of nailer for a big screen TV.

## Attachments and Wall Finishes (cont.)

UPDATED 1/06/20

### FOR PLACEMENT BEFORE GROUTING

ANCHOR MAY BE A SPIRAL NAIL OR LANDSCAPE SPIKE, TAPCON, ANCHOR BOLT, LAG BOLT, 1/4" OR 3/8" THREADED ROD W/ NUT AND WASHER. PLACE BEFORE GROUTING CORES AND PLACE SO ANCHOR PENETRATES A VERTICAL CORE FOR MINIMUM 2" EMBEDMENT. PLACING ANCHORS ALIGNED W/ VERTICAL CORES ALLOWS FOR SECURING NAILER AT ANY WALL HEIGHT

WOOD NAILER, 1X2, 1X3, 1X4, OSB, OR 2X NAILER TO ACCOMMODATE COUNTERBORE OR COUNTERSINK FOR ANCHORS

USE SPRAY FOAM ADHESIVE TO GLUE IN NAILERS IN ADDITION TO MECHANICAL FASTENERS FOR ADDED STRENGTH

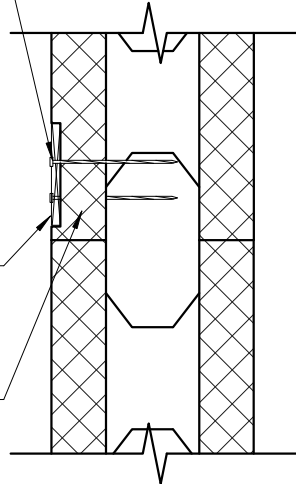

### FOR PLACEMENT AFTER GROUTING

PLACE MINIMUM 1/4" DIA X 3-1/2" TAPCON OR CONCRETE EXPANSION BOLTS @ MAX 48" O.C.. PLACING ANCHORS ALIGNED W/ VERTICAL CORES ALLOWS FOR SECURING NAILER AT ANY WALL HEIGHT

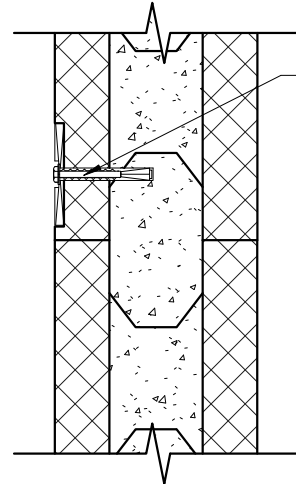

## "LET IN" NAILER INSTALLATION

NOT TO SCALE

Figure 9.4

### FOR PLACEMENT AFTER GROUTING

UPDATED 1/06/20

- THREADED ROD THROUGH ICCF W/O CONTACTING CONCRETE

USE SPRAY FOAM ADHESIVE TO GLUE IN NAILERS IN ADDITION TO MECHANICAL FASTENERS FOR ADDED STRENGTH

2X NAILER TO ACCOMMODATE COUNTERBORE FOR ANCHORS

1/4" OR 3/8" THREADED ROD W/ NUTS AND WASHERS DRILLED THROUGH ICCF WEB

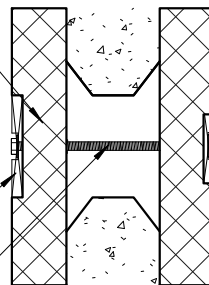

SCRAP WOOD BLOCK, 1X OR 1/2" OSB, 3"X3" SQUARE OR GREATER

## "LET IN" NAILER, THREADED ROD & SCAB

NOT TO SCALE

Figure 9.4a

## Wall Finishes

There are countless finishes to clad the interior and exterior of ICCF walls. For brevity, in the next paragraphs, we will only discuss drywall for the interior and stucco for the exterior because these are the finishes that are most prevalent in the southwest United States.

## Attachments and Wall Finishes (cont.)

### Drywall

Drywall can be applied directly to the ICCF wall with general purpose drywall joint compound as an adhesive. Use a 1/4" or 3/8" notched trowel to apply the joint compound. The drywall "mud" can be applied to the ICCF wall or the drywall sheet. Coat the entire back of the sheet or wall or coat in patches or strips 12" - 16" O.C. Apply the "battered" drywall sheet to the wall or sheet to the "battered" wall and support with a couple of "deadmen" (2x4's nailed in a "T" to wedge under the sheet) cut to size to wedge under sheet if applying horizontally and a "top to bottom" application. Use sized wedges for bottom of sheet support to provide a gap above the floor if applying drywall vertically. Nail with drywall nails the upper edge of the drywall to the single top plate for additional support until the drywall mud dries. A scrap 2X4 with carpet attached and a rubber mallet is good to use to tap the drywall sheet after applying it to the wall to set the drywall mud well into the ICCF.



Use all-purpose drywall mud as your adhesive



You can fully mud the wall or the back of the board



Or you can spot mud the board

## Attachments and Wall Finishes (cont.)

Note: For waterproofing ICCF walls below grade, refer to pages 6.5f and 6.4g. Below grade waterproofing is very different from above grade waterproofing,

### Stucco

Stucco adheres directly to the ICCF without additional layers of foam or lath, saving substantial costs from the extra materials and labor that is eliminated with this application method. Make sure your stucco contractors are made aware that your walls require only stucco and not all the other required steps and materials and installation labor in an Exterior Insulation and Finish Systems (EIFS) stucco system which is a stucco cladding system of many layers of other materials designed to allow cement to cover wood framed walls. All those additional layers of material are not required for ICCF and your bids for stucco should reflect those cost savings.

**Builder's Tip:** As an alternative to plaster, we have in the past had our stucco contractors, "stucco" the interior walls with stucco and use a "hard troweled" finish to simulate plaster. If this sounds like something you might want to do, ask your stucco contractor if they can do this and have them bid your job to include the interior wall faces of ICCF.

**Editor's Note:** The following article on the next few pages, is an excellent description of the differences between a hard stucco finish and an Exterior Insulation Finish System (EIFS) written by the VERTEX Co..

### **Hard Stucco for ICCF**

EBS comments:

The bottom-line is: a hard stucco finish is ideal for cement based, hard immovable structures like gray block ICCF, concrete, and CMU walls. A hard stucco finish is never a skim coat.

Acrylic stuccos and EIFS systems are meant for wood framed structures that constantly flex, move, expand and contract at different rates from cement stuccos. The stucco finish must be separated by many layers of rigid foam, lath, tar paper, scratch coat, etc. to minimize cracks from wall movement. The elastomeric finishes minimize or hide cracks in the stucco from all the flexing.

Please read the article from **VERTEX** below. **VERTEX** is a full-service construction company with expertise in completion contracting, tenant improvement, pre-construction, general contracting, engineering design-build, reconstruction, restoration, and deconstructive testing.

**VERTEX** does the best job I've seen, explaining the differences between a hard stucco finish and acrylic stuccos and EIFS systems.

## Attachments and Wall Finishes (cont.)

### Editor's Note (cont.)

<https://vertexeng.com/insights/hard-coat-stucco-vs-eifs-synthetic-stucco-1/>

<https://vertexeng.com/insights/hard-coat-stucco-vs-eifs-synthetic-stucco-2/>

If you were to ask a home or building owner whether the exterior of their building was covered with stucco or EIFS, you may get a confused response. Most people would probably tell you it's stucco. From the outside, they may look the same, but structurally, they are two very different types of finishes. In this two-part series, we will take a look at the structure, installation, advantages, and disadvantages of each finish.

### WHAT ARE STUCCO AND EIFS?

Stucco <<http://www.cement.org/learn/materials-applications/stucco>> and EIFS <<http://www.eima.com/eifs>> are two similar looking exterior wall cladding finishes. Stucco is a traditional material and process that has been around for centuries all over the world. Exterior Insulation and Finishing System (EIFS) was invented in Europe after World War II to repair and insulate the exterior of damaged buildings and was introduced in the USA in the 1960s as an exterior wall option. EIFS (Pronounced "eefs", "eefis" or "E.I.F.S."... there's no wrong way to say it) mimics stucco and is sometimes called "synthetic stucco." Stucco and EIFS are commonly installed on single family homes, townhomes and low/mid-rise commercial/residential buildings. These cladding options are most often placed over framed walls with sheathing but can also be applied over concrete and masonry.

### STUCCO

- Also called "Hard Coat Stucco" and "Exterior Plaster"
- Definition: "An exterior finish composed of some combination of Portland cement, lime, and sand, which are mixed with water, which dries to a very hard textured finish" [1]
- Design Concept: Protects the underlying building components from the weather with a concealed weather-resistant barrier water management and drainage system via:
  - o Weather Resistant Barrier installed on the building's sheathing
  - o Flashing and weeps to direct water that may get behind the face of the stucco harmlessly to the exterior

### TYPES OF STUCCO

- Traditional "Three-coat" stucco system (most common). When installed to meet the building code, these systems are a minimum of 7/8 inch thick
- "One" or "Two-Coat", proprietary systems are also available (must be approved to meet code). These systems may be as thin as 3/8 inch.

### ADVANTAGES OF STUCCO

- Impact and fire resistance
- Durable in a variety of climates
- Low maintenance
- Design flexibility (exterior trim, cornices, keystones, friezes, soffits, etc.)

## Attachments and Wall Finishes (cont.)

### Editor's Note (cont.)

#### STUCCO INSTALLATION

Residential stucco systems in most areas of the country are installed over wood or metal framing and wood or gypsum sheathing. The sheathing is required by the building code's referenced standards to be covered with 2 layers of a water-resistant barrier ("WRB") sheet on a roll. Over the WRB a wire mesh or "lath" is stapled or nailed to the sheathing.

Integrated between the WRB and the wire mesh should be flashing and weeps, which are mechanisms to direct water away from the sheathing and the building interior. Stucco can also be accessorized with expansion and termination joints to help keep the stucco from cracking and proper sealants. Stucco systems should only be installed as designed by a registered design professional or according to the manufacturer's instructions and must comply with the building code.

Over the wire mesh, flashing, and accessories, the coats of cement plaster are installed, usually in three coats. The first or base coat commonly called the "scratch coat" is intended to "key in" to the mesh (to hold it on the building). The second coat, also known as the "brown coat," is trowel applied uniformly and flat to provide a smooth surface for the finish coat. Finish coats are typically thin and may be made with tinted cement plaster or be an acrylic / elastomeric troweled coating. Stucco systems are governed by building codes and referenced standards, most notably within the International Residential Code, Chapter 7.

#### PROBLEMS WITH STUCCO

- **Cracks** may form from a variety of reasons, some within the applicator's controls, such as proper flashing and sealing, proper thickness, and curing procedures. Building movement and settlement, as well as expansion and contraction, also cause stucco to crack and are usually beyond the installer's control.

- **Water Intrusion** can occur from cracks but also when the stucco system cannot drain incidental water which penetrates its face layer and becomes trapped within the building walls, leading to damages to building components. This can be caused by both improper design, oversight, and installation.

Stucco systems have been successfully installed in countries where masonry materials are generally used, while residential construction materials in the United States are commonly wood-based (e.g. dimensional framing, engineered materials, paper-faced gypsum). Wood fiber-based materials readily support mold growth and decay when exposed to elevated moisture levels.

In part two of this series, we will take a closer look at the structure, advantages, and disadvantages of EIFS; otherwise known as synthetic stucco.

To learn more about VERTEX's Forensic Consulting services or to speak with a Construction Expert, call 888.298.5162 or submit an inquiry [<https://vertexeng.com/submit-a-request/submit-general-inquiry/>](https://vertexeng.com/submit-a-request/submit-general-inquiry/).

Previously, we discussed the advantages and disadvantages of traditional hard coat stucco [<https://vertexeng.com/blog/hard-coat-stucco-vs-eifs-synthetic-stucco-1/>](https://vertexeng.com/blog/hard-coat-stucco-vs-eifs-synthetic-stucco-1/). In the second part of this series, we will discuss the structure, installation, advantages, and disadvantages of EIFS [<http://www.eima.com/>](http://www.eima.com/); otherwise known as synthetic stucco.

## Attachments and Wall Finishes (cont.)

### Editor's Note (cont.)

To learn more about VERTEX's Forensic Consulting services or to speak with a Construction Expert, call 888.298.5162 or submit an inquiry

<<https://vertexeng.com/submit-a-request/submit-general-inquiry/>>.

Previously, we discussed the advantages and disadvantages of traditional hard coat stucco <<https://vertexeng.com/blog/hard-coat-stucco-vs-eifs-synthetic-stucco-1/>>. In the second part of this series, we will discuss the structure, installation, advantages, and disadvantages of EIFS <<http://www.eima.com/>>; otherwise known as synthetic stucco.

#### EXTERIOR INSULATION AND FINISHING SYSTEM (EIFS)

- Pronounced “**eefis**” or “**eefs**”, both are correct... Just don't call it stucco!
- Definition: According to the International Building Code and ASTM International, an Exterior Insulation and Finish System (EIFS) is:
  - o A non-load bearing, exterior wall cladding system that consists of
  - o An insulation board attached either adhesively or mechanically, or both, to the substrate;
  - o An integrally reinforced base coat;
  - o And a textured protective finish coat.
- First introduced in the United States in the 1960s [was first used in Europe after WWII to insulate rebuilt older masonry structures].
- Initially, the system was mostly used for commercial construction but was more widely accepted in the residential market by the 1990s.
- In the mid-1990s, it was discovered that many EIFS clad homes and buildings had water damage. Poor penetration detailing and lack of a drainage mechanism was to blame.
- Flawed design concept and subject of construction defect litigation to this day.
- In the 2000s, the industry standards for installation were greatly improved, and overall confidence in the system returned, but many designers still avoid it.

#### TYPES OF EIFS

- Class “PB” EIFS (most predominant EIFS system). “PB” means a cementitious “polymer-based” system
  - o EIFS - Designed as a “Barrier System” - Designed to repel all water at the face of the cladding
  - o EIFS with Drainage - Designed to shed or drain penetrating water

#### ADVANTAGES OF EIFS

- Adds R-value (Insulation) to the building envelope
- Design Flexibility
- Low maintenance
- Simpler than Stucco

## Attachments and Wall Finishes (cont.)

### Editor's Note (cont.)

#### EIFS INSTALLATION

EIFS is installed typically over wood or metal framing and wood or gypsum sheathing, and also over concrete and masonry. Building codes and referenced standards govern the installation of EIFS in the International Residential Code, Chapter 7. Barrier EIFS is not permitted to be installed over framed wall assemblies, only over concrete and masonry. EIFS with drainage must include a weather-resistant barrier and meet drainage efficiency standards, usually provided in a manufacturer designed systems. WRB's over framed walls can either be sheet barriers or liquid applied water barriers and will dictate how the EIFS is installed on the building. The insulation board (usually a white foam board about 1.5 inches thick) is either mechanically attached or adhesively attached, depending on the weather barrier. It is critical to include drainage space between the WRB and the back of the insulation board. The insulation board is then covered with a reinforcing mesh, trowel embedded in the polymer modified cement base coat. The application technique is similar to stucco. Over the cured mesh and base coat, an acrylic finish coat is trowel applied. The total thickness of EIFS "Lamina" is generally 1/16" to 1/8" but can be thicker in areas of high-impact, by using high impact resistant mesh. Similar to stucco it is important to follow a proper design by a registered design professional or the EIFS manufacturer. Important considerations include the drainage plane, flashings, and properly designed and installed sealant joints at penetrations, areas prone to movement, and dissimilar materials.

#### PROBLEMS WITH EIFS

##### **1. As-built details are not in accordance with the approved drawings, referenced or industry standards or manufacturer installation requirements.**

- EIFS has been installed as a "Barrier System" without drainage over framed walls
- Expansion and sealant joints improperly or not installed
- Flashing incorrectly or not installed. Especially kickout flashing
- These deficiencies can cause damages

##### **2. Water Damage from Lack of Drainage.**

- Water intrusion and associated damage rarely occur at the field of an EIFS wall plane. Water intrusion comes from:
  - o Poorly sealed penetrations
  - o Missing or incorrect flashing
  - o Lack of drainage
  - o Improperly installed WRB

Although drainable EIFS is not a "Barrier System", and is capable of managing incidental moisture, too often poorly sealed conditions allow too much water to reach the WRB, overwhelming the system and trapping water. Just as with stucco, make sure the system can drain properly.

## Attachments and Wall Finishes (cont.)

### Editor's Note (cont.)

#### 3. Lamina Cracking

- As with stucco, cracks can allow water infiltration and can cause damages
- Foam trim needs an extra layer of mesh at wall transitions to guard against cracking
- Cracking adjacent to trim typically relates to inadequate mesh installation
- Floor line expansion joints are recommended to guard against cracking from lumber shrinkage

#### HOW CAN VERTEX HELP?

Stucco and EIFS are highly aesthetically appealing exterior cladding options that are popular with designers and owners. If properly designed and installed, these systems will last for many years. Unfortunately, an inspection of these systems during installation is often not required by building codes. This lack of code compliance can cause quality control issues. When problems do arise, VERTEX has Forensic Engineers throughout the country that are ready to assist.

To learn more about VERTEX's Forensic Consulting

[services](https://vertexeng.com/services/forensics/) or to speak with a Forensic Engineering Expert [services](https://vertexeng.com/experts/), call 888.298.5162 or submit an inquiry [services](https://vertexeng.com/contact-us/).

All Rights Reserved.

A hard stucco finish is what we recommend for ICCF walls. The Perfect Block.

Added  
4/24/24



Example of brown coat Stucco material, carried by Home Depot.



Brown coat being keyed into bare ICCF block, 5/8" to 3/4" thick.

## Attachments and Wall Finishes (cont.)

### Other Cladding (Interior or Exterior)

Cultured (faux) stone, brick, and tile can be applied directly to ICCF walls with Thinset mortar or manufacturer's recommended mortar, similar to the method used to apply drywall.

Actual stone or brick will require a support foundation (brick ledge or secured angle iron) and brick ties imbedded in the ICCF grout. Both stone and brick can be mortared directly to the ICCF wall.

For clapboard siding, wallboard, vinyl siding, etc., metal furring strips, commonly called "hat channel" can be secured to the ICCF wall grout to carry the load of such cladding types if compatible with the siding manufacturer's installation instructions. Or wood or metal furring strips compatible with the siding manufacturer's installation instructions can be installed with spiral nails or landscape spikes, long enough to penetrate the strip, the ICCF wall and an inch or more into the block core before grouting with concrete. A hot dipped galvanized spiral landscape nail/spike is a good fastener to use to embed in the grout. If installing after the grout has been poured and hardened, the strip can be secured into the cores with concrete fasteners of the appropriate length. (Figure 9.5)



(Figure 9.5) Photo of a display, illustrating faux stone and tile applied directly to the block with Thinset mortar. The block just below, shows the bare block (illustrating the texture of the face of the block), a stucco "brown" coat (actually gray in color) applied (keyed) directly into the block texture, and two different examples of finish coats (Monterey and Sand finishes). These applications on bare ICCF block require no additional layers of foam or chicken wire (lath) and tar paper, saving material and installation costs.

Changed  
4/08/22

## Attachments and Wall Finishes (cont.)

### FOR PLACEMENT BEFORE GROUTING

STEEL HAT CHANNEL OR PT WOOD FURRING STRIP THAT MEETS REQUIREMENTS FOR USE BY CLADDING MANUFACTURER'S SPECIFICATIONS

ANCHOR FURRING STRIP BEFORE GROUTING WITH A HOT DIPPED GALVANIZED SPIRAL LANDSCAPE SPIKE.

PLACE BEFORE GROUTING CORES AND PLACE SO ANCHOR PENETRATES A CORE FOR MINIMUM 1 1/2" EMBEDMENT.

PLACING ANCHORS ALIGNED W/ HORIZONTAL CORES ALLOWS FOR SECURING FURRING STRIP AT 12", 24" OR GREATER O.C. ATTACHMENT (PLACING SPIKES AT BLOCK SEAMS, CENTERS SPIKES WITHIN THE HORIZ CONCRETE CORES).

PLACING ANCHORS ALIGNED W/ VERTICAL CORES ALLOWS FOR ANY DESIRED SPACING OF ANCHORS.

### FOR PLACEMENT AFTER GROUTING

TO ATTACH STRIPS AFTER GROUTING WALL, USE AN APPROPRIATE CONCRETE ANCHOR OR SCREW: 1/4" DIAMETER X 4"-6" TAPCON BLUE OR WHITE (GREATER CORROSION RESISTANCE) SCREW TO ANCHOR INTO HARDENED CONCRETE VERTICAL OR HORIZONTAL CORES

UPDATED 12/03/19

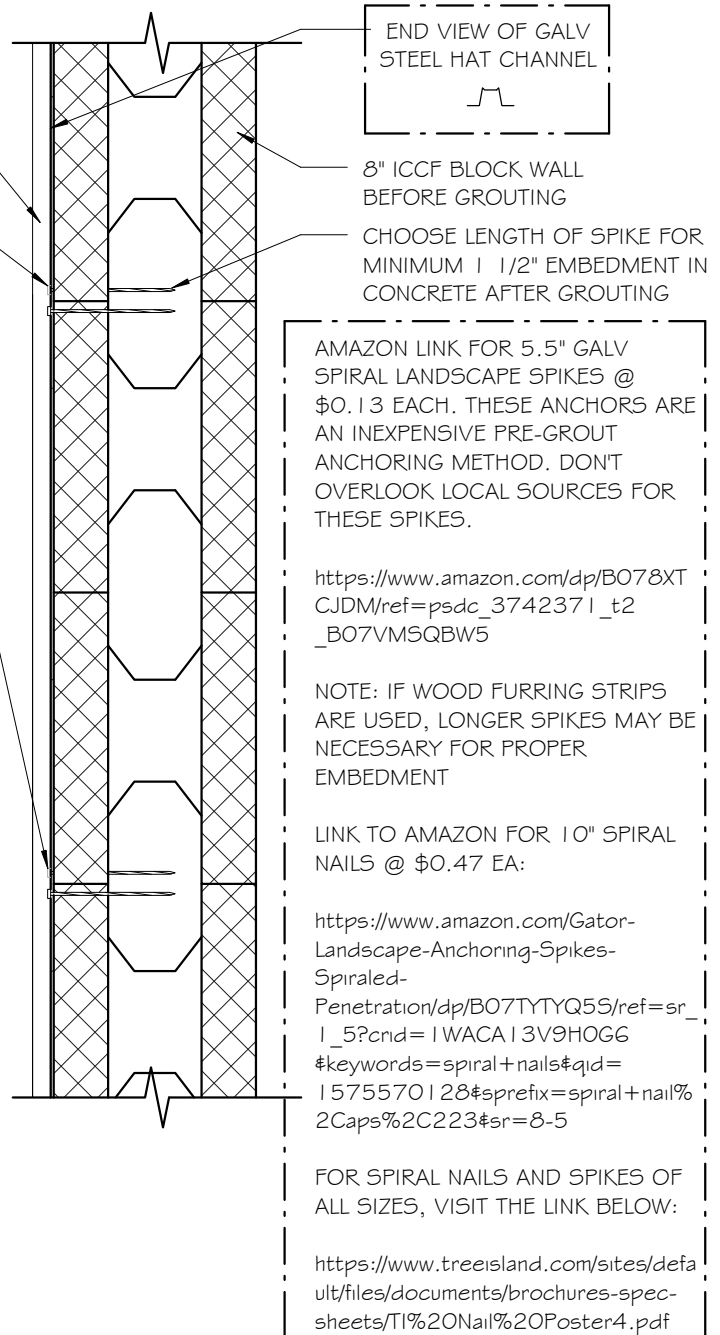

Figure 9.5

## FURRING STRIP INSTALLATION ON ICCF WALL

SCALE: 3/4" = 1'-0"

## **WALL CONSTRUCTION - FIREPROOF ICCF ROOF AND EAVE**

### **Fireproof ICCF Roof and Eave Designs**

A couple of methods to achieve an exceptionally strong and fireproof roof and eave using ICCF blocks are suggested in the following details. The ICCF roof construction is very similar to the vertical ICCF wall construction. Trusses, of varying kinds, sizes, spacing and construction are still used to support the roof. A wood top plate with anchor bolts will not be necessary. The trusses' end bearing points will rest in pockets that are "bucked" in the ICCF wall and will bear on concrete. The trusses' top chord will be aligned with the top of the wall. "B" deck panels, corrugated steel panels will be used in lieu of roof sheathing or in addition to roof paneling for an esthetic look if the trusses are exposed and a cathedral ceiling is desired. The B deck panels, running perpendicular to the trusses can be placed to extend beyond the top of the ICCF wall to create a fireproof eave and prevent "fire creep" into a soffit vented attic space. This design requires an unvented attic. B deck comes in several different gauge thicknesses which will allow increasing the interval between common trusses, engineered for the additional concrete load, when using thicker gauge B deck. Heavy timber trusses, engineered for the additional loads, can be placed at greater intervals when an exposed truss look is desired.

## WALL CONSTRUCTION - FIREPROOF ICCF ROOF AND EAVE

### Fireproof ICCF Roof and Eave Designs

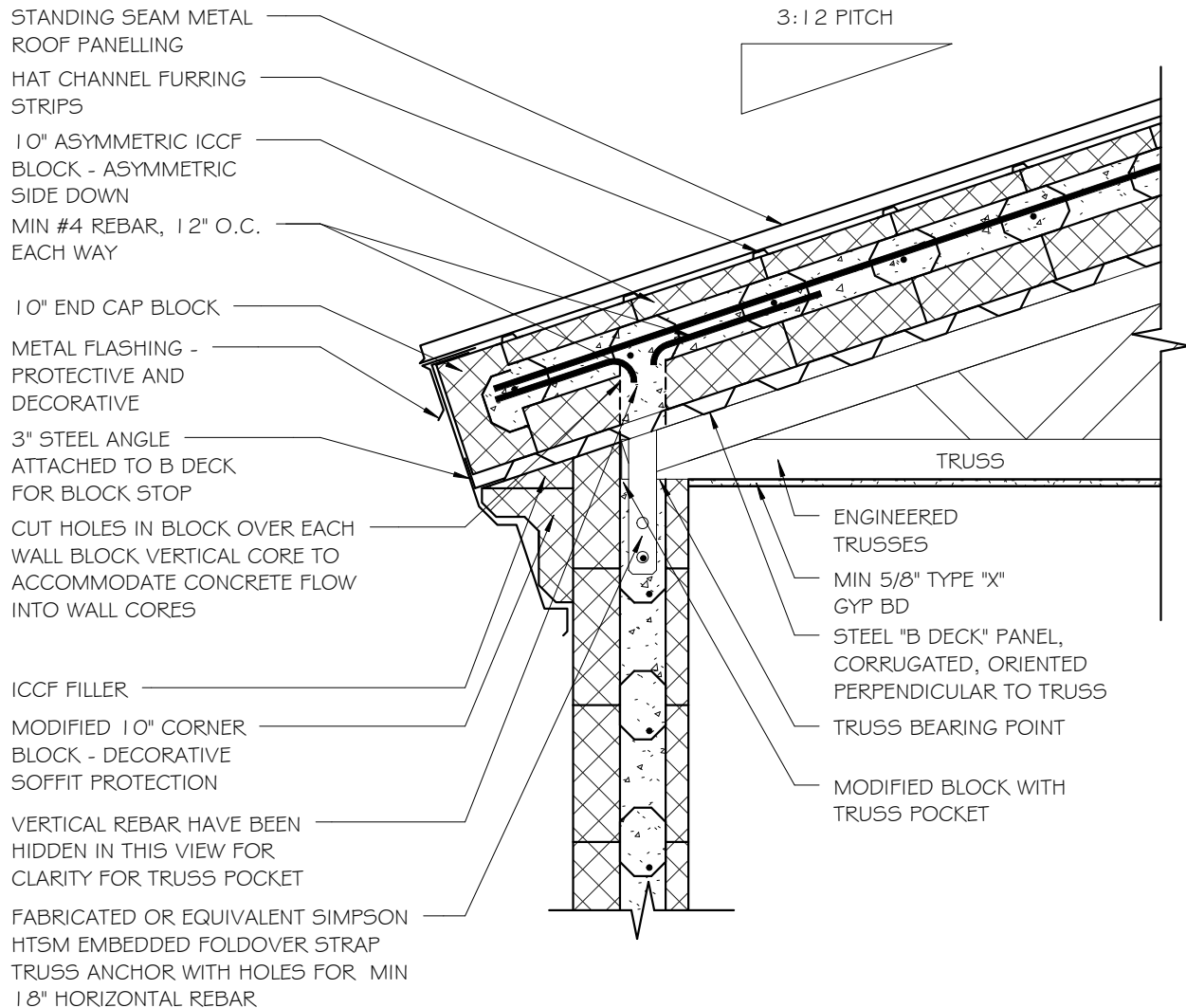

DETAIL FOR ICCF ROOF - FULL BLOCK -  
SUPPORT ON STEEL PAN DECK & ICCF  
WALL & WALL POCKET SUPPORTED  
TRUSSES - UNEXPOSED TRUSSES

FIREPROOF ROOF DETAIL - FULL BLOCK

SCALE: 3/4" = 1'-0"

## WALL CONSTRUCTION - FIREPROOF ICCF ROOF AND EAVE

### Fireproof ICCF Roof and Eave Designs

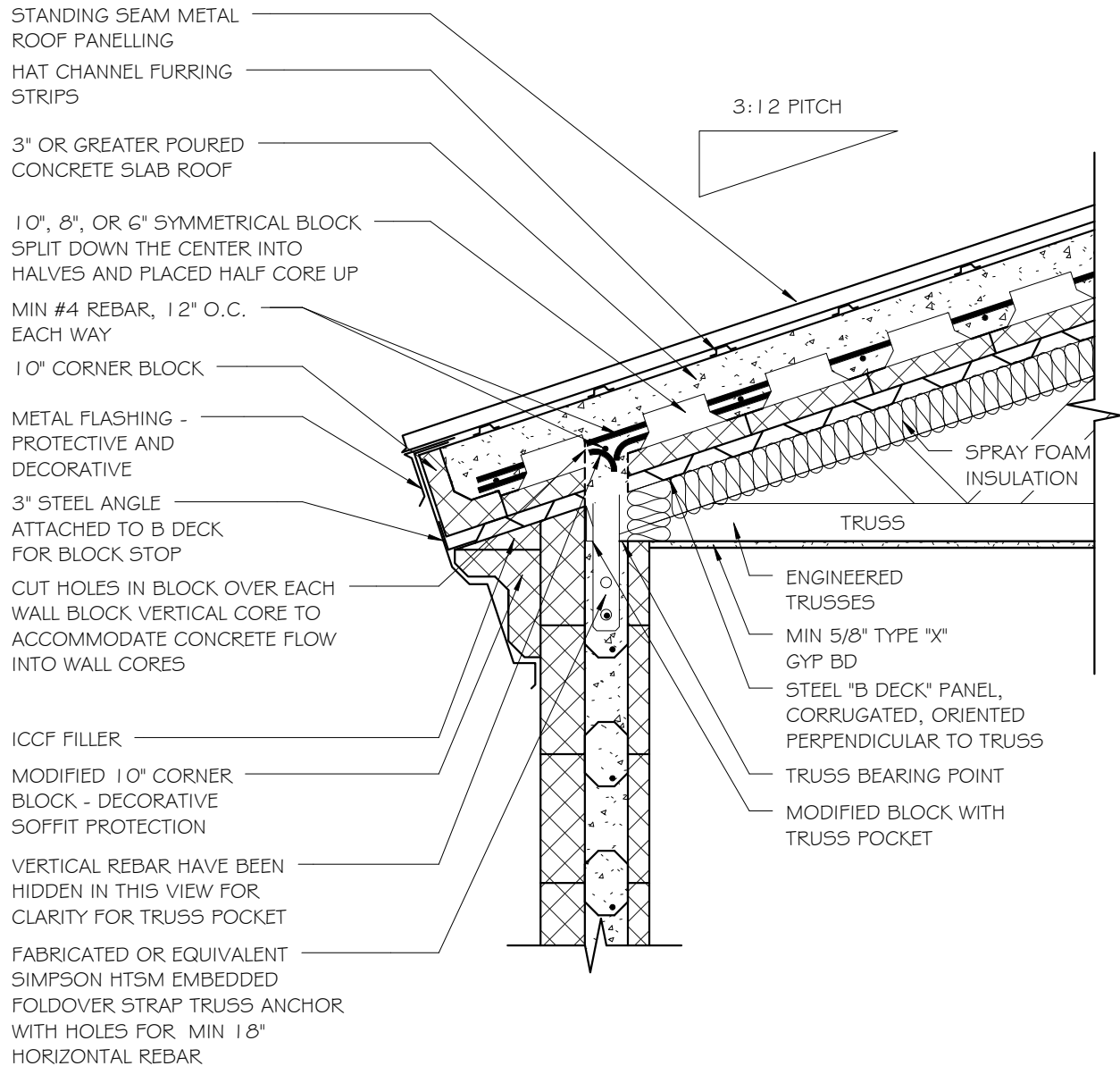

DETAIL FOR ICCF ROOF - CONCRETE SLAB ON  
 HALF BLOCK - SUPPORT ON STEEL PAN DECK &  
 ICCF WALL & WALL POCKET SUPPORTED  
 TRUSSES - UNEXPOSED TRUSSES  
 FIREPROOF ROOF - CONC SLAB W HALF BLOCK

SCALE: 3/4" = 1'-0"

## WALL CONSTRUCTION - FIREPROOF ICCF ROOF AND EAVE

### Fireproof ICCF Roof and Eave Designs

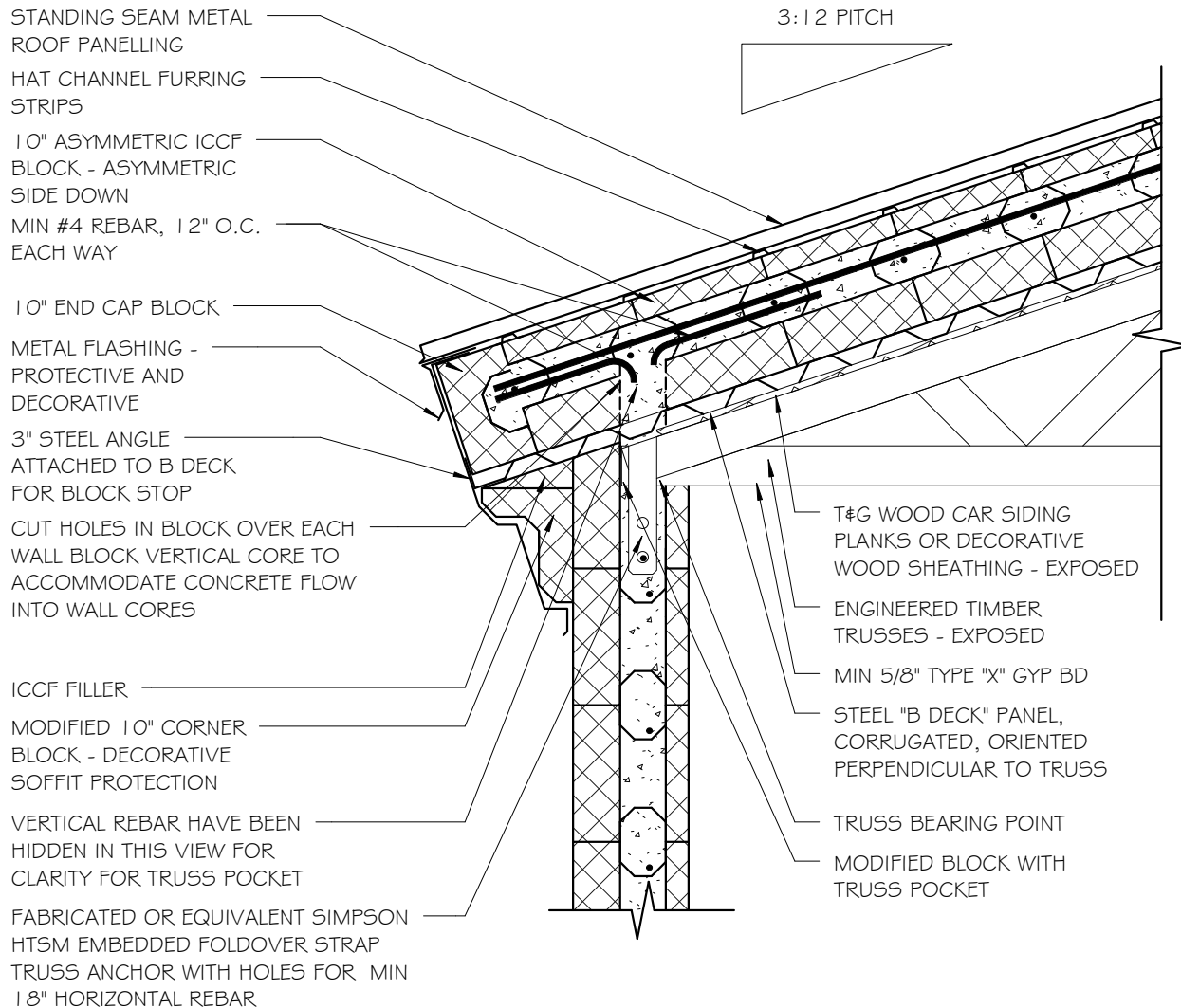

DETAIL FOR ICCF ROOF - FULL BLOCK -  
SUPPORT ON STEEL PAN DECK & ICCF WALL &  
WALL POCKET SUPPORTED TIMBER TRUSSES -  
EXPOSED TRUSSES

FIREPROOF ROOF DETAIL - EXPOSED TRUSSES

SCALE: 3/4" = 1'-0"

## WALL CONSTRUCTION - FIREPROOF ICCF ROOF AND EAVE

### Fireproof ICCF Flat Roof

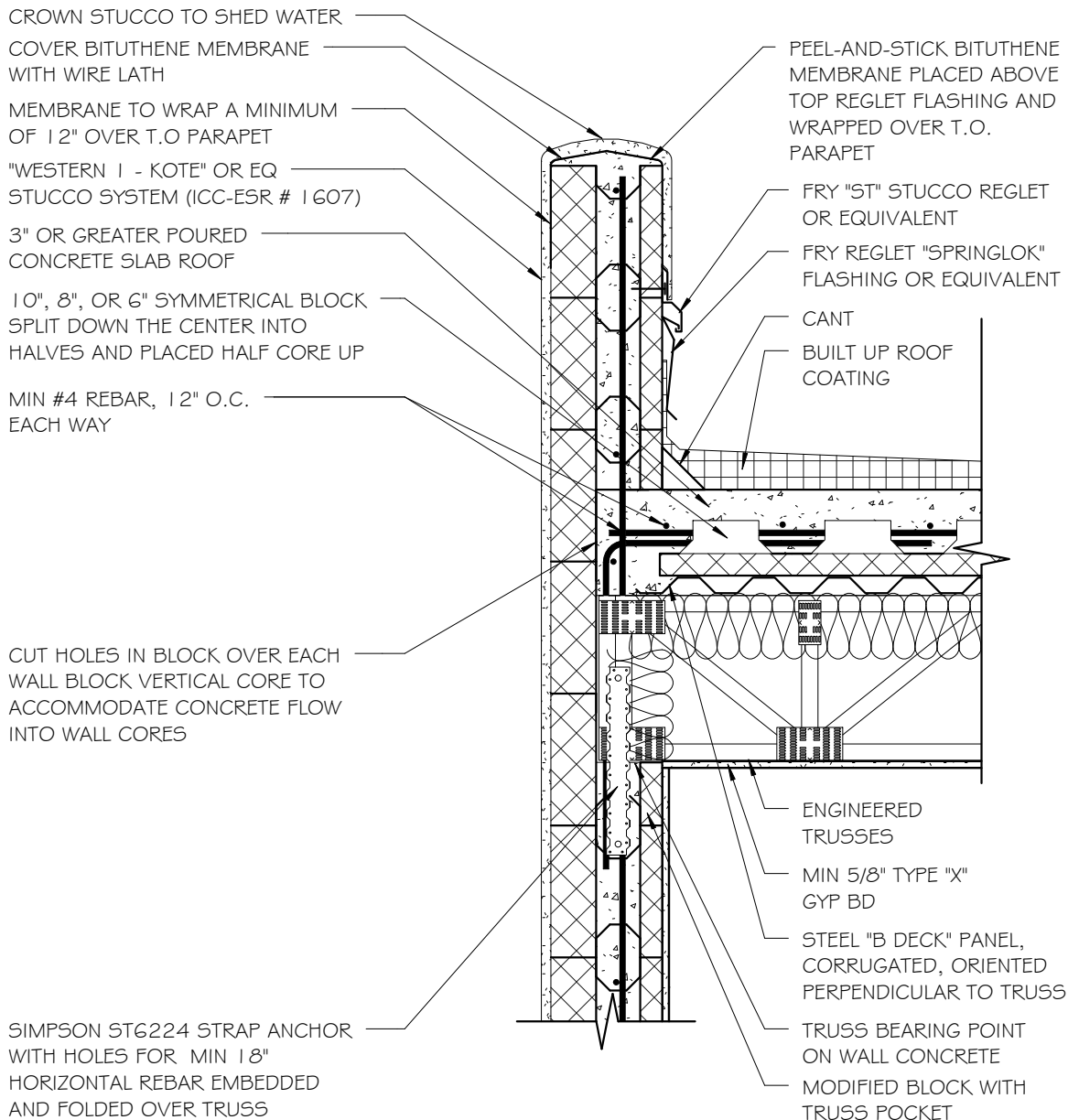

DETAIL FOR FLAT ICCF ROOF - CONCRETE  
 SLAB ON HALF BLOCK - SUPPORT ON STEEL  
 PAN DECK & ICCF WALL & WALL POCKET  
 SUPPORTED TRUSSES  
 FIREPROOF FLAT ROOF - CONC W/ HALF BLOCK

SCALE: 3/4" = 1'-0"

## B-Deck Concrete Floor Photo Examples

### Root Cellar



## **EPILOGUE**

Now that you have read this manual cover to cover, you are ready to tackle any ICCF building project. Right? Maybe, maybe not. We anticipate you having questions and we would love to hear from you if you do. Check our website: [theperfectblock.com](http://theperfectblock.com) for current contact information and call or email us for anything you need.

We are in the support and solution business when it comes to ICCF. If you choose us for your next building project, there is a whole lot more than just this building manual available to you to ensure a successful build. We will always be available on the phone if you need immediate guidance. ICCF building training is available for no charge at our facility in Peoria, AZ. Please contact us if more specific help is needed from the start to the finish of your project.

By the way, we would love see any photos or videos of your projects from beginning, during, and completion that you would like to share. And if you find other unique and innovative ways to use our building products, we would love to see them. Send pictures. We love pictures!

Happy Building!

Thank you from all the staff at Eco Building Systems Corp.